

**DOT MATRIX
LIQUID CRYSTAL DISPLAY
MODULE**

HTM0802B

USER' MANUAL

PROPOSED BY		APPROVED
Design	Approved	

CONTENTS

	PAGE
1. Mechanical Specification	2
2 Mechanical Diagram	2
3. Interface Pin Connections	2
4. Block Diagram	2
5. Absolute Maximum Rating	3
6. Electrical Characteristics	
3	
7. Optical Characteristics	3
8. Optical Definitions	3
9. Display Address	3
10. Interface to MPU	4
10.1Interface to Z-80 CPU	4
10.2Interface to MC6800 CPU	4
10.3Interface to 4-bit CPU (HMCS43C)	4
10.4Interface to HD6805 MP	4
11. Timing Control	4
11.1Write and Read Operation	4
11.2Busy flag check timing	
4	
12. Initialization of LCM	5
13. Instruction Set	6
14. User Font Patterns	6
15. Software Example	7
15.18-bit operation (8 bits 2 lines)	7
15.24-bit operation (4 bits 2 lines)	7
16. Reliability Condition	8
17. Function Test & Inspection Criteria	8
18 Character Generator ROM Map	10

1. Mechanical Specification

ITEM	STANDARD VALUE			UNIT
NUMBER OF CHARACTERS	8 CHARACTERS x 2 LINES			--
CHARACTER FORMAT	5 x 8 DOTS			--
MODULE DIMENSION	58.0 (W) x 32.0 (H) x 9.5MAX.			mm
VIEWING DISPLAY AREA	38.0 (W) x 16.0 (H)			mm
ACTIVE DISPLAY AREA	27.81(W) x 11.5 (H)			mm
CHARACTER SIZE	2.95 (W) x 5.55 (H)			mm
CHARACTER PITCH	3.55 (W) x 5.95 (H)			mm
DOT SIZE	0.55 (W) x 0.65 (H)			mm
DOT PITCH	0.6 (W) x 0.7 (H)			mm
EL Use Inverter Type				
Inverter Input				
Inverter Output				
Backlight Half-Lift Time				
LED Backlight Color				
Backlight Input	5.0	V	10	mA
Backlight Half-Lift Time		-		HR.
E Mode LED Backlight Color				
Backlight Input	-	V	-	mA
Backlight Half-Lift Time		-		HR.

2. Mechanical Diagram

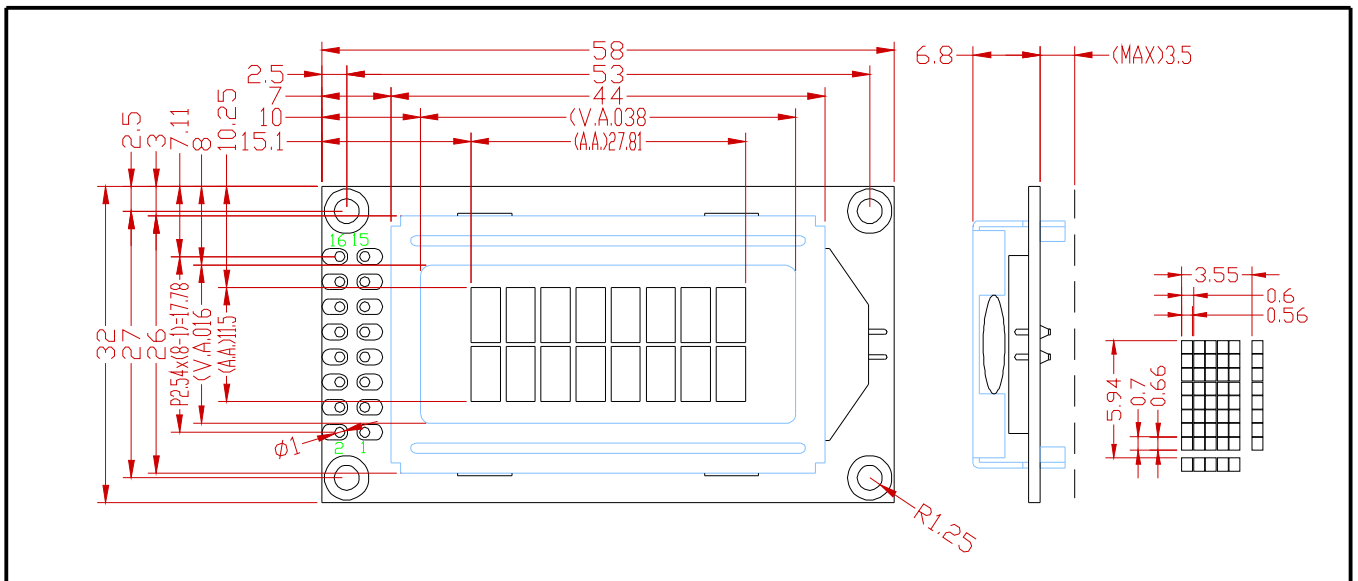

3. Interface Pin Connections

NO	SYMBOL	LEVEL	FUNCTION
1	VSS	--	GND (0V)
2	VDD	H/L	DC +5V
3	VO	H/L	Contrast Adjust
4	RS	H/L	Register select
5	R/W	H/L	Read/Write
6	E	H,H→L	Enable signal
7	DB0	H/L	Data Bit 0
8	DB1	H/L	Data Bit 1
9	DB2	H/L	Data Bit 2
10	DB3	H/L	Data Bit 3
11	DB4	H/L	Data Bit 4
12	DB5	H/L	Data Bit 5
13	DB6	H/L	Data Bit 6
14	DB7	H/L	Data Bit 7
15	LEDA	3.3V	Backlight +
16	LEDK	VSS	Backlight -

4. Block Diagram

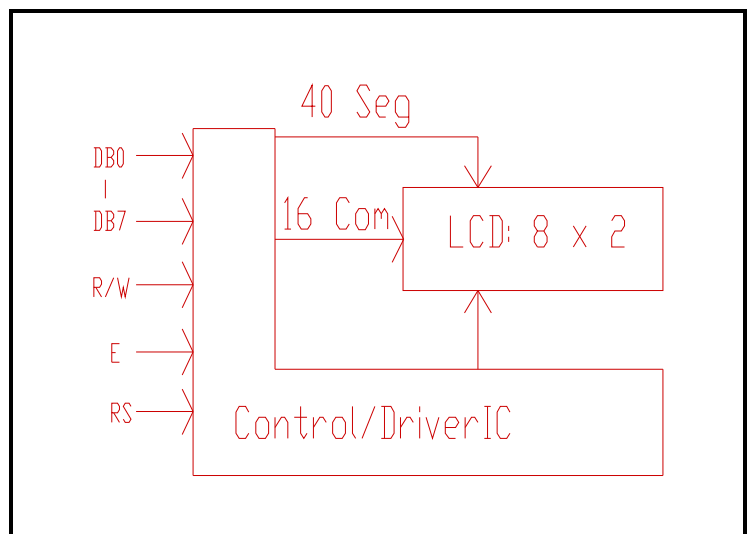

5. Absolute Maximum Ratings

ITEM	SYMBOL	MIN.	TYPE	MAX.	UNIT
OPERATING TEMPERATURE	TOP	0	--	+50	°C
STORAGE TEMPERATURE	TST	-10	--	+60	°C
INPUT VOLTAGE	VI	VSS	--	VDD	V
SUPPLY VOLTAGE FOR LOGIC	VDD-VSS	4.5	5.0	6.5	V
SUPPLY VOLTAGE FOR LCD	VDD-VO	--	--	6.5	V
STATIC ELECTRICITY	Be sure that you are grounded when handing LCM.				

6. Electrical Characteristics

ITEM	SYN	CONDITION	MIN.	TYPE	MAX.	UNIT
SUPPLY VOLTAGE FOR LOGIC	VDD-VSS	--	4.5	5.0	5.5	V
SUPPLY VOLTAGE FOR LCD	VDD-VO	Ta= 0/-20 °C	--	4.8/5.0	--	V
		Ta= 25°C	--	4.4	--	V
		Ta= +50/+70 °C	--	4.1/3.9	--	V
INPUT HIGH VOLTAGE	VIH	--	2.2	--	VDD	V
INPUT LOW VOLTAGE	VIL	--	0	--	0.6	V
OUTPUT HIGH VOLTAGE	VOH	--	2.4	--	--	V
OUTPUT LOW VOLTAGE	VOL	--	--	--	0.4	V
SUPPLY CURRENT	IDD	VDD=+5V	--	1.0	2.0	mA

7. Optical Characteristics

ITEM	SYM	CONDITION	MIN.	TYPE	MAX.	UNIT
VIEW ANGLE (V)	θ	CR \geq 2	-10	--	40	deg.
VIEW ANGLE (H)	φ	CR \geq 2	-30	--	30	deg.
CONTRAST RATIO	CR	--	--	5	--	--
RESPONSE TIME	TON	--	--	180	230	mS
RESPONSE TIME	TOFF	--	--	100	150	mS

8. Optical Definitions

Response Time

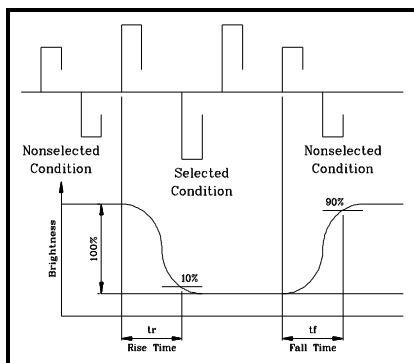

Contrast Ration

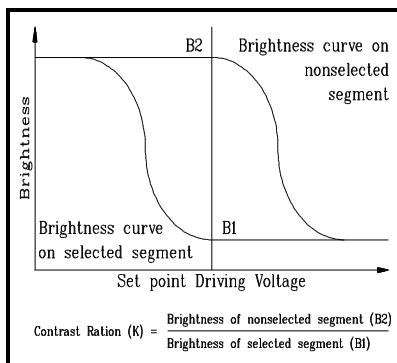

View Angle

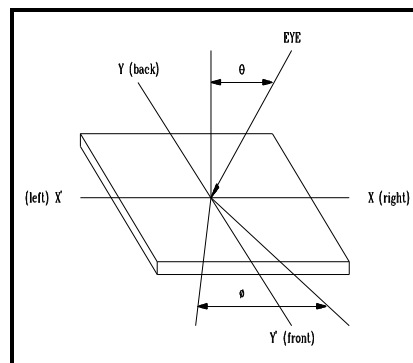

9. Display Address

	1	2	3	4	5	6	7	8
Line 1	80	81	82	83	84	85	86	87
Line 2	C0	C1	C2	C3	C4	C5	C6	C7

10. Interface to MPU

10.1 Interface to Z-80 CPU

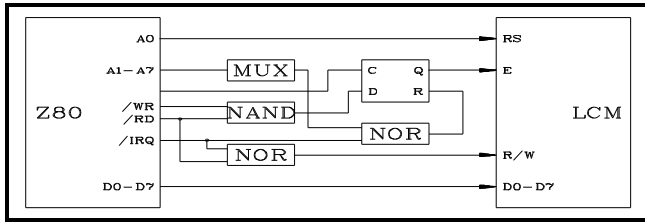

10.2 Interface to MC6800 CPU

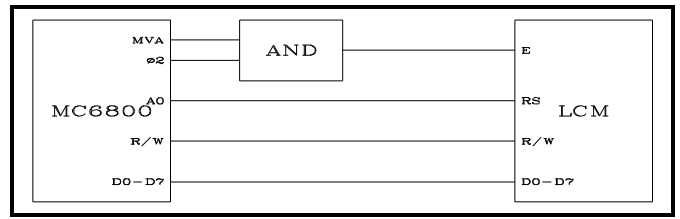

10.3 Interface to 4-bit CPU (HMCS43C)



10.4 Interface to HD6805 MP

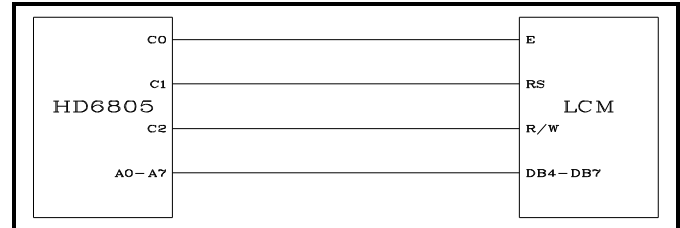

11. Timing Control

11.1 Write and Read Operation

Write Operation

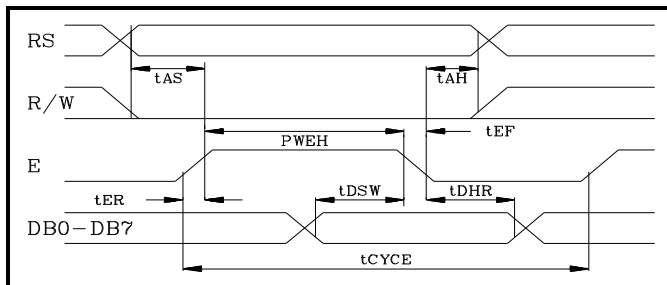

Read Operation

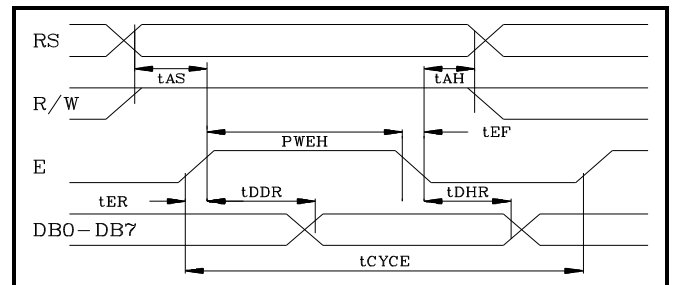

Item	Symbol	Limit (Min.)	Limit (Max.)	Unit
Enable Cycle Time	tCYCE	1000	--	ns
Enable Pules Width (High level)	PWEH	450	--	ns
Enable Rise/Fall Time	tER,tEF	--	25	ns
Address Set-Up Time (RS,R/W,E)	tAS	100	--	ns
Address Hole Time	tAH	10	--	ns
Data Set-Up Time	tDSW	100	--	ns
Data Delay Time	tDDR	--	190	ns
Data Hold Time	tDHR	20	--	ns

11.2 Busy flag check timing

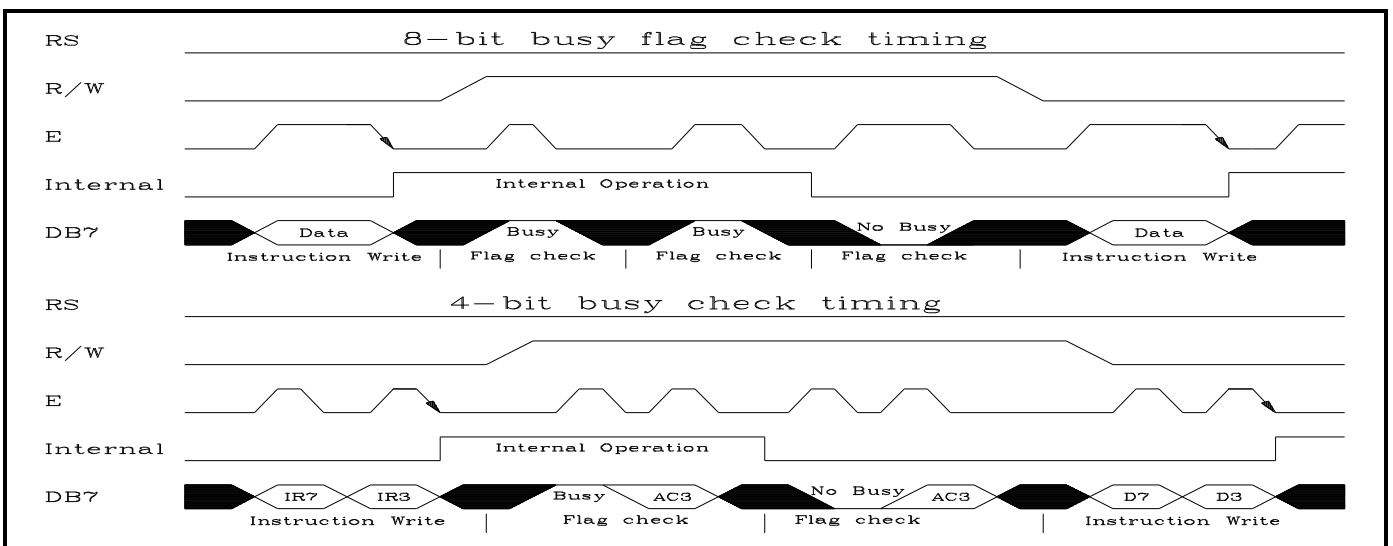

Note : IR7, IR3 : Instruction 7th bit , 3rd bit ; AC3 : Address Counter 3rd bit.

12. Initialization of LCM

The LCM automatically initializes (reset) when power is turned on using the internal reset circuit. If the power supply conditions for correctly operating of the internal reset circuit are not met, initialization by instruction is required. Use the procedure is next page for initialization.

Internal Power Supply reset

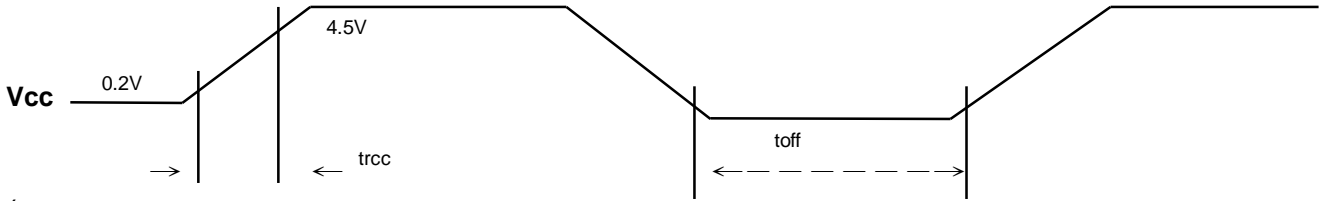

(Note 1) $10\text{ ms} \geq trcc \geq 0.1\text{ ms}$, $toff \geq 1\text{ ms}$.

(Note 2) toff stipulates the time of power OFF for momentary power supply dip or when power supply cycles ON and OFF.

Item	Symbol	Test condition	Limit (Min.)	Limit (Max.)	Unit
Power supply rise time	trcc	--	0.1	10	ms
Power supply off time	toff	--	1	--	ms

1) 8 Bit Interface

2) 4 Bit Interface

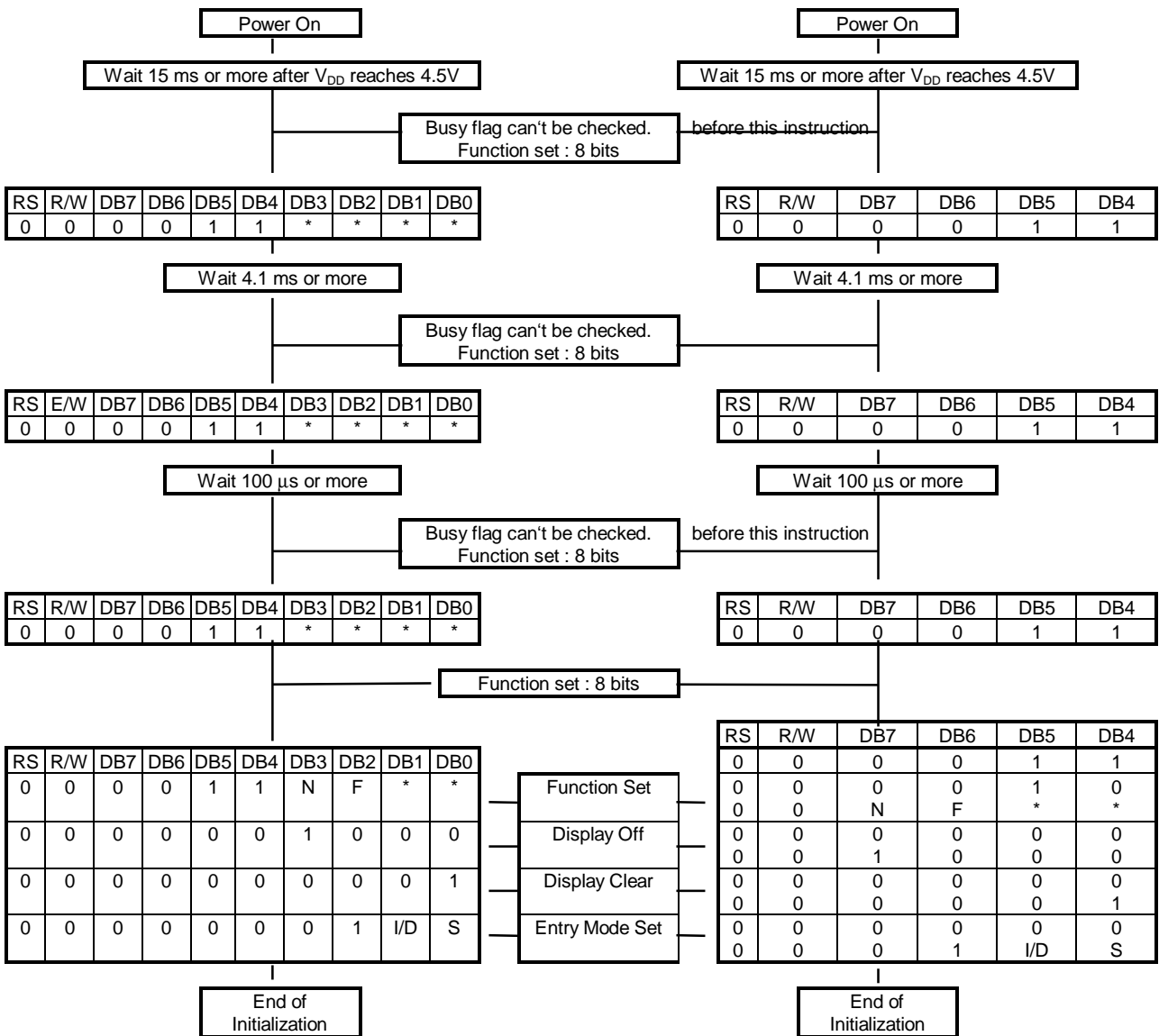

I Busy flag is checked after instructions are completed. If busy flag isn't checked, the waiting time between instructions should be longer than execution time of these instructions.

FUNCTION	R S	R /W	D B 7	D B 6	D B 5	D B 4	D B 3	D B 2	D B 1	D B 0	DESCRIPTION	EXECU. TIME* (MAX.)
Clear Display	0	0	0	0	0	0	0	0	0	1	Clears entire display and returns the cursor to home position (address 0).	1.64ms
Return Home	0	0	0	0	0	0	0	0	1	x	Return the cursor to the home position. Also returns the display being shifted to the original position. DD RAM contents remain unchanged.	1.64ms
Entry mode set	0	0	0	0	0	0	0	1	I / D	S	Set cursor move direct and specifies display shift. These operations are performed during data write/read. For normal operation, set S to zero. I/D=1 : increment ; 0 :decrement ; S=1 : accompanies display shift when data is written, for normal operation, set to zero.	40 μs
Display ON/OFF control	0	0	0	0	0	0	1	D	C	B	Set ON/OFF all display(D), cursor ON/OFF(C), and blink of cursor position character(B). D=1: ON display; 0:OFF display. C=1: ON cursor;0: OFF cursor. B=1: ON blink cursor; 0: OFF blink cursor.	40 μs
Cursor or Display shift	0	0	0	0	0	1	S / C	R / L	x	x	Move the cursor and shift the display without changing DD RAM contents. S/C=1: Display shift; 0:Cursor move. R/L=1: shift to right; 0: shift to left.	40 μs
Function Set	0	0	0	0	1	D L	N	F	x	x	Set the interface data length (DL). Number of display lines (N) and character font (F). DL=1: 8 bits; 0:4 bits. N=1: 2 lines; 0: 1 lines. F=1: 5x10 dots; 0: 5x7 dots.	40 μs
Set CG RAM address	0	0	0	1	ACG					Set CG RAM address. CG RAM data is sent and received after this setting.		40 μs
Set DD RAM address	0	0	1	ADD					Set DD RAM address. DD RAM data is sent and received after this setting		40 μs	
Read busy flag & address	0	1	B F	AC					Reads Busy Flag (BF) indicating internal operation is being performed and reads address counter contents. BF=1: internally operating. 0: can accept instruction		1 μs	
Write Data to CG/DDRAM	1	0	WRITE DATA					Write data into DD RAM or CG RAM.		40 μs		
Read Data for CG/DDRAM	1	1	READ DATA					Read data from DD RAM or CG RAM		40 μs		

14. User Font Patterns (CG RAM Character)

Character Code (DD RAM data)			CG RAM Address		Character Pattern (CG RAM data)						
Hi	7 6 5 4 3 2 1 0	Lo	5 4 3	2 1 0	Hi	7 6 5	4 3 2 1 0	Lo			
0000x000				000	xxx	1 1 1 1 0					
				001	xxx	1 0 0 0 1					
				010	xxx	1 0 0 0 1					
			000	011	xxx	1 1 1 1 0					
				100	xxx	1 0 1 0 0					
				101	xxx	1 0 0 1 0					
				110	xxx	1 0 0 0 1					
				111	xxx	0 0 0 0 0					
0000x001				000	xxx	1 0 0 0 1					
				001	xxx	0 1 0 1 0					
				010	xxx	1 1 1 1 1					
			001	011	xxx	0 0 1 0 0					
				100	xxx	1 1 1 1 1					
				101	xxx	0 0 1 1 0					
				110	xxx	0 0 1 0 0					
				111	xxx	0 0 0 0 0					
0000x111				000							
				001							
				010							
			111	011							
				100							
				101							
				110							
				111							

15. Software Example

15.1 8-bit operation (8 bits 2 lines)

Function	R S	R w	D 7	D 6	D 5	D 4	D 3	D 2	D 1	D 0	Display	Description
Power on delay												Initialization. No display appears.
Function set	0	0	0	0	1	1	0	0	x	x		Sets to 8-bit operation and selects 2-line display and 5x7 dots character font. (Note: number of display lines and character fonts cannot be changed after this.)
Display OFF	0	0	0	0	0	0	1	0	0	0		Turn off display.
Display ON	0	0	0	0	0	0	1	1	1	0	_	Turn on display and cursor
Entry Mode Set	0	0	0	0	0	0	0	1	1	0	-	Set mode to increment the address by one and to shift the cursor to the right, at the time of write, to the DD/CG RAM Display is not shifted.
Write data to CG/DD RAM	1	0	0	1	0	1	0	0	1	1	S_	Write "S". Cursor incremented by one and shift to right.
Write data to CG/DD RAM	1	0	0	1	0	0	0	1	0	0	SDEC_	Write "D" , "E" , and "C".
Write data to CG/DD RAM	1	0	0	1	0	0	0	0	1	1		
Set DD RAM	0	0	1	1	0	0	0	0	0	0	SDEC_	Set RAM address so that the cursor is positioned at the head of the second line.
Write data to CG/DD RAM			*	*							SDEC CR_	Write "C" , and "R".
Cursor or display shift	0	0	0	0	0	1	0	0	x	x	SDEC CR	Shift only the cursor position to the left.
Write data to CG/DD RAM			*	*							SDEC CO., LTD._	Write "O., LTD." .
Entry Mode Set	0	0	0	0	0	0	0	1	1	1	SDEC CO., LTD._	Set display mode shift at the time during writing operation.
Write data to CG/DD RAM	1	0	0	1	1	1	0	0	0	0	DEC O., LTD. x_	Write " x". Cursor incremented by one and shift to right. (The display move to left.)
Write data to CG/DD RAM			*	*								Write other characters.
Return Home	0	0	0	0	0	0	0	0	1	0	SDEC CO., LTD.	Return both display and cursor to the original position (Set address to zero).

15.2 4-bit operation (4-bit, 1 line)

Function	RS	R/ W	D7	D6	D5	D4	Display	Description
power on delay								initialization. No display appears.
Function set	0	0	0	0	1	0		Sets to 4-bit operation. In this case, operation is handled as 8-bits by initialization, and only this instruction completes with one write.
Function set	0	0	0	0	1	0		Sets 4-bit operation and selects 1-line display and 5x7 dot character font on and resetting is needed. (number of display lines and character fonts cannot be changed hence after).
Function set	0	0	0	0	x	x		
Display ON/OFF Control	0	0	0	0	0	0	-	Turn on display and cursor.
Display ON/OFF Control	0	0	1	1	1	0		
Entry Mode Set	0	0	0	0	0	0	-	Set mode to incremented the address by one and to shift the cursor to the right, at the time of write. to the DD/CG RAM display is not shifted.
Entry Mode Set	0	0	0	1	1	0		
Write data to CG/DD RAM	1	0	0	1	0	1	S_	Write "S". Cursor incremented by one and shift to right.
Write data to CG/DD RAM	1	0	0	0	1	1		
same as 8-bit operation								

		TN Type		STN Type		
		Normal Temp.	Wide Temp.	Normal Temp.	Wide Temp.	
Viewing Angle	Horizontal Φ	$\pm 30^\circ$	$\pm 30^\circ$	$\pm 30^\circ$	$\pm 30^\circ$	
	Vertical Θ (mm)	10° to 30°	10° to 30°	-10° to 40°	-10° to 40°	
Operating Temperature		-10 to 70°C	-25 to 80°C	0 to 50°C	*-20 to 70°C	
Storage Temperature		-20 to 80°C	-35 to 90°C	-20 to 70°C	*-30 to 80°C	
High Temperature (Power Off)		240 Hours @70°C	240 Hours @90°C	240 Hours @65°C	240 Hours @75°C	
Low Temperature (Power Off)		240 Hours @-20°C	240 Hours @-35°C	240 Hours @-15°C	240 Hours @-25°C	
High Temperature (Power On)		240 Hours @70°C	240 Hours @80°C	240 Hours @60°C	240 Hours @70°C	
Low Temperature (Power On)		240 Hours @-10°C	240 Hours @-25°C	240 Hours @-10°C	240 Hours @-20°C	
High Temperature & High Humidity		55°C/90%RH 240 Hours	75°C/90%RH 240 Hours	45°C/90%RH 240 Hours	65°C/90%RH 240 Hours	
Thermal Shock 5 Cycle		A	60min@-20°C	60min@-35°C	60min@-20°C	60min@-30°C
		B	5min@25°C	5min@25°C	5min@25°C	5min@25°C
		C	60min@70°C	60min@90°C	60min@70°C	60min@80°C
Expected Lift		50,000 Hours	50,000 Hours	50,000 Hours	50,000 Hours	

Wide temp. version may not available for some products, Please consult our sales engineer or representative.

17. Functional Test & Inspection Criteria

17.1 Sample plan

Sample plan according to MIL-STD-105D level 2, and acceptance/rejection criteria is.

Base on : Major defect : AQL 0.65 Minor defect : AQL 2.5

17.2 Inspection condition

Viewing distance for cosmetic inspection is 30cm with bare eyes, and under an environment of 800 lus (20W) light intensity. All direction for inspecting the sample should be within 45° against perpendicular line.

17.3 Definition of Inspection Zone in LCD

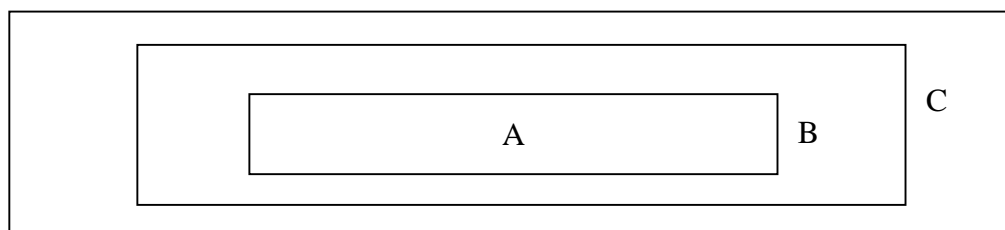

Zone A : Character / Digit area

Zone B : Viewing area except Zone A (Zone A + Zone B = minimum Viewing area)

Zone C : Outside viewing area (invisible area after assembly in customer's product)

Note : As a general rule, visual defects in Zone C are permissible, when it is no trouble for quality and assembly of customer's product.

17.4 Major Defect

All functional defects such as open (or missing segment), short, contrast differential, excess power consumption, smearing, leakage, etc. and overall outline dimension beyond the drawing. Are classified as major defects.

17.5 Minor Defect

Except the Major defects above, all cosmetic defects are classified as minor defects.

Item No.	Item to be Inspected	Inspection Standard			Classification of defects		
1.	Spot defect (Defects in spot from)	Zone size (mm)	Acceptable Qty			Minor	
			A	B	C		
		$\Phi \leq 0.15$	Acceptable (clutering of spot not allowed)		Acceptable		
		$0.15 \leq \Phi \leq 0.20$	1	2			
		$0.20 \leq \Phi \leq 0.25$	0	1			
		$\Phi > 0.25$	0	0			
Remarks : for dark/white spot, size Φ is defined as $\Phi = 1/2(X+Y)$							
2.	Line defect (Defects in line form)	Size (mm)		Acceptable Qty		Minor	
		L	W	Zone			
		Length	Width	A	B		C
		Acceptable	$W \leq 0.02$	Acceptable	Acceptable		
		$L \leq 3.0$	$W \leq 0.03$	2			
		$L > 2.5$	$W \leq 0.03$	0			
		$L \leq 3.0$	$0.03 < W \leq 0.05$	2			
		$L > 2.5$	$0.03 < W \leq 0.05$	0			
			$W > 0.05$	Counted as spot defect (Follows item 17.5.1)			
Remarks: The total of spot defect and line defect shall not exceed four.							
3.	Orientation defect (such as misalignment of L/C)	Not allowed inside viewing area (Zone A or Zone B)			Minor		
4.	Polarizing	17.5.4.1 Polarizer Position				Minor	
		1. Shifting in Position Should not exceed the glass outline dimension.					
		2. Incomplete covering of the viewing area due to Shifting is not allowed.					
		17.5.4.2 Seratches, bubble or dent on Glass/ Polarizer/Reflector, Bubble between Polarizer & Reflector/Glass:					
		Size (mm)	Acceptable Qty				
			Zone				
			A	B	C		
		$\Phi \leq 0.20$	Acceptable		Acceptable		
$0.20 < \Phi \leq 0.50$	3						
$0.50 < \Phi \leq 1.00$	2						
$\Phi > 1.00$	0						

CHARACTER PATTERN CHART (5x7 DOTS +CURSOR)

Higher 4 bit Lower 4 bit	0000	0010	0011	0100	0101	0110	0111	1010	1011	1100	1101	1110	1111
XXXX0000	CG RAM (1)		0	a	P	`	F		-	9	3	0	P
XXXX0001	(2)	!	1	A	Q	a	9	o	7	7	4	ä	Q
XXXX0010	(3)	"	2	B	R	b	r	「	イ	ツ	×	ß	θ
XXXX0011	(4)	#	3	C	S	c	s	」	ウ	テ	ε	ε	ω
XXXX0100	(5)	\$	4	D	T	d	t	,	イ	ト	ト	μ	Ω
XXXX0101	(6)	%	5	E	U	e	u	.	オ	ナ	1	ε	ü
XXXX0110	(7)	&	6	F	V	f	v	ヲ	カ	ニ	ヨ	ρ	Σ
XXXX0111	(8)	'	7	G	W	g	w	ア	キ	ヌ	ラ	q	π
XXXX1000	(1)	(8	H	X	h	x	ィ	ウ	ネ	リ	5	×
XXXX1001	(2))	9	I	Y	i	y	ウ	ケ	ル	ル	'	4
XXXX1010	(3)	*	:	J	Z	j	z	エ	コ	ン	口	i	千
XXXX1011	(4)	+	;	K	[k	(オ	サ	ヒ	ク	*	万
XXXX1100	(5)	,	<	L	¥	l	l	カ	シ	フ	ン	φ	円
XXXX1101	(6)	-	=	M]	m)	ユ	ズ	ン	ン	も	÷
XXXX1110	(7)	.	>	N	^	n	ヲ	ヨ	セ	ホ	°	ñ	
XXXX1111	(8)	/	?	O	_	o	←	ッ	リ	マ	°	ö	■