



ACVATIX™

Electromotoric rotary actuators for butterfly or slipper valves

SAL..

with 90° rotary angle

-
- SAL31.. Operating voltage AC 230 V, 3-position control signal
 - SAL61.. Operating voltage AC/DC 24 V, control signal 0...10 V, 4...20 mA, 0...1000
 - SAL81.. Operating voltage AC/DC 24 V, 3-position control signal
 - SAL61.. Position feedback, override control
 - For direct mounting on butterfly or slipper valves; no adjustments required
 - Manual adjuster, position indicator and status indication with LED
 - Optional functions with auxiliary switches, potentiometer

Use

For the operation of Siemens butterfly and slipper valves, types VKF41..., VKF46..., and VBF21.. as control or shutoff valves in heating, ventilation and air conditioning systems.

Type summary

Product no.	Stock no.	Angular rotation	Torque	Operating voltage	Positioning signal	Positioning time	LED	Manual adjuster	Extra functions	
SAL31.00T10	S55162-A108	90°	10 Nm	AC 230 V	3-position	120 s	-	Push and fix	-	
SAL31.00T20	S55162-A110		20 Nm			30 s				
SAL31.03T10	S55162-A109		10 Nm	AC/DC 24 V	DC 0...10 V DC 4...20 mA 0...1000	120 s	✓			Position feedback, forced control
SAL61.00T10	S55162-A100		20 Nm			30 s				
SAL61.03T10	S55162-A101		10 Nm		3-position	120 s	-			
SAL81.00T10	S55162-A104		20 Nm			30 s				
SAL81.00T20	S55162-A106		20 Nm	120 s	-	-				
SAL81.03T10	S55162-A105		10 Nm	30 s						

Electrical accessories

Product no.	Auxiliary switch ASC10.51	Potentiometer ASZ7.5/.. ¹⁾
Stock no.	S55845-Z103	S55845-Z104 (ASZ7.5/135) S55845-Z105 (ASZ7.5/200) S55845-Z106 (ASZ7.5/1000)
Max. 2 in total		
SAL31..	Max. 2	Max. 1
SAL61..	Max. 2	-
SAL81..		Max. 1

¹⁾ Available with 135 , 200 or 1000

Mechanical accessories

Product no.	Weather shield ASK39.1	Mounting set		
		ASK31N for VBF21..	ASK33N for VKF41..	ASK35N for VKF45.. ¹⁾
Stock no.	S55845-Z109	S55845-Z100	S55845-Z101	S55845-Z102
SAL..T10	Max. 1	✓	✓	-
SAL..T20	Max. 1	-	-	DN40 .. DN65

¹⁾ Type VKF45.. was replaced by type VKF46.. in the year 2000

Ordering



Example

Product no.	Stock no.	Description	Quantity
SAL31.00T10	S55162-A108	Rotary actuator	1
ASZ7.5/1000	S55845-Z106	Potentiometer	1



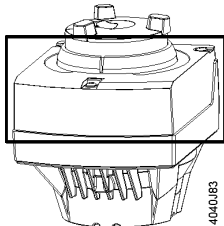

Delivery

Actuators, valves and accessories are supplied in individual packs.

Spare parts

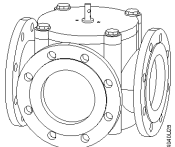
Stock number 8000060844	Housing cover 	
	2 adapters  1 pc. 14 mm 1 pc. 11 mm	
	4 screws  2 pcs. M5 x 20 mm 2 pcs. M6 x 20 mm	

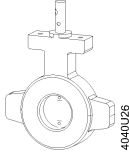
Combinations

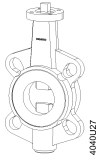
SAL..					SAL..T10	SAL..T20	
					Angular rotation Torque		
					90 °		
					10 Nm	20 Nm	
Slipper valves	Data Sheet	Valve type ¹	DN	k _{vs} [m ³ /h]	Mounting set	p _{max} [kPa]	
  1 °C...120 °C	N4241	VBF21.40	40	25	-	- ¹⁾	
		VBF21.50	50	40	-	- ¹⁾	
		VBF21.65	65	63	ASK31N	30	-
		VBF21.80	80	100	ASK31N		
		VBF21.100	100	160	ASK31N		
		VBF21.125	125	550	ASK31N		
		VBF21.150	150	820	ASK31N		
Butterfly valves						p _s [kPa]	
  -10 °C...120 °C	N4131	VKF41.40	40	50	ASK33N	500	-
		VKF41.50	50	80	ASK33N		
		VKF41.65	65	200	ASK33N		
		VKF41.80	80	400	ASK33N		
		VKF41.100	100	760	ASK33N		
		VKF41.125	125	1'000	ASK33N	300	-
		VKF41.150	150	2'100	ASK33N	250	-
		VKF41.200	200	4'000	ASK33N	125	-
  -10 °C...120 °C	N4136	VKF46.40	40	50	-	-	1'600
		VKF46.50	50	85	-		
		VKF46.65	65	215	-		
		VKF46.80	80	420	-		
		VKF46.100	100	800	-		
		VKF46.125	125	1'010	-	-	-

1) SAL..T10 rotary actuators only fit on VBF21..., DN65...150. For VBF21..., DN40/50 use SQK34..., SQK84.. (data sheet N4508) or SQK33.00 (data sheet N4506) rotary actuators.

Product documentation

Detailed information about the New Generation actuators can be found in the basic documentation "Electromotoric actuators SAX.., SAL.." (CE1P4040en).

Notes

Engineering

SAL 31.. / SAL81..

3-position actuators must have their own specific controller, refer to "Connection Diagrams" (page 7).

SAL61..

Up to 10 actuators can drive in parallel on a controller output with a rating of 1 mA. Modulating actuators have an input impedance of 100 kΩ.

Mounting

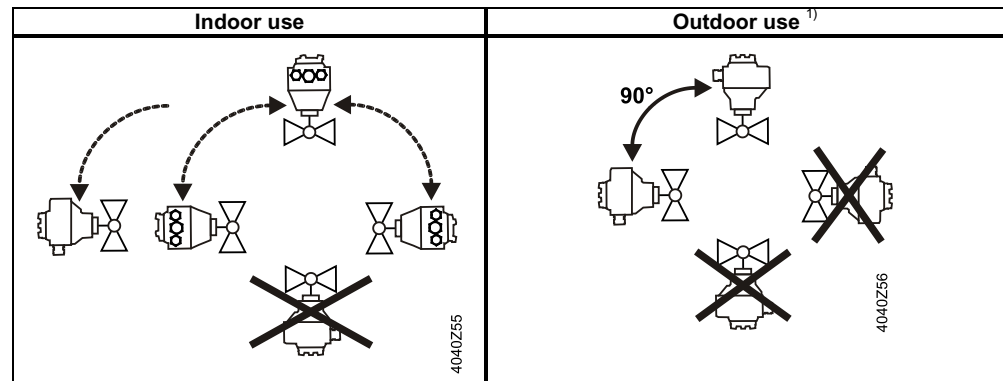

¹⁾ Only in connection with weather shield ASK39.1

Maintenance

The rotary actuators are maintenance-free.

Warranty

The engineering data specified in chapter "Combinations" (page 3) are only guaranteed in connection with the Siemens valves listed.

Note

When using the actuators in connection with slipper valves of other manufacture, correct functioning must be ensured by the user, and Siemens will assume no responsibility. The use of the rotary actuators SAL..T10 with butterfly valves is only permitted for the Siemens Series VKF41..

Technical Data

		SAL..
Power supply	Operating voltage SA..31.. SA..61.. SA..81..	AC 230 V ±15% AC 24 V ±20% / DC 24 V +20% / -15% AC 24 V ±20% / DC 24 V +20% / -15%
	Frequency	45...65 Hz
	Fusing ac. DIN 57 100 part 430 (supply lines)	6 A...10 A slow
	Power consumption at 50 Hz	
	SAL31.00T10 Rotary actuator turns	3,5 VA / 2 W
	SAL31.00T20 Rotary actuator turns	4,1 VA / 2,6W
	SAL31.03T10 Rotary actuator turns	6,5 VA / 2,75 W
	SAL61.00T10 Rotary actuator turns	4 VA / 2 W
	SAL61.00T20 Rotary actuator turns	5,8 VA / 2,6 W
	SAL61.03T10 Rotary actuator turns	8,5 VA / 3,5 W
	SAL81.00T10 Rotary actuator turns	4 VA / 2 W
	SAL81.00T20 Rotary actuator turns	4 VA / 2,6 W
	SAL81.03T10 Rotary actuator turns	4 VA / 3 W
Function data	Positioning times (with spec. nominal angular rotation)	
	SAL31.00.., SAL61.00.., SAL81.00..	120 s
	SAL31.03T10, SAL61.03T10, SAL81.03T10	30 s
	Torque	10 Nm running / min. 4 Nm holding
	SAL..T10	20 Nm running / min. 14 Nm holding
	SAL..T20	90°
	Rotary angle	90°
	Permissible medium temperature (valve fitted)	-10...120 °C
Signal inputs	Positioning signal "Y"	SAL31.., SAL81..
	SAL3..	Voltage
	SAL8..	Voltage
	SAL61.. (DC 0...10 V)	Current draw
	Input impedance	100 k
	SAL61.. (DC 4...20 mA)	Current draw
	Input impedance	500
Parallel operation	SAL61..	10 (depending on controller output)
Forced control	Positioning signal "Z"	SAL61..
	R = 0...1000	R = 0...1000 , G, G0
	Z connected to G	Stroke / rotation proportional to R
	Z connected to G0	90° ¹⁾
	Voltage	0° ¹⁾
	Current draw	Max. AC 24 V ±20%
		Max. DC 24 V +20% / -15%
		0.1 mA

Position feedback	Position feedback U SAL61.. Load impedance Load	DC 0...10 V ± 1% >10 k res. Max. 1 mA
Connecting cable	Wire cross-sectional areas	0.75...1.5 mm ² , AWG 20...16 ²⁾
Connecting cable	Cable entries	2 entries Ø 20.5 mm (for M20) 1 entry Ø 25.5 mm (for M25)
Degree of protection	Housing from vertical to horizontal	IP54 as per EN 60529 ³⁾
	Insulation class SAL31.. AC 230 V SAL61.. AC / DC 24 V SAL81.. AC / DC 24 V	As per EN 60730 II III III
Environmental conditions	Operation Climatic conditions Mounting location Temperature Humidity (noncondensing)	IEC 60721-3-3 Class 3K5 Indoors (weather-protected) -15...55 °C 5...95 % r.h.
	Transport Climatic conditions Temperature Humidity	IEC 60721-3-2 Class 2K3 -25...70 °C <95 % r.h.
	Storage Temperature Humidity	IEC 60721-3-1 -15...55 °C 5...95 % r.h.
	Max. media temperature when mounted on valve	120 °C
Standards	CE conformity As per EMC directive Immunity Emissions	2004/108/EC EN 61000-6-2:[2005] Industrial ⁴⁾ EN 61000-6-3:[2007] Residential
	Electrical safety	EN 60730-1
	Low-voltage directive AC 230 V	2006/95/EC
	C-tick	N 474
	UL conformity AC 230 V AC/DC 24 V	- UL 873
Environmental compatibility	-	ISO 14001 (environment) ISO 9001 (quality) SN 36350 (environment-compatible products) RL 2002/95/EG (RoHS)
Dimensions	-	See "Dimensions" (page 8)
Weight	Excl. packaging	See "Dimensions" (page 8)
Accessories	Potentiometer ASZ7.5/135 Voltage Current rating	0...135 ± 5% DC 10 V <4 mA
	Potentiometer ASZ7.5/200 Voltage Current rating	0...200 ± 5% DC 10 V <4 mA
	Potentiometer ASZ7.5/1000 Voltage Current rating	0...1000 ± 5% DC 10 V <4 mA
	Auxiliary switch ASC10.51 Switching capacity	AC 24...230 V, 6 A res., 3 A ind.

¹⁾ Observe acting direction of DIL switches

²⁾ AWG = American wire gauge

³⁾ Also with weather shield ASK39.1

⁴⁾ Transformer 160 VA (e.g. Siemens 4AM 3842-4TN00-0EA0) for actuators operating on AC 24 V

Connection Diagrams

Internal Diagrams

SAL31..

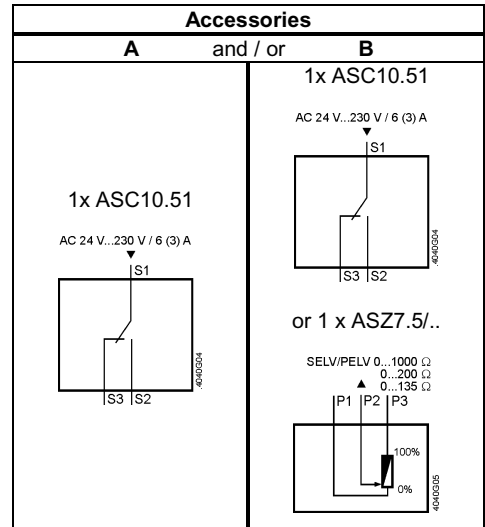
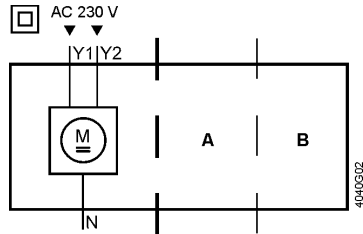

SAL61..

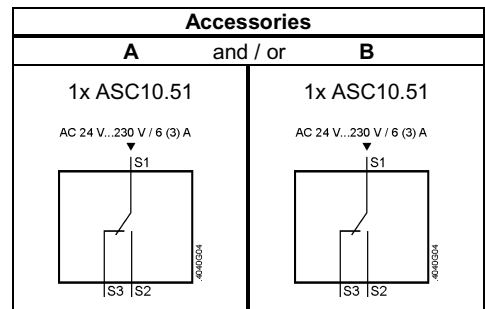
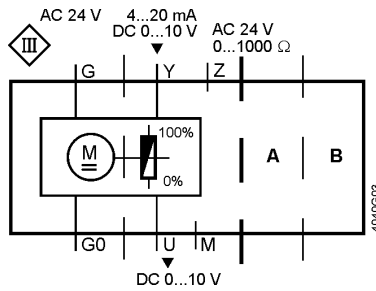

SAL81..

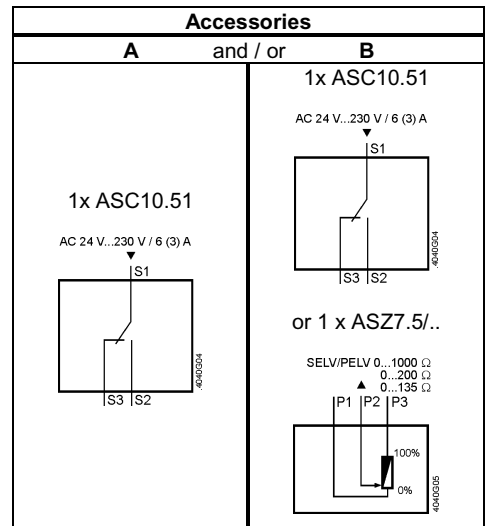
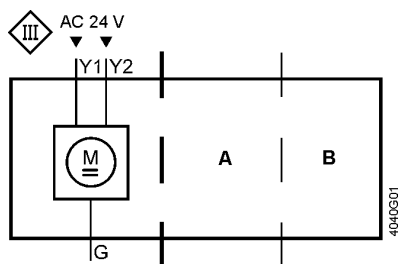

Connection terminals

SAL31..

AC 230 V, 3-position

- N** — System neutral (SN)
- Y1** — Positioning signal (actuator's spindle turns clockwise)
- Y2** — Positioning signal (actuator's spindle turns counter-clockwise)

SAL61..

AC/DC 24 V, DC 0...10 V / 4...20 mA / 0...1000

- G0** System neutral (SN)
- G** System potential (SP)
- Y** Positioning signal for DC 0...10 V / 4...20 mA
- M** Measuring neutral
- U** Position feedback DC 0...10 V
- Z** Positioning signal forced control AC/DC 24 V, 0...1000

SAL81..

AC/DC 24 V, 3-position

- G** System potential (SP)
- Y1** Positioning signal (actuator's spindle turns clockwise)
- Y2** Positioning signal (actuator's spindle turns counter-clockwise)

Connection terminals accessories

Auxiliary switch
ASC10.51

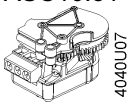

Adjustable switching points, AC 24...230 V

- 1** System potential (SP)
- 2** Closing (actuator's spindle turns clockwise)
- 3** Opening (actuator's spindle turns clockwise)

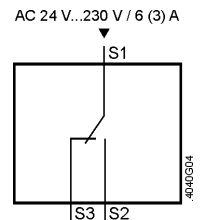

Potentiometer
ASZ7.5/..

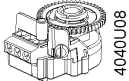

Adjustment of zero point, DC 10 V

- 1** Measuring neutral
 - 2** 0...x
 - 3** x...0
- x = 135 , 200 ;1000

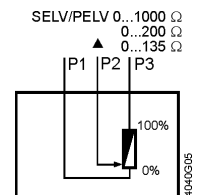

Connection Diagrams
SAL31..

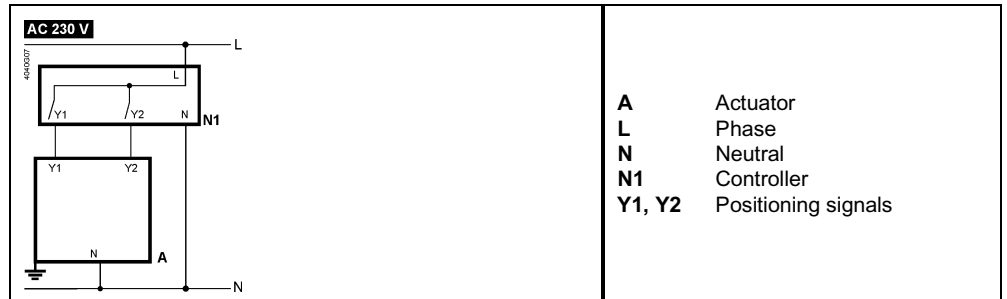

SAL61..

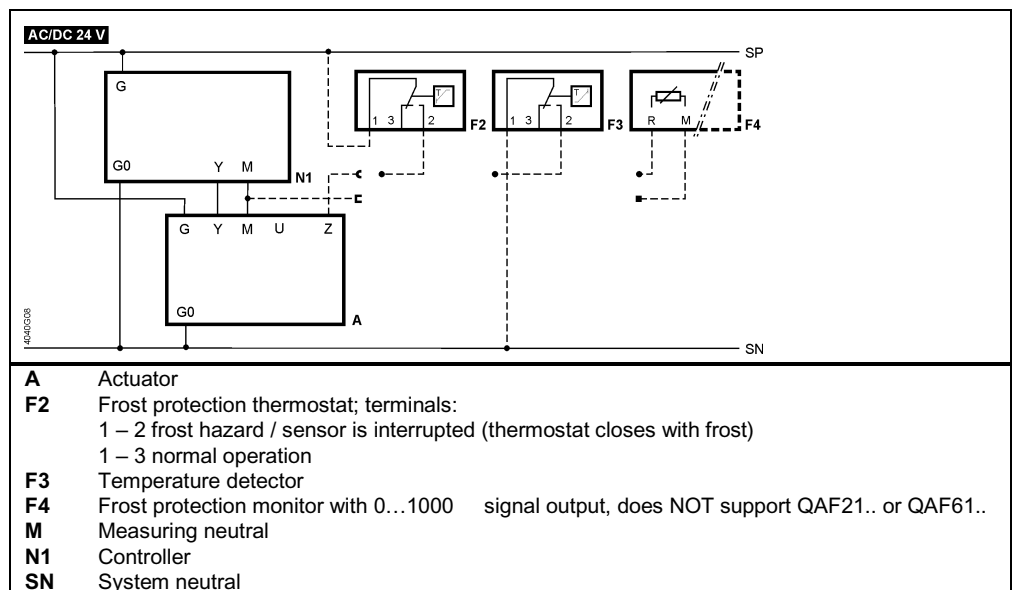

SP	System potential AC/DC 24 V
U	Position feedback
Y	Position signal
Z	Positioning signal forced control

SAL81..

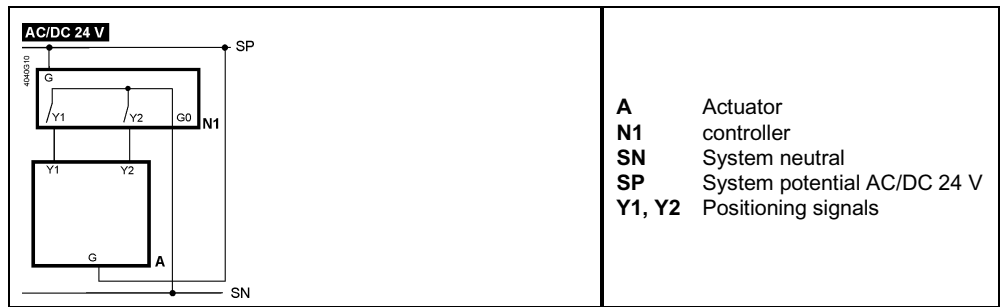

Dimensions

Dimensions in mm

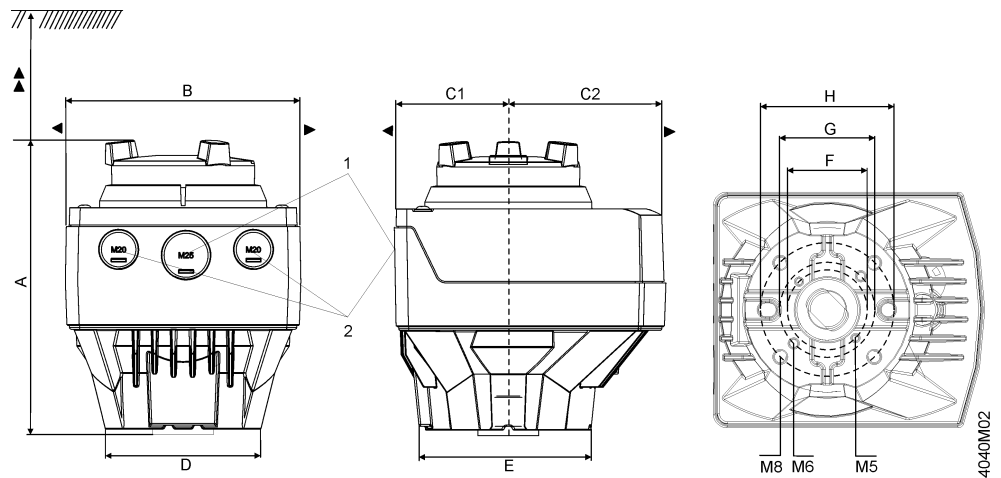

- 1 SAL...: M25
- 2 SAL...: M20

Type	A	B	C	C1	C2	D	E	F	G	H		
SAL..	160	124	150	68	82	82	88	42	50	70	100	200
With ASK39.1	+25	154	300	200	100	-	-	-	-	-	-	-

With mounting set ASK3..N

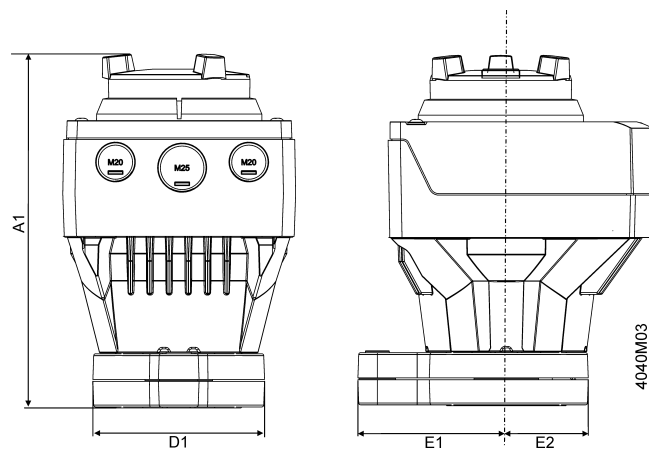

Type	A1	D1	E1	E2
SAL.. with ASK3..N	188	88	80	44
With ASK39.1	+25	-	-	-

Revision numbers

Product no.	Valid from rev. no.
SAL31.00T10	..A
SAL31.00T20	..A
SAL31.03T10	..A
SAL61.00T10	..A
SAL61.00T20	..A
SAL61.03T10	..A
SAL81.00T10	..A
SAL81.00T20	..A
SAL81.03T10	..A

