

The Siemens logo is displayed in a bold, teal, sans-serif font within a white rectangular box. The background of the entire page is a dark blue grid with glowing light blue lines and binary code (0s and 1s) scattered throughout.

Ingenuity for life

A large, industrial-grade drive cabinet is shown from a three-quarter perspective. The cabinet is light grey with multiple black ventilation grilles on its front and top. The interior components, including circuit boards and wiring, are visible through the open doors. The cabinet is set against a blue background with a grid pattern and glowing light effects.

SINAMICS PERFECT HARMONY GH180

Medium Voltage Drives

[siemens.com/sinamics-perfect-harmony-GH180](https://www.siemens.com/sinamics-perfect-harmony-GH180)

Catalog
D 17





Global
Edition
2019



Contents

SINAMICS Medium Voltage Drives	3
Overview	4
The Siemens Difference	5
Medium Voltage Drives: Performance and Experience	6
SINAMICS PERFECT HARMONY GH180 Air and Water-Cooled Drives	7
SINAMICS PERFECT HARMONY GH180 Benefits	8
SINAMICS PERFECT HARMONY GH180 Design	10
PERFECT HARMONY GH180 Cell Bypass Evolution	12
SINAMICS PERFECT HARMONY GH180 Solutions	13
PERFECT HARMONY GH180 Option Description	25
Selection and Ordering Data Explanation	42
SINAMICS PERFECT HARMONY GH180 Technical Data	44
General Technical Data	44
Storage, Transportation and Operation Data	46
SINAMICS Perfect Harmony GH180 Control Performance	47
SINAMICS Perfect Harmony GH180 Air-Cooled Technical Data	50
SINAMICS Perfect Harmony GH180 Water-cooled Technical Data	56
Water-cooled Drive Dimension Drawings	59
Air-cooled Drive Cooling Requirements	60
Water-cooled Cooling System Requirement	61
Siemens Industry Services	63
Scope of Supply	66
Recommended List of Spare Parts	66
Options Availability By Manufacturing Location	67

SINAMICS Medium Voltage Drives

One single topology or drive configuration does not fit all applications. This is the reason we offer converters and inverters featuring six different technologies, motor voltage classes from 2.3 kV to 13.8 kV and power ratings from 150 kW to 85 MW. Plus, our drive systems match perfectly with our high-voltage motors to provide you with unparalleled levels of reliability, availability, flexibility and performance.

	SINAMICS PERFECT HARMONY GH180	SINAMICS PERFECT HARMONY GH150	SINAMICS GM150	SINAMICS GL150
Technical Specifications				
Type of converter	Multi-cell voltage source inverter featuring H-Bridge Perfect Harmony technology (H-Bridge VSI)	Multi-cell voltage source inverter featuring Modular multilevel converter technology (M2C VSI)	3-level Neutral Point Clamped voltage source inverter with Diode Front End (3L NPC DFE)	Current Source inverter with load-commutated inverter technology (LCI)
Converter cooling	Air (A), water (W)	Air (A), water (W)	Air (A), water (W)	Air (A), water (W)
Power range	A: 0.14 to 8.2 MVA W: 3.5 to 48.8 MVA	A: 4 to 70 MVA W: 4 to 47 MVA	A: 1-10.1 MVA W: 2-24 MVA	A: 1-30 MVA W: 6-85 MVA (higher on request)
Transformer	Integrated transformer	Separate transformer	Separate transformer	Separate transformer
Rectifier section	A: 2Q (DFE); 4Q W: 2Q (DFE)	2Q (DFE)	2Q (DFE)	4Q
Output voltage	A: 2.3 to 11 kV W: 2.3 to 11 kV	A: 4 to 13.8 kV W: 4 to 11 kV	2.3 to 4.16 kV 6.6 kV (tandem)	1.4 to 10.3 kV

	SINAMICS SH150	SINAMICS SM150	SINAMICS SL150
Technical Specifications			
Type of converter	Multi-cell voltage source inverter featuring Modular multilevel converter technology (M2C VSI) with Active Front End (AFE)	3-level Neutral Point Clamped voltage source inverter with Active Front End (3L NPC AFE)	Cycloconverter (CC)
Converter cooling	Water (W)	Air (A), water (W)	Air (A), water (W)
Power range	W: 3-16 MVA	A: 3.4-5.8 MVA W: 4.6-31.5 MVA	A: 3-18.8 MVA W: 3-40 MVA
Transformer	Separate transformer	Separate transformer	Separate transformer
Rectifier section	2Q (DFE) or 4Q (AFE)	2Q (DFE) or 4Q (AFE)	4Q
Output voltage	3.3 to 7.2 kV	IGBT: 3.3 to 4.16 kV IGCT: 3.3 kV	A: up to 3.3 kV W: up to 4.0 kV

Overview

Siemens has more than four decades of experience manufacturing nearly every type of medium-voltage converter or inverter that exists today. We have chosen our portfolio of drives to meet your specific needs with the optimal solution for every type of medium-voltage application:

- Standard applications such as pumps, fans, compressors and conveyors
- Specialized applications such as rolling mills, horizontal mills, shaft generators and high-speed compressors

	SINAMICS PERFECT HARMONY GH180	SINAMICS PERFECT HARMONY GH150	SINAMICS GM150	SINAMICS GL150	SINAMICS SH150	SINAMICS SM150	SINAMICS SL150
Pumps	X	X	X	X			
Fans	X	X	X	X			
Compressors	X	X	X	X			
Boiler feed pumps	X	X	X	X			
Blast furnace blowers	X	X	X	X			
Conveyors (downhill)	X					X	X
Conveyors (uphill)	X	X	X				X
Crushers	X		X				
Extruders	X		X	X			
Mixers	X		X				
Kilns	X						
Electrical Submersible Pump	X						
High-pressure grinders	X		X				
Vertical mills	X		X				
Horizontal mills (geared)	X		X			X	X
LNG start / helper	X	X		X			
Test stands	X	X		X	X	X	
Wind Tunnel	X			X	X		
Rolling mills						X	X
Pump storage				X			
Static VAR compensation					X		
Horizontal mills (gearless)							X
Wire rod mill				X			
Mine winders						X	X
Generators				X	X		
Onshore power supply					X		
Excavators							X
Propulsion		X	X	X			
Thrusters			X	X			
Shaft generators				X	X		
Shaft booster				X			

The Siemens Difference

Siemens accompanies its customers every step of the way, through all phases of the project. Siemens experts provide their project management expertise with regard to safety, excellence and quality. To ensure consistent approach, medium voltage producing factories adopted Integrated Management System that is designed to assure that all quality, environmental, health and safety requirements are identified, documented, and followed.

Safety

Siemens Zero Harm Culture is a foundation of our operation from our customers who visit our location to employees and contractors. Siemens manufacturing locations implemented an Environmental Health and Safety Management Plan. Siemens plants responsible for MV Drives are certified according to the international standard for "Environmental Management Systems" (EMS, ISO 14001:2015) and "Occupational Health and Safety Management Systems – Requirements" (OHSAS 18001).



We are committed to developing and maintaining a premier health and safety culture for all parties associated with our operations. The provision of superior health and safety is a core value of equal importance to environmental protection, operational efficiency, customer service, and profitability. Safety will not be compromised in the course of meeting business objectives.

"Safety and compliance are the foundation of our business and non-negotiable."



Quality

Siemens Quality Vision is based on the following fundamental principles:

- Understanding and exceeding customer expectations
- Integrated into products and processes at an early stage
- Measured and transparent
- Continuous improve and
- Embraced by all employees.

Customer satisfaction is our priority in each and every respect. We provide quality for everything we do from building Zero Defect products, documentation and adherence to delivery dates to efficient commissioning and operational staff training. Siemens is certified according to international quality management standards (ISO 9001:2015) and is fully committed to delivering the utmost quality throughout our organization.



Excellence

For Siemens, excellence means outstanding customer experience through complete project and product life cycle - from the very first time a customer meets their Siemens representative to product performance, commissioning and service. Siemens examines each company's unique situation, identifies all potential opportunities, and helps select the best solution. As a global player, we support and ensure that competent local support is provided from the first consultation to the after-sales service.

Medium Voltage Drives: Performance and Experience

Always the Right Solution

There's no such thing as a one-size-fits-all variable frequency drive (VFD). That's why the SINAMICS family of drives draws on the Siemens legacy of innovation to deliver reliable, high-quality power for a wide range of applications. Designed to save energy, reduce operating costs and reinforce reliability, SINAMICS VFDs are the industry's preferred choice in power conversion:

- Wide range of input voltage capability from 480V to 34.5kV
- A seamless range of power ratings from 100kW to 85MW
- Single-motor drives and multi-motor systems
- Oldest Motor Retrofitted – 1942 (68 years old at time of retrofitting)
- Motor speeds from 7 to 15,900 rpm
- Operates Induction, Wound Rotor, Synchronous, Permanent Magnet and Super-conducting Motors

Strong Foundation

For decades, Siemens has offered our customers medium voltage drives with the highest degree of reliability and availability in the world.

The reliability of our drives has become legendary. Years of experience, power of innovation and comprehensive knowledge has enabled Siemens to become the trusted name in the medium voltage drive arena. Over 45 years of research and development in the area of medium voltage drives:

- 1969: Develops Variable-speed medium voltage drive systems with current-source DC link
- 1970: Introduces Cycloconverter for low speed applications
- 1994: Revolutionizes medium voltage drives with cell-based topology of ROBICON Perfect Harmony
- 1995: Launches SIMOVERT ML for rolling mill applications
- 1998: Pioneered the use of high-voltage IGBTs for medium voltage drives
- 2003: Produces the highest-rated high-speed drive (LCI) for an LNG compressor (65 MW)
- 2013: Launches SINAMICS SM120 CM – first medium voltage drive featuring M2C technology
- 2014: Launches SINAMICS GH150 – general purpose medium voltage drive featuring M2C technology
- 2017: Reaches 15,000+ SINAMICS Perfect Harmony GH180 drives installed worldwide

Proven Technology

Based on well-proven technological concepts, Siemens is continually improving our medium voltage drives. The result: increasingly higher reliability and operational reliability and safety, more compact types of construction, reduced energy requirements, lower service and maintenance costs, as well as simpler handling from engineering through to installation, integration and commissioning up to operator control. With an installed base exceeding more than 25 GW worldwide, the SINAMICS Perfect Harmony GH180 is a proven workhorse that can perform brilliantly for you, too.

A Bright Future Built on a Firm Foundation

Since its introduction in 1994, the SINAMICS PERFECT HARMONY drive has revolutionized power conversion and continues to set industry standards for reliability and innovation. As power switching device technology advances and increases output voltage capability, Siemens improves each generation of the SINAMICS Perfect Harmony GH180 in three key areas: increased reliability and availability, increased efficiency, and a smaller drive footprint.

Advances to our product line are made without “reinventing the wheel” like other drive manufacturers. Siemens has maintained the SINAMICS PERFECT HARMONY's core topology and continues to advance its capability, ensuring life-cycle product support. By keeping the same topology, our customers see a reduction in maintenance and spare parts as well as an increase in quality and lower life-cycle costs. We improve our products by actively soliciting the input of our customers, and we look forward to counting you among them.

The SINAMICS Perfect Harmony GH180 of today represents an evolution founded on experience garnered from our large installed base coupled with Siemens' unparalleled investments in Research & Development. As one of the largest companies in the world, Siemens provides confidence and financial stability in addition to exceptional technology. We offer you expertise across the globe and a world of innovation.



SINAMICS PERFECT HARMONY GH180 Air and Water-Cooled Drives

Technical Characteristics

Air-Cooled Drives



Water-Cooled Drives



The SINAMICS Perfect Harmony GH180 drive family consists of core design configurations, where they are functionally identical and share a common controller. These designs are targeted at distinct output power configurations with little overlap between the frame sizes. The SINAMICS PERFECT HARMONY GH180 family is summarized in the tables below.

SINAMICS PERFECT HARMONY GH180 characteristics at a glance

Line-side rectifier		6SR5 6SR4 6SR327	24 to 54 pulse diode rectifier 24 to 54 pulse diode rectifier 18 to 48 pulse diode rectifier
Motor-side inverter			Multilevel drive (PWM)
Power cells	A	6SR5 6SR4 6SR327	40, 70, 100, 140, 200, 260, 340, 430 315, 375, 500, 660, 750 880, 1000, 1250, 1375
Input voltage range	kV	6SR5 6SR4 6SR327	480 V to 13.8 2.3 to 13.8 2.3 to 13.8
Input voltage tolerance			+10%, -10% ¹⁾ of nominal rated input voltage
Input overvoltage (swell)			+20%
Input undervoltage (dip or sag)			-34%, continues operation with reduced torque
Medium voltage ride through			500 msec (30 cycles @ 60 Hz and 25 cycles @ 50 Hz)
Input frequency	Hz		50/60 ± 5 %
Input power factor			≥ 0.95 above 10 % load
Input harmonics			≤ 3 % Total demand distortion (TDD) ²⁾
Output voltages	kV	6SR5 6SR4 6SR327	2.3/2.4, 3.3, 4.0/4.16, 4.6/4.8, 6.0, 6.6, 10.0, 11.0 2.3/2.4, 3.3, 4.0/4.16, 4.6/4.8, 6.0, 6.6, 6.9/7.2, 10.0, 11.0 2.3/2.4, 3.3, 4.0/4.16, 4.6/4.8, 6.0, 6.6, 6.9/7.2, 10.0, 11.0
Output frequency and drift	Hz		0.5 ... 330 ± 0.5 % (sensor-less or open loop vector control), or ± 0. 1% with encoder (encoder or closed loop vector control)
Output Torque			100% from 10 – 167 Hz ³⁾ without derating
Drive quadrants			2 or 4
Power range	Hp	6SR5 6SR4 6SR327	150 to 3500 (100 kW to 2.6 MW) 3500 to 9000 (2.6 to 6.7 MW) 4000 to 33000 (3 to 24.6 MW)
Overload	1min/ 10min	6SR5 6SR4 ⁴⁾ 6SR327 ⁴⁾	110% built-in, 150% available as an option, higher on request 110% built-in, 150% available as an option, higher on request 110% built-in, 150% available as an option, higher on request
Drive Control methods			Sensor-less or open loop vector control, encoder or closed loop vector control, volts-hertz control
Motor control			Induction, Synchronous, Permanent magnet motors, and Wound rotor motors

1) Below -5% current derate might be applied

2) As measured at the drive input, actual performance at the site will depend on the present harmonic distortion

3) Proper drive sizing is required, GH180 drives, when de-rated properly, are available for high frequency with de-rated torque.

4) GH180 drives with 750 A for 6SR4 and 1000 and 1375 A for 6SR327 are only available with 100% rated current.

SINAMICS PERFECT HARMONY GH180 Benefits

Clean Input Power

The SINAMICS Perfect Harmony GH180 drive:

- Meets the most stringent IEEE 519-2014 requirements for voltage and current harmonic distortion, even if the source capacity is no larger than the drive rating¹⁾:
 - The GH180 drive is supplied with a minimum 18-pulse input with versions available up to 54-pulse input, resulting in less than 3 percent total voltage distortion and less than 3 percent total current distortion. It eliminates the need for costly and inefficient harmonic filters and its associated resonance problems
- Protects other online equipment from harmonic interference (computers, telephones and other power converters)

Sinusoidal Output Power (Waveforms)

The SINAMICS Perfect Harmony GH180 drive:

- Minimizes drive induced torque pulsations and associated torsional analysis compared to other medium voltage topologies, by using a motor friendly pulse width modulation (PWM) output:
 - Less than 1% induced torque ripple for any given frequency results in no motor heating and no bearing wear
- Eliminates additional losses due to harmonics; thus, it can be used with new or existing motors without de-rating:
 - Depending on configuration generates 13 to 33 level output waveform line to line
 - Small output voltage steps produce no voltage spikes at the motor which allows the use of a motor with standard insulation
 - No need for filters up to 7500ft (2.3km)
 - Waveforms remain high quality at lower speeds due to multi-level PWM output



1) IEEE 519-2014 compliance can only be guaranteed in networks without prior disturbances or harmonics already present.

Maximized Availability

The SINAMICS Perfect Harmony GH180 drive:

- Remains operational in the event of a cell failure by using the cell bypass option which bypasses the faulted cell
- Achieves near 100 percent reliability and 99.99 percent availability, delivers greater productivity and a significantly reduced total cost of ownership over the drive's life cycle
- Offers a Process Tolerant Protection Strategy (ProToPS™). ProToPS™ protects customer process from faulty sensors or data. Unlike typical systems that simply trip the drive and shut down the system due to a malfunction, it offers a proactive control approach based on a hierarchical warning system that allows the operator to evaluate the drive and system condition and respond appropriately or initiate controlled shutdown.

Extended Reliability

The SINAMICS Perfect Harmony GH180 drive with an integrated transformer provides the following advantages:

- Protects drive semiconductors from line transients
- Completely protects the motor in case of a ground fault in the converter, the motor cabling or insulation

Exceptional Input Line Performance

Robust design provides immunity from most input power disturbances and interruptions to insure protection of customer equipment and trip free operation during most common and frequent power quality issues:

- Best in class input voltage brownout conditions - no trip down to 66 percent of nominal voltage. Output power is reduced by limiting the available motor torque, drive can operate continuously in this mode
- When voltage drop below 66 percent, it results in drive's ride through mode - power loss ride through up to 500 msec (30 cycles @ 60 Hz and 25 cycles @ 50 Hz systems)
- Built-in input transformer with lightning arrestors to provide protection from excessive peak voltage

Over 20 years of performance and more than 15,000 units in operation exceeding 25.5 million kW installed power worldwide, Siemens has only one goal in mind: optimizing customer profitability

Extensive Testing

You can be confident that the SINAMICS Perfect Harmony GH180 will get your process up and running because we have the ability to test every product at full load – prior to delivery:

- At our factory, we test every transformer and power converter together to ensure performance meets precise specifications.
- We verify sequence of operation and protection to ensure that the SINAMICS Perfect Harmony GH180 drive matches your needs.
- As an option, factory testing allows accurate efficiency measurements if customer requests it.

Ease of Installation and Maintenance

SINAMICS Perfect Harmony GH180 drives are easy to install and maintain:

- Customer provides three cables in and three cables out. There is no customer site cabling required to connect the drive sections.
- Power cells can be removed easily for maintenance due to their reduced weight and front accessible connections. Failed cells can be changed out later in 30 minutes or less.
- With optional Advanced Cell Bypass a faulty cell can be changed out at a later date in 30 minutes or less.
- Sophisticated microprocessor-based diagnostics pinpoint the location of any defects



*SINAMICS PERFECT HARMONY GH180 -
The Drive of Choice for High
Performance: reliable, precise, and
durable in the most demanding
applications.*

SINAMICS PERFECT HARMONY GH180 Design

Drive Topology

The SINAMICS Perfect Harmony GH180 series drives achieve an uncompromising performance by employing well-proven technology in a modular configuration, as shown in Figure 1. Medium voltage levels are obtained by adding together the outputs of multiple power cells. The power cells are simplified variations of standard 2-level PWM low voltage drives, which have been built in high volume for many years.

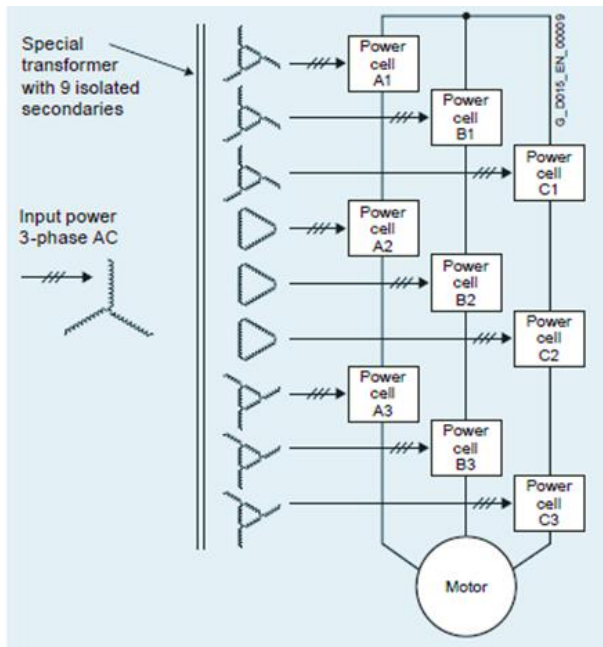

Figure 1: Topology of SINAMICS PERFECT HARMONY GH180 Drive (3 cells per phase)

For higher output voltage capabilities, the SINAMICS Perfect Harmony GH180 topology can be extended up to eight power cells in series in each phase, with additional secondary windings (number of secondaries equals number of power cells) on the integral isolation transformer.

Transformer

Since the early 1990s, Siemens has collaborated extensively with transformer suppliers to perfect the design of the transformers used in each SINAMICS Perfect Harmony GH180 drive. The patented design provides several benefits in the drive topology, including the adaptability to input voltage, a multi-pulse input, and a reduction in common mode voltage.

The transformers used in the SINAMICS Perfect Harmony GH180 are VPI dry-type, forced-air or water-cooled. They are designed specifically for use with a particular SINAMICS Perfect Harmony GH180 drive configuration and have 9 to 24 extended delta secondaries.

The SINAMICS PERFECT HARMONY GH180 transformers are designed, constructed, and tested as per IEC 60076-11 standard. The transformer is an integral part of the drive that cannot be specified or obtained externally to Siemens.

Proven IGBTs

Low voltage Insulated Gate Bipolar Transistors (IGBTs) form the backbone of the SINAMICS Perfect Harmony GH180 drive. Built in high volumes and serving as a proven power device across the industrial power control industry, IGBT technology has been in existence for more than two decades. The stability and availability of IGBTs give reliable, long-term, lifecycle confidence.

Linked Power Cells

In the SINAMICS Perfect Harmony GH180, a series of power cells (see Figure 2) are linked together to build the medium voltage power output of the drive system. This modular configuration gives the SINAMICS Perfect Harmony GH180 many advantages when it comes to maintenance, power quality and reliability. It also provides the basis for one of its most important advantages – increased availability through the advanced cell bypass option.

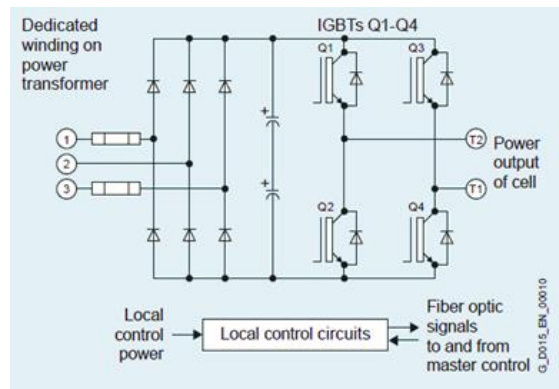

Figure 2: Schematic of a typical power cell

Advanced Cell Bypass

The SINAMICS Perfect Harmony GH180 is designed to withstand failures that would overwhelm conventional drives because redundancy options are added into the system. The patented, cell-based configuration maximizes uptime and simplifies modifications.

Through a redundant bypass control that is completely separated from each power cell, SINAMICS Perfect Harmony GH180 ensures automatic bypass of a failed power cell in 250 ms. The mechanical cell bypass option is implemented by providing a contactor at the output of each cell. One of the many benefits of mechanical cell bypass includes the ability to be tested during customer factory acceptances testing.

Since the cells in each phase are in series, bypassing a cell has no effect on the current capability of the drive, but the voltage capability will be reduced. Usually the required motor voltage is roughly proportional to speed, so that the maximum speed at which the drive can fulfill the application requirements may also be reduced.

It is important to maximize the motor voltage available after one or more cells have been bypassed. The following figures illustrate the voltage available from a SINAMICS Perfect Harmony GH180 drive, where the cells, represented by circles, are shown as simple voltage sources. Figure 3 shows a 15-cell drive in which no cells are bypassed. With 100% of the cells in use, 100% of the original voltage is available. The voltage commands to the three phase groups of cells will have phase A displaced from phase B by 120°, and from phase C by 120°.

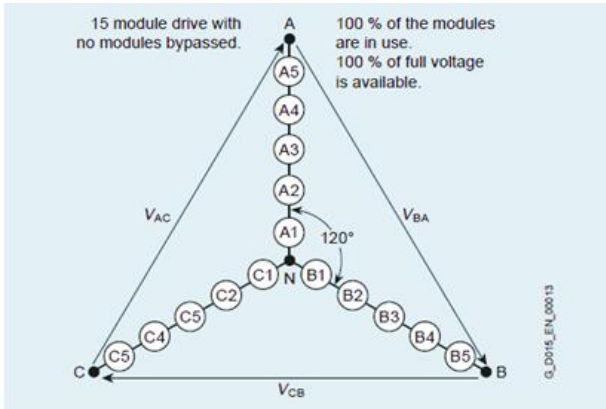

Figure 3: Simplified diagram of a 15 cell drive

When two cells are bypassed in phase A, the output voltage will tend to become unbalanced, as illustrated in Figure 4 and not suitable for operating a motor.

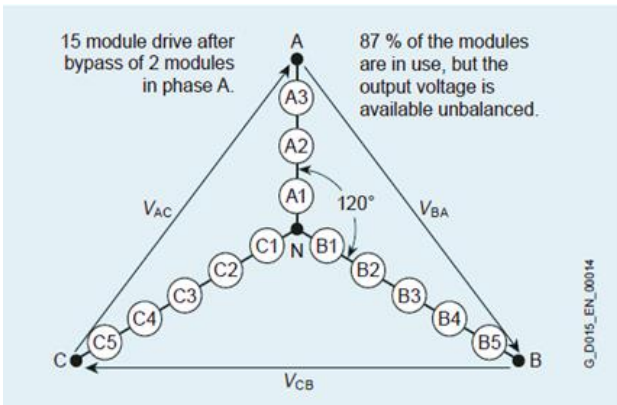

Figure 4: Drive output with 2 cells bypassed in phase A

One possible remedy is to bypass an equal number of cells in all three phases, even though some may not have faulted. Figure 5 illustrates this approach.

Obviously, this method prevents unbalance but sacrifices possible voltage capability. In this figure, 87% of the cells are functional, but only 60% are in use, and only 60% of full voltage is available.

A better approach is illustrated in figure 6. This method takes advantage of the fact that the star-point of the cells ground is floating and is not connected to the ground. Therefore, the star-point can be shifted away from the motor neutral, and the phase angles of the cell voltages can be adjusted, so that a balanced set of motor voltages is obtained even though the cell group voltages are not balanced. Siemens calls this approach Neutral Shift¹⁾.

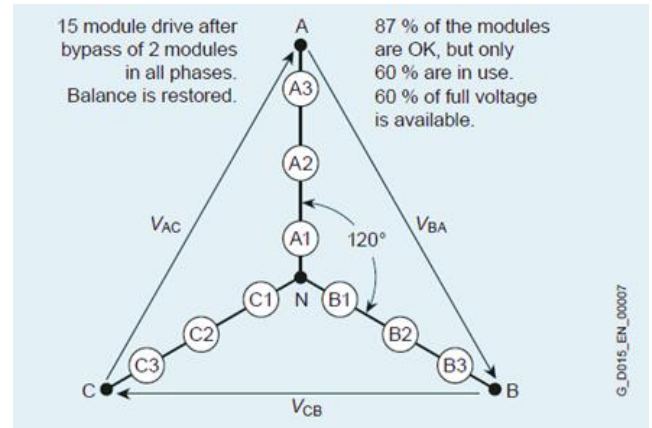

Figure 5: Drive output rebalanced by bypassing functional cells

In figure 6, the full remaining 87% of functional cells are in use, and 80% of the original voltage is available. The phase angles of the cell voltages have been adjusted so that phase A is displaced from phase B and from phase C by 132.5°, instead of the normal 120°.

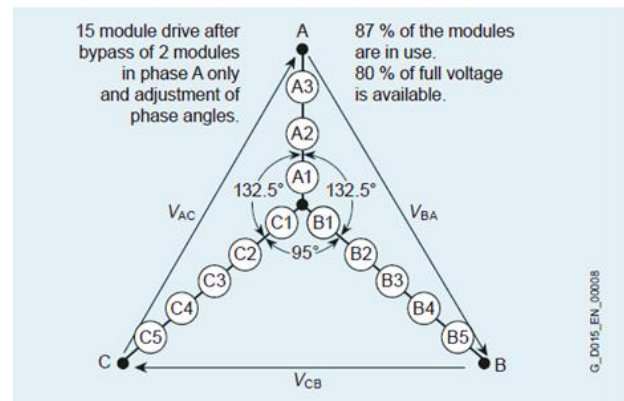
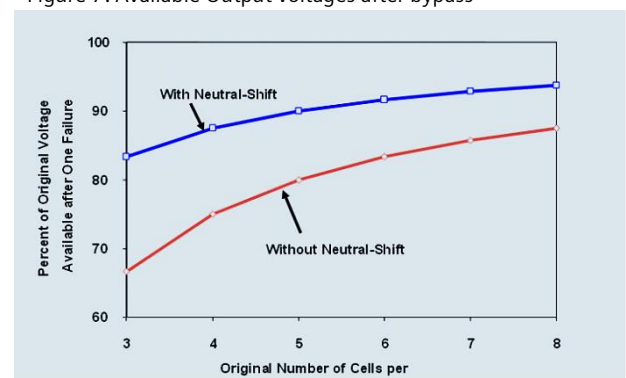

Figure 6: Drive output rebalanced by adjusting phase angles (Neutral Shift)

The figure 7 below demonstrates the available output voltage after one cell is bypassed based on number of cells in configuration and bypass method used. SINAMICS Perfect Harmony GH180 with neutral point shift is capable to provide 83% of output voltage compared to below 70% for the drive with the same number of cell but without neutral point shift capability.

Figure 7: Available Output voltages after bypass



1) Siemens patented technology; Patent number 5,986,909

PERFECT HARMONY GH180 Cell Bypass Evolution

The SINAMICS Perfect Harmony GH180 has revolutionized medium voltage power conversion. Perfect Harmony multilevel topology was invented by Robicon (now Siemens) in 1994. Siemens continues to be the technology leader for multilevel topology inverters and has over 50 unique patents and 100 international patents filed around Perfect Harmony topology. In 2017 Siemens released its 5th generation of SINAMICS Perfect Harmony GH180.

The SINAMICS Perfect Harmony GH180 drive continues to set industry standards for reliability and innovation. Siemens improves each generation in three key areas: increased reliability and availability, increased efficiency, and a smaller drive footprint. The innovation includes further improving cell bypass technology: evolving from an electronic thyristor based bypass (SCR) integrated to each cell to a mechanical bypass totally independent of the cell.

Cell Bypass Evolution

In the original concept as implemented 25 years ago, each cell contained a single phase rectifier bridge with a thyristor. The AC inputs of this rectifier bridge were connected to the cell output terminals. In the event of the failure bypass SCR is shorted effectively disconnecting the cell from the input power. Although this approach was effective under certain failure conditions, it had several drawbacks:

- Since cell and bypass share fiber optic communication, if it is lost, then the bypass can not be engaged because the control can not activate cell bypass due to the failed communications. Therefore, this bypass system is less effective and less reliable.
- If there is any component failure in the cell such as IGBT, gate drive, cell control board power supply that may lead to bypass control malfunction resulting in the loss of the bypass functionality.
- To protect cell from exposure to fault current bypass circuitry had built-in fuse, that would automatically blow when cell bypass is engaged. If it was a nuisance trip customer could not automatically reset it which required a new cell for replacement.

In 2000, to overcome these difficulties, bypass was changed to an external mechanical contactor supplied from a completely independent power source and controlled by a separate control means. This contactor does not have to interrupt current, so it doesn't need arc control measures. The contactor is a single pole double throw arrangement so that it can disconnect the cell from the output string and apply a shorted contact in place of the cell. With this bypass, the cells do not have to function at all for bypass to work.

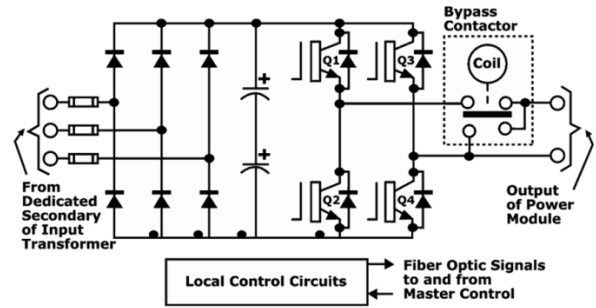

Advantages of the mechanical cell bypass

- The SINAMICS Perfect Harmony GH180 bypass is based on traction DC contactor – proven and trusted technology!
- It does not matter which of the components has failed within the cell. In fact, even a failure in the fiber optic link that communicates to the cell can be detected and bypassed. This approach protects against the failure of any component in the power circuits or in the communications circuits, rather than protecting the drive against power semiconductor failure only.
- Mechanical bypass has separate communication with the drive control and independent regulated power supply to ensure maximum availability.
- In the instance of a nuisance trip customer can automatically reset bypass and continue the operation.
- During the fault, drive control performs a quick check to verify if the motor output voltage can be supported by the functional cells before a cell is bypassed. This voltage can be near the drive rated output voltage for a few seconds before dropping over time. If a cell is bypassed too fast, the remaining cells may not be able to support this voltage and leading to cells malfunction. SINAMICS Perfect Harmony GH180 has built-in control function to perform all necessary checks to ensure safe and reliable operation.
- When cell is bypassed, it allows for process ride through with an interruption of only 250 ms or less.

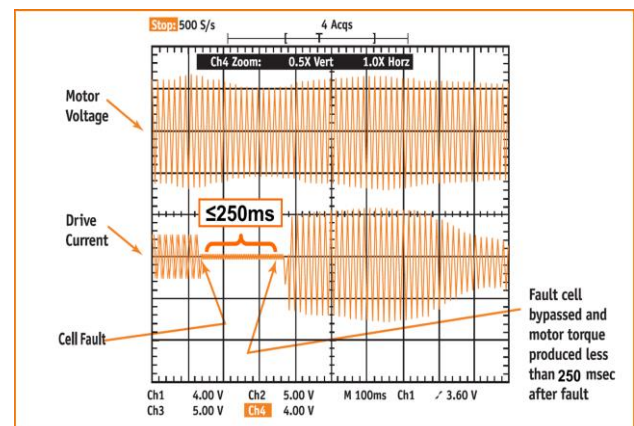

SINAMICS PERFECT HARMONY GH180 Solutions

Drive Heat Load Management

During operation, every drive generates heat that needs to be removed from the room to avoid equipment overheating. In many installations, it is very common to use air-conditioning to reduce the heat in the control room. The amount of heat dissipated into the room depends on the drive cooling method, efficiency, drive size and other equipment located in the same space.

The more heat rejected into the room the higher operational cost and total costs of ownership of the drive are. The drive typical losses are 3.0-3.5% of the drive rating (depending on drive efficiency). Air-cooled drives usually dissipate heat directly into the room and require additional measures to keep operating within the manufacturer specified range; while water-cooled drives reject most of the losses into the water, less than 5% of losses are rejected into the room.

The difference in cooling requirements for installations where heat rejected directly into the room could be 20 times higher compared to solution where losses are ducted outside the room. For example, 4000Hp drive losses in the room are 96kW requiring 27 ton of air conditioning while the same drive with ducted air outside or Heat Exchanger (Air-to-Air or Air-to-Water), has only 4.8 kW losses requiring only 1.4 ton of air cooling. In this case heat losses in the room are similar to water-cooled drive performance. In order to reduce the requirement for air-conditioning of a control room, it is worth evaluating various heat management options available for air-cooled drives:

- The air can be ducted directly outside (options M64 or M68)
- Air-to-Air Heat Exchanger (option W41)
- Air-to-Water Heat Exchanger

Each approach has its own advantages and limitations and each case should be evaluated based on customer application, site conditions, availability of water, etc. Below are highlights of each option.

Ducting hot air outside is one of the most economical implementations but it does require upfront engineering from a customer. Engineering is required to design proper air flow in the room to avoid creating a vacuum or wind tunnel effect in the room. The air can be drawn either from outside with proper filtration to meet drive installation requirements or in some cases, HVAC is capable of supporting the necessary airflow. It is critical to design the solution properly to prevent unnecessary trips due to lack of air. The regular maintenance of outside filters is required to ensure that no contaminants get into the drive.

In close loop systems air is drawn through ventilation openings at the bottom or the front of the drive, depending on the product line, then circulated through the transformer and power cell sections and exhausted through the back of the drive enclosure. The hot and cooled air is transferred to the heat exchanger by duct work through the control room or power distribution center exterior wall. Warm air is cooled

via the heat exchanger and circulated back to the drive. Heat exchanger units are rated for ambient temperatures from 32° F to 104° F (0° C to 40° C). When required, they can be equipped with options to meet -40° F (-40° C) including space heaters, louvers and snow hoods for cold environments.

The Air-to-Air Heat Exchanger is a self-contained solution that does not require additional engineering on the customer's behalf. Every heat exchanger has built-in fan redundancy and comes complete with heat exchanger controls. Compared to open loop systems, this solution provides higher degree of contamination protection due to the two separate airflow design, which keeps dirt, moisture, and other elements from getting into the equipment. In addition, every system is factory tested as a unit (drive and heat exchanger) to ensure operation as designed and specified.

Heat Exchangers require higher initial investment compared to open loop system or HVAC solution, it typically has the lowest total cost of ownership compared to traditional HVAC and a pay back of 2-3 years depending on size of the drive.



Figure 8 Installation with Air-to-Air Heat Exchangers and two drives in the building

Air-to-Water Heat exchangers provide similar benefits as Air-to-Air Heat Exchangers and is a good fit for installations where water is available on site. Heat is removed from the hot air and transferred to the customers' water system. There are two possible ways to implement this configuration the first one is similar to Air-to-Air Heat Exchanger set up where heat exchanger itself located outside and the hot air from the drive ducted. The second one is when the VFD blower cage assembly is replaced with the Heat Exchanger assembly. This solution does not require ducting work done to the building thus reducing additional engineering effort.

The Air-to-Air Heat Exchanger is about 5 to 10% more reliable compared to industrial redundant HVAC systems and about 20 to 30% more reliable compared to commercial HVAC systems. This reliability improvement is due to fewer components in the Heat Exchanger compared to HVAC system which consists of compressors, fans, belts, valves, etc. The above figures are based on the data collected by our field support team over past 10 years.

Advanced Motor Protection – a true variable speed performance

SINAMICS Perfect Harmony GH180 is the only medium voltage drive that offers a patented solution (patent pending) for motor protection at variable speed operations. The drive protection uses integral closed-loop hall effect current sensors and output attenuators to obtain accurate motor data.

This option offers additional features and allows customers to set pickup and trip levels at various points across the speed curve (for detailed feature list see option description). Some of the features included in this option (for extended list see option description):

- Undercurrent (37)
- Underspeed (14)
- Current Unbalance, Negative Sequence (46_2)
- Machine Thermal Overload RTD (49 RTD)
- Differential protection equivalent (87M)

Most functions offered within the option can be enabled to start monitoring and protecting the motor along the speed curve: the operator can set protection at any point that is critical for their application and process including time delays. No other solution available today on the market offers this flexibility and capability. The standard motor protection available with most VFDs only allows fixed default settings.

The graph below serves as an example and shows flexibility to set up process defined curves. The gray color is normal operating conditions, the yellow color represents the alarm setting area and the orange color represents the fault setting area. Many of the protection curves have a latched minimum speed enable at which point protection settings do not apply. The thermal protection function offer either an alarm or trip setting. All other functions provide an alarm or fault setting.

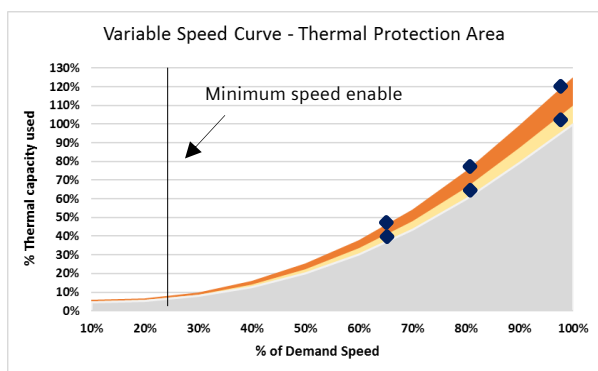

The big difference between standard protection and an advanced one is enhanced thermal motor protection (ANSI 49T). The algorithm is designed to meet the requirements of IEC 60255-149 standard. This is the only function that offers both an alarm setting and the trip setting to give customers advanced warning before the process and the motor are taken off line. The Advanced Motor Protection Option has a patented thermal model to provide locked

rotor and running overload protection. It includes the following elements:

- Motor thermal capacity
- Biasing based on both measured stator and ambient temperatures (optional)
- Measure of negative sequence current
- Average RMS phase currents
- Motor Run and Stop status

RTD biasing is used as a backup protection to account for such things as loss of cooling or unusually high ambient temperature. This measured temperature is used to modify the thermal capacity value. Thermal overload pickup is set to the maximum allowed by the service factor of the motor. It is typically about 10% above motor service factor. If RTD biasing is enabled, it can be higher since it provides a more accurate temperature feedback.

The graph below shows setpoints for traditional RTD bias. In this instance, the motor has F class insulation which is rated at 155°C, the stator temperature rise is 85°C with SF@1.0 and ambient temperature of 40°C. The motor overload curves or hot-to-cold starts ration are used to determine motor thermal capacity for the mid-point.

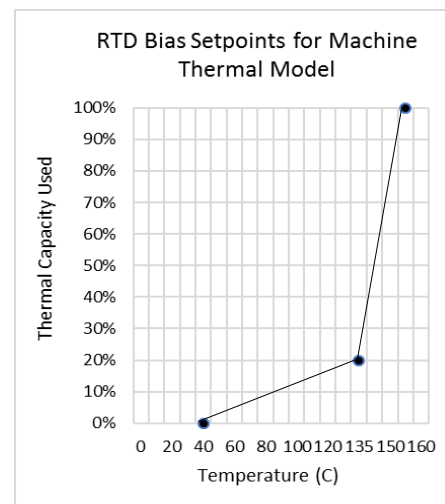

Setpoints for traditional RTD bias example

This option includes the SIMATIC S7, SM 1231 AI thermocouple 12 channel RTD unit. The option is compatible with the following three-wire RTD types:

- Pt10, Pt50, Pt100, Pt200, Pt500, Pt1000,
- Ni100, Ni120, Ni200, Ni500, Ni1000,
- Cu10, Cu50, Cu100, LG-Ni1000.
- Pt100 is a default setting and others are available on request.

RTDs monitoring functionality is integrated into NXG control and each individual sensor can be monitored by customer through their DCS or plant HMI. All faults or alarms are stored and can be viewed through the drive event log.

Bidirectional Synchronous Transfer

There are two primary applications that require synchronous transfer:

- The first one is a drive used as a soft-starter to reduce stress from starting motors directly on line
- The second one is used for process/flow control: starting up multiple motors and synchronizing them to the line according to customer specifications.

The key difference between these applications is sizing of the drive. When variable frequency drive (VFD) is used to start the motor in an unloaded condition, the VFD does not have to match the full rating of the motor. For example, a 20,000HP motor may be started by a 5000HP VFD if the drive output can provide sufficient output current and develop enough motor torque to accelerate the motor up to full speed. In this instance, the VFD is at full power only for a very short period of time. The drive transfers a motor across the line after the motor is at full speed. In all cases the motor is started in either unloaded or partially loaded condition.

The drive is often used in this application when incoming line is soft and cannot support the inrush current of the motor during starting. Sometimes, the incoming line is even too weak to support a reduced-voltage start even though inrush current is less it is still about 250% to 300% of the motor full load current rating. Starting motors with VFDs have the following benefits:

- Multiple starts per day
- Draws minimal inrush currents while starting, minimizing voltage drop and system electrical stress
- Reduces mechanical shock (starting torque is controlled at nominal levels)

For such applications the SINAMICS Perfect Harmony GH180 has a function for single motor synchronous transfer option (L29) that does not require any PLC, it is done by the drive's control and in most cases without need for an output reactor.

For the second option, the drive is sized to run the motor full time. In a pumping station, the demand can change significantly within a day for the water and wastewater industry and seasonally for oil pipelines. One variable frequency drive can be used in combination with multiple motors to adjust the flow to meet the demand. In this case, the last pump is always run by VFD for flow and pressure control.

Siemens can design your sync transfer system to suit your application. With standard, pre-configured systems that utilize our best-in-class VFD and motor control products, Siemens can provide a full spectrum of standard and flexible options.

Once the sync transfer system has been completely assembled, Siemens performs full power testing to ensure seamless integration and operation. Components are assembled and tested. The Sync Transfer Control System (STC) supports transfer of two to eight motors directly to or from a line source of power. The system is designed to

handle induction motors or synchronous motors and connection of motors to a source the same as the drive or to an alternate source.



Figure 9: Switchgear and Reactor Lineup for 3 motor Synchronous Transfer Application

Optimized Synchronous Transfer

The traditional synchronous transfer option uses output reactor for a bump-less closed transfer (figure 10). Connecting voltage source VFDs to a motor in parallel to the line (closed transfer) can result in excessive currents. The solution used to prevent such excessive currents has always been to add a reactor between the VFD output and the motor.

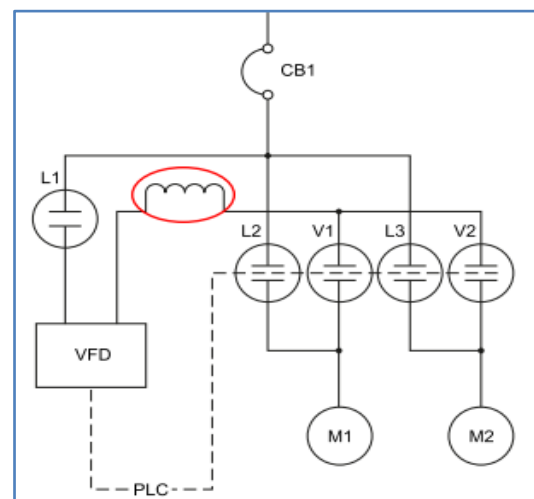

Figure 10: Typical multi-motor synchronous transfer application with reactor

The advantage of this implementation is the ability to operate for periods of time in parallel with the line. This makes the transfer from the line to the VFD as smooth as possible. The limitation of this solution is higher initial capital cost, increase of the losses within the drive system and reduced output voltage capability of the drive system. While the losses and voltage drop are negligible with regards to motor operation, the reactor losses require additional cooling. The cooling of these losses is either can be done by placing the reactor outside or increasing the AC capability of the cooling system. Regardless, the capital cost of including a reactor is significant.

Due to increases in drive control processing power synchronous transfer can be optimized to eliminate the use of an output reactor. This optimized synchronous transfer can be applied to most motor drive applications.

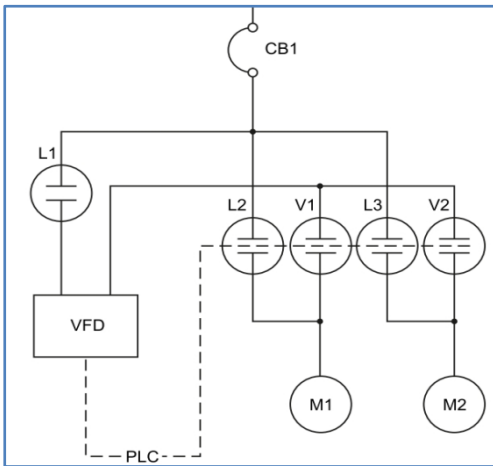

Figure 11: Optimized multi-motor synchronous transfer

The benefit of this approach is the ability to remove the reactor between the VFD and the motor, and the associated motor line contactor feedback to the SINAMICS Perfect Harmony GH180 VFD. Synchronous transfer of the motor to the line remains as a closed bump-less transfer.

The optimized synchronous transfer does differ during “down” transfer. When the motor is transferred from the line back to VFD while it is still closed transfer, it will result in a step torque change to the motor but it has minimal impact on process. The magnitude of this step change is limited to the allowable torque.

Optimized Synchronous Transfer of Motor to Line (Up Transfer)

Optimized synchronous transfer operates in the same manner as the traditional GH180 transfer operation with regards to “up” transfer so the same operational logic and application methods apply. The graph below shows the motor operation during an “up” transfer:

- The magenta waveform is the voltage magnitude as seen by the motor.
- The blue waveform is the output voltage of the VFD.
- The green waveform is motor current
- The red waveform is the control voltage for the VFD’s output contactor

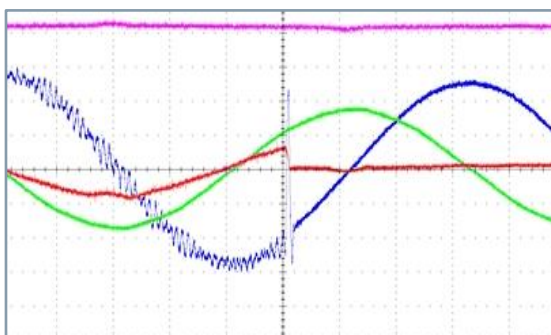

Figure 12: Optimized Synchronous Up Transfer

As shown in the graph, there is no observable change in motor voltage or current. This means that there is no meaningful change in motor torque during an “up” transfer, and it is synchronized with the line phase and frequency.

Optimized Synchronous Transfer of Motor to the VFD (Down Transfer)

Optimized synchronous transfer of the motor to the VFD operates almost identically to the traditional SINAMICS Perfect Harmony GH180 “down” transfer method. All existing logic which was used previously can be applied to the optimized synchronous transfer.

The VFD output is connected in parallel with the motor. When the VFD senses the voltage on the output, it synchronizes with this voltage. Once synchronized, the VFD signals to open the motor’s line contactor. Once the motor’s line contactor opens, the VFD starts operation without waiting for the line contactor open signal.

The chart below is a capture of an optimized synchronous “down” transfer:

- The magenta waveform is the motor voltage magnitude
- The red waveform is the VFD output current
- The blue waveform is VFD/Motor voltage

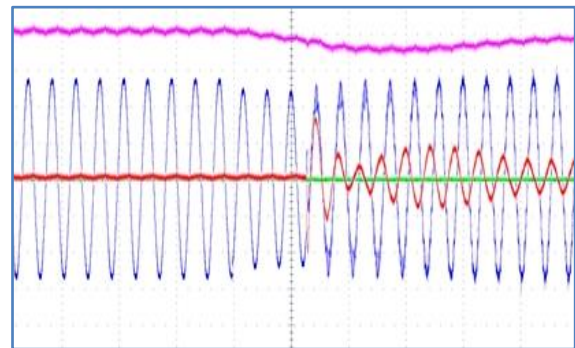

Figure 13: Optimized synchronous down transfer

The graph shows negligible effect of the zero torque state. During the time between the opening of the motor’s line contactor and the VFD starts operating the torque of the motor will be zero. During “down” transfer the SINAMICS Perfect Harmony GH180 uses sophisticated sensing to determine the state of the line contactor. This sensing will adapt automatically to the application. This approach prevents timing issues and greatly reduces the process impact caused by the brief zero torque state.

Additional Considerations

There are a few rare cases that require additional analysis before using optimized synchronous transfer solution:

- excessive system short circuit current ratings:
 - for smaller drives (40-70A), the short circuit current at the drive’s input should not exceed 35kA,
 - the short circuit current should not exceed 200 times of the drive’s rated output current.
 - In these cases, a 1% reactor is required.

- excessive torque variations during steady state operation, and
- extremely low motor/load inertia, for example electrical submersible pump application.

If your site or load falls into this category, the optimized synchronous transfer may be modified to fit your application. If this is not possible, the traditional synchronous transfer remains available to ensure all applications have the opportunity to use synchronous transfer for bypass operation.

Summary

The optimized synchronous transfer system allows for bypass operation without the need for an output reactor.

- Optimized and traditional synchronous “up” transfers are equivalent with no interruption of motor torque.
- Optimized synchronous transfer has a brief torque interruption during “down” transfer operation - interruption is kept brief by an adaptive algorithm which senses contactor status via motor behavior

When selecting the synchronous transfer option, Siemens recommends that customers install motor protection relay (MPR). Once the motor is transferred directly on line, it is no longer protected by the VFD. In case of the multi motor synchronous transfer option (N18), Siemens integrates an MPR with associated CTs and PTs into the switchgear line-up. If switchgear is supplied by the customer (L20), it is customer responsibility to install the MPR.

For both options, Siemens provides a synchronous transfer controller with predefined and tested logic up to 8 motors and built-in HMI for display. The controller can be installed as a part of the line-up or separate in a control room depending on customer requirements. Siemens solution is the most flexible and provides support for the customers’ selection of switchgear and motor protection relay to ensure the best fit for their site and application.



Unmanned Station Solution

Many pumping and compressor stations are often located remotely where input power is more susceptible to disruptions caused by line surges, dips, and short outages. These can cause nuisance trips that lead to loss of production. In such cases equipment including its control needs to be robust to withstand these events. Most stations are unmanned and continuously operated and monitored to ensure safe operation. If there is a trip, there is additional cost associated with travel time to reset the equipment and restart the process.

Unmanned Station Option (S17) for SINAMICS Perfect Harmony GH180 provides features and functionalities that maximize customer uptime by providing robust control and input line tolerance capabilities. If customer selects this option, the following features will automatically be implemented unless otherwise specified by the customer:

- Automatic fault reset - certain faults within a drive can be reset automatically
- Automatic restart - switches the drive on again when the medium voltage is restored after a power failure or a general fault, the drive then ramps up the motor to the current speed setpoint. The number of restarts and the time delay is customer specified to provide additional flexibility and accommodate various site requirements.
- Local display and classification of faults and alarms to indicate to a customer:
 - Whether a drive experienced the fault and it was reset automatically
 - Or there is a fault and it is safe to reset remotely
 - Or it is recommended to go to the site for inspection prior to fault reset.
- Robust process tolerant control logic is enabled. The drive is designed to operate continuously with reduced torque down to 66% of available input voltage and fault free ride through of power loss up to 30 cycles to ensure equipment trip free operation.

Recommended option for the switchgear/circuit breaker:

- An integrated, electric-racking system, that includes a fixed-mounted, high-torque motor and logic control module powered by control power in the switchgear or an external supply (either 120 VAC or 125 VDC) when necessary. One control pendant is supplied per lineup. Siemens offers SIERS integrated, electric-racking system.

Other options recommended but not required for customer who selected this option:

- L53 - UPS supply to the control section is required to provide fast response during power losses up to 8 minutes for stations where low voltage network does not have an UPS back up.
- Serial communication option (G22-G91)
- Process Tolerant Protection Strategy (ProToPS™) option (U10)

Electrical Submersible Pump Application

Approximately 90% of all oil wells require some form of artificial lift to improve oil flow. Electrical Submersible Pump (ESP) is one of several methods used in the industry. Once the oil reservoir stops producing oil under free flow, electrical submersible pumps are used to pump the oil to the surface.

Historically, low voltage drives have dominated in ESP applications, but recently more and more end-users are considering and using medium voltage drives. An ESP is a centrifugal pump that is driven by a medium voltage electric motor that ranges from 1000 V to 4800 V.

More often than not, ESPs are installed in remote locations. The power is more susceptible to disruptions from outages, poor voltage regulation, and transient voltage conditions. The design, operational and site constraints make these motors sensitive to the following conditions:

- Input line overvoltage and transient spikes
- High inrush torques
- High dv/dt
- Torque pulsations

One of the most common ESP motor and cable failures is short-circuited motors and cables. The reason for short circuit events is insulation break down. The LV drive solution, if not properly selected and engineered, may produce high output voltage spikes that lead to insulation break down of both cable and motor. The ESP failures have a very high cost. The total cost to an end-user of one ESP failure is about \$154K. Below is the breakdown of the average cost associated with the onshore ESP operation:

- Average loss of revenue $\$60 \times 200 \times 7 = \$84K$ based on:
 - Price per barrel - \$60 (can be as high as \$100 depends on market conditions); average oil production per well: 200 bopd (barrels of oil per day) and average workover & waiting time: 7 days
 - Average intervention cost is \$20K (maybe higher depending on a cost and availability of a rig) and average equipment cost of \$50K

SINAMICS Perfect Harmony GH180 provides the best solution for this application. Siemens has over 1000 units installed globally in this application alone. It offers inherent almost sinusoidal output voltage waveform, low harmonics and negligible torque pulsations:

- Less than 1% VFD induced torque ripple for any given frequency: no motor heating and no bearing wear
- 13 level output waveform line to line and small output voltage steps (1.3kV): no voltage spikes at the motor
- No need for filters up to 7500ft (2.3km)
- Waveforms remain high quality at lower speeds

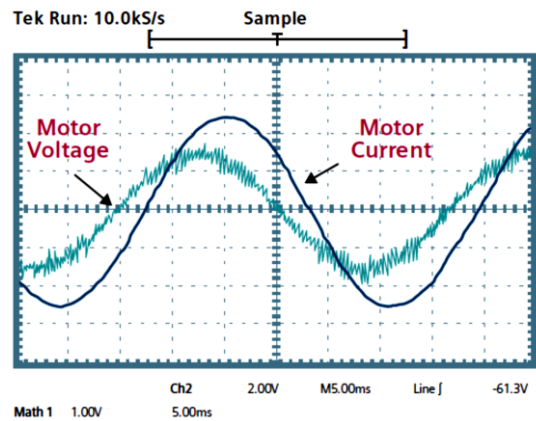

Figure 14: SINAMICS Perfect Harmony GH180 Output waveform

SINAMICS Perfect Harmony GH180, 9 cell, 54 pulse configuration waveform:

- Meets the most stringent requirements for voltage and current harmonic distortion, even if the source capacity is no larger than the drive rating
- Less than 3% total voltage distortion
- Less than 3% total current distortion

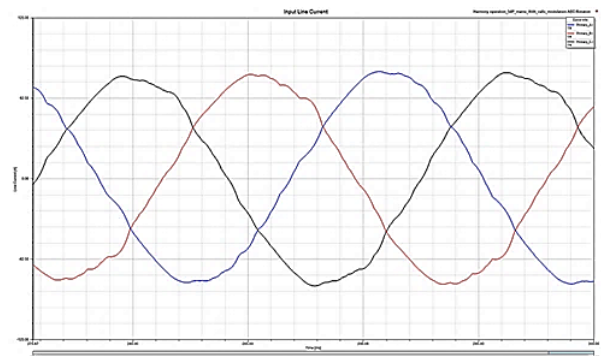

Figure 15: SINAMICS Perfect Harmony GH180 Input waveform

In addition, the SINAMICS Perfect Harmony GH180 provides the following benefits compared to a LV solution:

- No step-up transformer needed, the drive has direct feedback from the motor - output voltage ranging from 1.8 kV volts up to 4.16 kV
- No restriction on starting torque - 100% of torque is available at 1.6Hz speed - this would significantly reduce motor stress compared to kick start of LV drive
- When pump gets stuck due to sediment collection, the drive can produce 150% of rated torque required to free the motor or if additional effort is needed drive can engage "rocking" function to free the pump
- In locations that have frequent lightning storms, the drive offers standard distribution arrestors to provide protection to drive, cables and motor
- Flexibility with simplified and optimized input voltages from 480 volts up to 7.2 kV.

Torque During Ride-Through

ESP applications typically operate in regions where momentary power interruptions occur. These momentary power interruptions cause a loss of input power feeding the drive. The drive will respond by entering a mode called ride-through. The VFD performance during the voltage sag tolerance and ride through of momentary power loss depend on the amount of capacitance available in the DC link. The tolerance level varies from manufacturer to manufacturer and ranges from 90% to 75% of nominal input voltage.

At full speed, the SINAMICS Perfect Harmony GH180 provides regular operation for dips down to 90% of nominal voltage. After that the drive output power is rolled-back linearly from 100% power at 90% of input voltage down to 50% power at 66% of nominal input voltage. Output power is reduced by limiting the available motor torque. The VFD can operate continuously in this mode. When the input voltage falls below 66%, then the power is quickly reduced to a slightly negative value (regenerative limit) (figure 16). This limit forces the drive to absorb power from the motor and maintain the DC bus voltages in case the input voltage recovers during MV ride-through.

This typical ride-through action is the most effective drive response for most applications. However, some applications with very low system inertia and high loads are willing to sacrifice ride-through duration to maintain enough torque to prevent stopping the process.

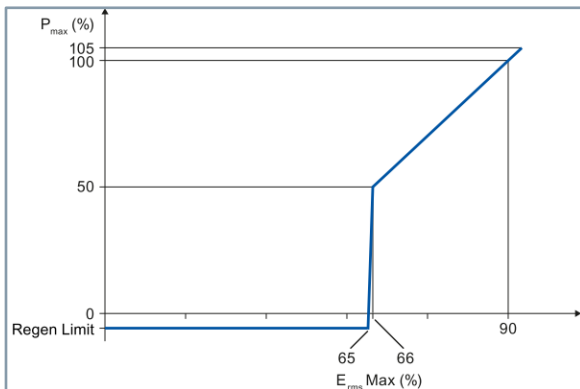

Figure 16: GH180 torque during Input voltage sag and ride-through

ESPs have low system inertia and a high load. Losing torque, even for a short time, will cause the flow to stop and reverse direction. At this point, one must wait for the column of fluid to drain back through the pump and sediment to settle before restarting the pump. Once started, one must refill the column of fluid before production is restored. This all wastes energy and time resulting in less revenue.

Given the cost of time and energy to restore production in ESP applications, it is more important to maintain the process through application of torque during a short power interruption than the ability to instantly reapply torque after an extended power interruption.

Solution

For applications such as ESPs, SINAMICS Perfect Harmony GH180 drives implement a scheme which allows to maintain some torque for a short time during ride-through. The power for this torque is the power stored within the DC filter banks of the power cells.

During ride-through, drive will provide torque to hold a preset speed for up to 100 milliseconds (5 cycles). After this period, the drive returns to the original ride-through algorithm where a slight regenerative torque is applied, and motor flux is maintained until DC power is exhausted or line voltage returns.

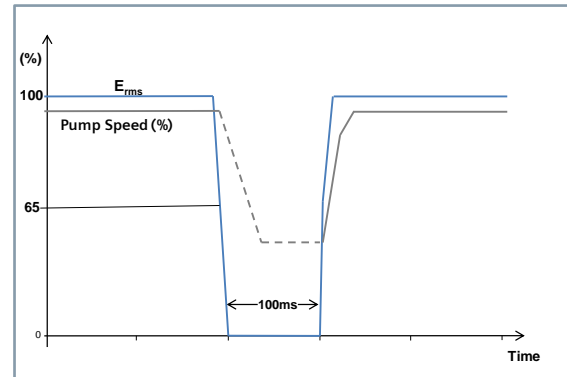

Figure 17: Typical pump speed response during extended torque ride-through

Summary

Extended torque ride through uses the energy stored in the DC filter capacitors to extend the torque available from the drive when a brief power interruption occurs. The benefits are:

- Enough torque is supplied to maintain minimum flow to prevent pump cavitation
- No reverse flow following momentary power outages
- No waiting for the column of fluid to drain sediment to settle before restarting
- No wasted energy refilling the column of fluid before production begins

Outdoor Duty Drive

Siemens offers standout flexibility with a full range of solutions: Outdoor Duty Drive for drives up to 1000HP (746kW), Containerized NEMA 3R solution up to 2000HP (1400kW), or Power Distribution Center (PDC) for all power ratings. The Harsh-Environment Drive Solutions have been successfully deployed to protect drives against a wide range of harsh conditions. These conditions include:

- Heat, dirt and sand at remote stations in the deserts of West Texas
- Subarctic temperatures -40°C (-40°F), snow and ice on the north slope of Alaska
- Air contamination and cold temperatures in the Canadian oil sands
- Salt and shipboard conditions in the Gulf of Arabia

Containerized NEMA 3R and PDC are fully engineered according to customer specific requirements and projects, while an outdoor duty drive is standardized for optimal solution. SINAMICS Perfect Harmony GH180 is the only medium voltage drive that offers Outdoor Enclosure Type 4 option and is also third party certified by both UL and CSA.

The environmental extension of SINAMICS Perfect Harmony GH180 provides reliable operation in remote locations and offers additional flexibility for those customers that have limited space. Siemens Outdoor Duty Drive has the following features:

- Exceeds NEMA 3R standard: customer can rest assured that even during severe storms their equipment is safe with Type 4 option that is designed to protect from falling dirt and windblown dust, rain, sleet, snow, and splashing water.
- Integral Air-to-Air Heat Exchanger creates separate airflows within the enclosure: one for outdoor air and a separate one for drive internal air flow. This provides a completely closed system which keeps dirt, moisture, and other elements from getting into the equipment.
- In addition to full insulation, the drive is equipped with advanced scheme for temperature and humidity control to prevent condensation to ensure safe operating conditions.
- Drive has built-in arrestors to protect transformer from current surges caused by lightnings.
- Maintain consistent temperature control, even in environments approaching -45°C (-49 °F) up to +45 °C (113 °F)
- Reduced maintenance requirements since there are no filters and accumulated particles in the heat exchanger can be easily washed.

Outdoor duty drive has the following standard options:

- Three cables In, three cables out (N73) for low voltage input
- Input voltage 460 - 575V with integral circuit breaker

- Mechanical key interlocks provide security (M08)
- Off-Local-Remote selector switch (K31) provides the ability to choose between off, local control and remote control of the three-position selector switch via I/O terminal strip.
- Anti-condensation heating for cabinet (L55)
- The drive is equipped with UPS (L53) to maximize your up time during low voltage power interruptions. The UPS provides back up power for the drive control and is configured for a buffer time of up to 8 min.
- Earthing studs (N94), this option provides protective grounds to create an electrically safe work condition during maintenance.
- Ethernet port (G47)

Other available options include:

- Integral fused switch disconnect for input voltage 2.4 to 7.2kV
- Communication protocols:
 - Modbus RTU interface (G22)
 - DeviceNet profile 12 (G23)
 - ControlNet (G26)
 - Modbus Ethernet (G28)
 - ETHERNET/IP (G37)
 - PROFIBUS DP (G91)
- Redundant fan for drive (M61) and redundant Fan for heat exchanger
- Cell bypass (U11) provides higher level of system availability and process reliability. In less than a quarter of a second (250 ms), the GH180 drive can bypass failed cells and maintain a balanced output voltage.
- Single redundant cell (U12); processes that cannot tolerate a reduction in drive power at rated speed when one cell is in bypass should select cell redundancy option.
- Drive status display with five signal lamps (K20) that shows the operating status of the drive: Fault, Drive ready, Alarm, Local operation, Operation

Outdoor Duty drive is available for 9 cell configuration: 2.3 to 4.16kV output voltage and 40 to 140A output current.



SINAMICS Perfect Harmony GH180 54 Pulse Solution

IEEE 519-2014, "Recommended Practices and Requirements for Harmonic Control in Electric Power Systems," is the standard for input harmonics in North America. It recommends limits for individual harmonics and total distortion. The goal is to limit harmonics at Point on a Public Power Supply System Coupling, defined as the utility/customer connection point, focusing on current distortion limits for the user and on voltage distortion limits for the supplying utility.

The primary reason for harmonic distortion is non-linear loads including but not limited to VFD. Such loads draw non-sinusoidal currents from the power supply which, in turn, causes distortion in the voltage waveform at the point-of-common coupling. This distortion may impact other customers by reducing system efficiency or adding additional stress for equipment connected to the same power supply.

Siemens traditional implementation has a proven record that the performance of an 18-pulse drive is within the limits of IEEE 519. Typically, a VFD with 9 cell configuration lowers harmonic distortion at its input by phase shifting its transformer windings. The windings (one per each phase) are shifted 20° apart to achieve 18 pulse. As shown in Figure 18, with an 18-pulse VFD input, the current THD is 3.5% — well below the 5% limit set forth by IEEE 519. Telephone Interference Factor (TIF) is 114.

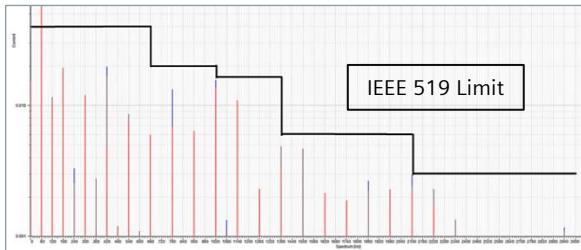

Figure 18: Input current harmonics with an 18-pulse VFD

As Siemens continue to improve performance of the SINAMICS Perfect Harmony GH180, we further reduce input harmonics with the same number of windings. Siemens new standard solution is 54-pulse 9-cell configuration. Each cell in SINAMICS Perfect Harmony GH180 has 6 pulse rectifier that in the past was shifted in the group of three (see figure 19). In the new configuration each individual cell winding is shifted 6.6° apart (see figure 19) to achieve 54 pulse rectification without additional hardware and does not affect the drive footprint. The new design offers more than 15% improvement in current distortion and more than 30% in TIF compared to 18 pulse configuration.

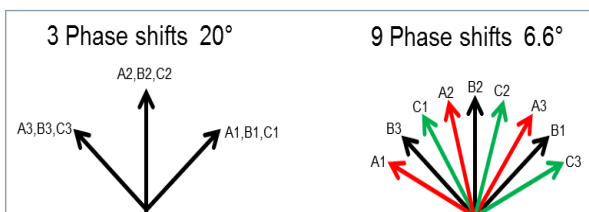

Figure 19: Example of transformer winding phase shifting

Example of harmonic spectrum of 54 pulse is represented in Figure 20, the data show THD of the current is 2.9% and the TIF is 77.

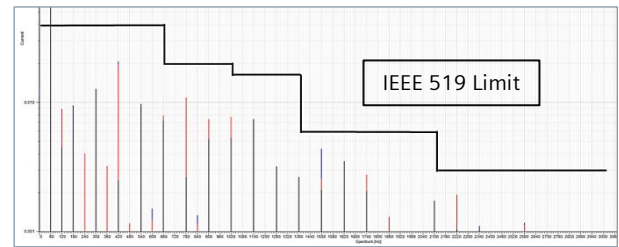

Figure 20: Input current harmonics with an 54-pulse VFD

IEEE 519-2014 defines levels for Total Current Demand Distortion (TDD(I)). Most manufacturers measure and show cumulative amount of harmonic distortion or Total Harmonic Current Distortion (THD(I)). IEEE requires distortion measured at 100% load at this point THD equals to TDD. The improvement in current waveforms is shown in Figure 21.

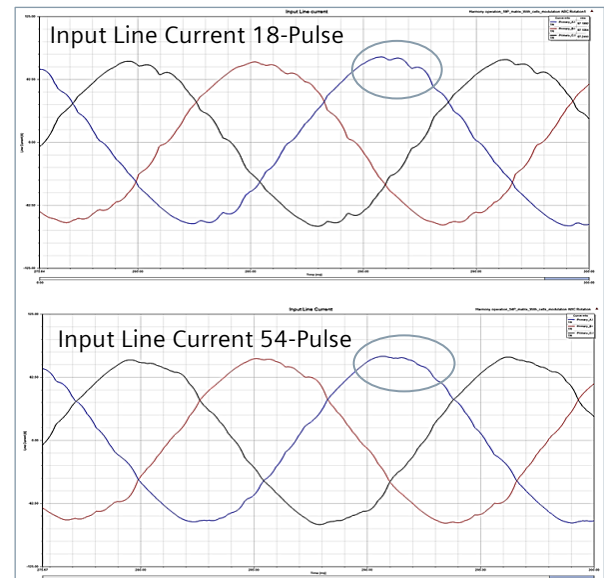

Figure 21: Input Line current waveforms

An additional benefit of 54 pulse solution compared to 18 and 24 pulse configurations is cancellation of higher order of harmonics. Typical harmonic cancellation based on number of pulses:

- 18 pulse: 5, 7, 11, and 13
- 24 pulse: 5, 7, 11, 13, 17, 19, and 23
- 54 pulse: 5, 7, 11, 13, 17, 19, 23, 25, 29, 31..., 47 and 49

The harmonics measurements mentioned in this discussion are based on ideal steady state operation of the drive and assuming the power supply network is symmetrical and free from harmonics. In real world conditions, the supply networks or connected equipment never follow the ideal environment and therefore, the actual measured harmonics would not be exactly as calculated or simulated. Our theoretical analysis and simulations for 54 pulse design were completed and verified by actual field testing and data.

SINAMICS PERFECT HARMONY GH180 Water-cooled drive



SINAMICS Perfect Harmony GH180 water-cooled drives designed to provide output power from 4,000HP to 33,000HP (3 to 24.6 MW) in a single channel and output voltages from 3.3kV to 11.0kV.

To support critical high power applications, Siemens redesigned its SINAMICS Perfect Harmony GH180 water-cooled drive to be 20% more compact and more powerful with cell current rating of 1375A. The new streamlined design offers the same proven reliability and performance as before, but within a smaller footprint and additional configuration flexibility that makes it even more versatile.

The result is a simplified system that's composed solely of a transformer cabinet, cell cabinet and cooling cabinet. There's less programming needed, and fewer components with fewer connections means maintenance time is minimized, too.

Reliability is improved by reducing the number of threaded fittings on the water-cooled VFDs and replacing long hoses with copper pipe. Every aspect of the drive is optimized to fit small spaces while remaining compatible with — and delivering superior reliability to — virtually every application.

Built-In Safety

The inherent benefit of the distributed power structure of the PERFECT HARMONY multi cell topology results in significantly reduced fault energy stored in the inverter section (equivalent of the low voltage drive) as compared to other available technologies. To provide additional protection, every SINAMICS Perfect Harmony GH180 water-cooled drive includes the Arc Detection System as a standard feature in power cells since its design in 2006.

The inverter section consists of cells equipped with arc detection sensors and the control to communicate with the drive system. This communication is supported by the Advanced Protocol software. In the rare event of cell arcing, the Advanced Protocol will initiate the shutdown of the inverter within 20ms and the drive control will issue a trip signal to an external breaker.

When combined with suitable fast acting circuit breakers on the input and output circuits, the SINAMICS Perfect Harmony GH180 VFD can be effectively disconnected from the input line and the motor in a short duration. Recommended total opening time of the circuit breaker

must not exceed 80. The drive monitors the total opening time.

The purpose of Arc-Fault Detection is to minimize the impact of the arc by reducing the time needed to trip the circuit breaker and interrupt the fault.

Advanced Cooling Cabinet Option

Customers that require high level of monitoring and redundancy will benefit from Advanced Cooling Cabinet Option (W04). This option offers a larger cabinet to provide easier access to components and for easier maintenance. To support maintenance, the cabinet has a built-in hoist and rail system for changing the pumps. The pumps are equipped with two low-voltage variable speed drives for better motor control of the pumps which, in turn, increases the reliability, efficiency and life of the pumps. Automatic switchover between pumps will occur in the event of one of the pumps failure or loss of flow. The customer has the freedom to program pump cycling based on their system requirements. The advanced cabinet supports both air-to-water and water-to-water heat exchangers.

There are several signals available for remote monitoring through customer SCADA or plant HMI to provide timely feedback on performance of the entire cooling system including external heat exchanger. Increased monitoring allows for advanced indication of coolant system issues before the drive control issues an alarm or trip. These signals include:

- water level
- flow
- conductivity
- pressure and temperature
- In addition to pump status, pump VFD status is also available for remote monitoring
- individual fan monitoring/status of the external air-to-water heat exchanger.

SIDRIVE IQ

With SIDRIVE IQ, customers can breathe easy knowing that Siemens experts are continuously monitoring and analyzing the health and operating conditions of their drive train equipment remotely from our Service & Support Center.

Siemens provides valuable insights into equipment health as a service to maintenance personnel, which enables them to be notified and to act, often before the equipment breaks down.

It's like having your own drive train expert on staff – working together with maintenance personnel 24/7 and taking care of your drive train equipment with real-time intelligence. In the unlikely event of downtime SIDRIVE IQ optimizes the time it takes to get equipment back online by transferring the right data to the right Siemens expert in the fastest time possible. This enables Siemens to immediately analyze and provide recommendations and corrective actions to resolve the issue. The result: overall improved uptime and reliability of the drive train system.

Siemens SIDRIVE IQ is available for medium voltage Siemens VFDs.

How It Works

Implementing SIDRIVE IQ begins by collecting data from the sensors on the motor and the control unit in the Siemens SINAMICS VFDs. This data is then sent to a MindConnect device – a hardened Siemens SIMATIC industrial PC. This IPC creates a direct and secure one-way connection with MindSphere, a Siemens cloud-based, open IIoT operating system. MindSphere provides state-of-the-art security during data acquisition in the field, transmission, and storage via the cloud. The security framework of MindSphere is aligned to the principles of industry standards (IEC 62443, ISO/IEC 2700) and governmental recommendations for data handling in cloud environments.

Siemens SIDRIVE IQ technology is now available as an option for your new drives. With this option, your drives can be shipped ready to connect to the Siemens Mindsphere IIoT platform and the Siemens Drive SIDRIVE IQ service via secure WAN connection.



This valuable service enables further improvement of equipment reliability and process availability, minimized unplanned downtime, and optimized total cost of ownership. With the SIDRIVE IQ service:

- Siemens 24/7/365 VFD experts are notified immediately of a trip or unexpected event through secure one-way-only digital connectivity
- The experts have access to real time failure logs and trend data to diagnose problems and help you get your production back online in the shortest time possible
- Regular monitoring of critical VFD and motor performance information and health status enables many problems to be identified and handled in advance
- Real time operations and health status and critical parameters can be accessed remotely through a user-friendly dashboard and secure one-way-only data transfer, allowing you to securely watch the operation of your drive system anywhere

By implementing this feature in the factory, you won't only save money, but also enable the digital fingerprint of the drive to be taken before shipment. All key performance measures are recorded during factory testing so they may be utilized for improved troubleshooting, analytics and diagnostics in the future.

Upon request, Siemens can provide detailed information and a proposal for this feature.

Features	Benefit
Automated Notifications and Accelerated troubleshooting	<ul style="list-style-type: none"> • Early notification of abnormal behavior or condition • Immediate transmission of relevant data to Siemens expert • Accelerated analysis by Siemens expert using real time equipment data
Web-Based Customer Dashboard	<ul style="list-style-type: none"> • Real time transparency into critical performance parameters and KPI's anywhere with internet access • Trend data and identify patterns over time to assist in maintenance
Automated Health Report (Monthly)	<ul style="list-style-type: none"> • Summarizes the operation and health of the monitored components • Provide prescriptive recommendations
Motor Predictive Maintenance Report	<ul style="list-style-type: none"> • Predictive maintenance recommendations for motors

Engineering Tool SIZER WEB ENGINEERING

Overview

This catalog is designed to serve as a reference point and does not cover all possible configurations with ordering data including Article Number or MLFB. If you can not find the configuration in this document, Siemens provides an online tool that guides through product selection with ordering data and option codes available for you to send to your Siemens Representative for further discussion.

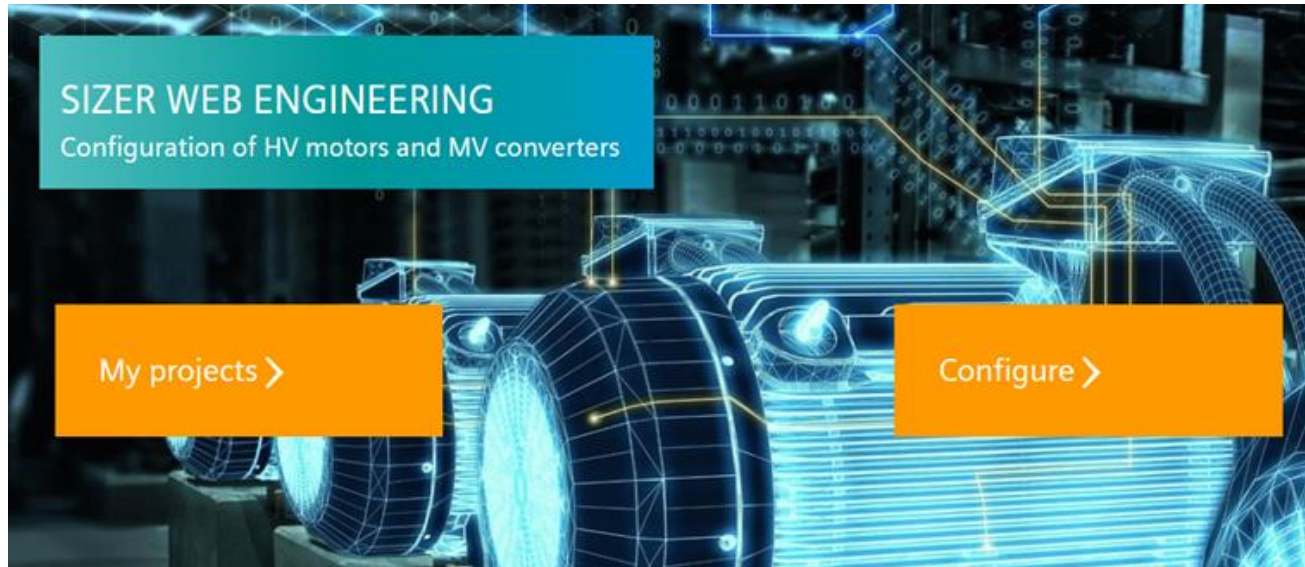

Flexible, customized and user-friendly

With the web-based drive engineering tool you can quickly find the solution for your drive application: Menu-prompted workflows specifically guide you when you are selecting and dimensioning products and drive systems – including accessories. Via an integrated query function, SIZER WEB ENGINEERING can also provide you with customized special solutions for applications that cannot be addressed using “Standard Products”.

SIZER WEB ENGINEERING is the entry point for the configuration of HV motors and MV converters and provides the following features:

- Modern user interface, easy to handle
- Easy project management
- Document generation
- Guided selection tools for HV motors and MV converters to support the preselection of applicable product groups

Comprehensive documentation such as data sheets, starting calculations, dimension drawings, quotation documentation – to name just a few – are a fixed component of this tool. The result: customized solutions for your drive tasks.

Additional information

- Further information about the SIZER WEB ENGINEERING tool is available on the Internet at: www.siemens.com/sizer-we
- Home page "Selection and engineering tools": www.siemens.com/engineering-tools

PERFECT HARMONY GH180 Option Description

Availability Options

Option	Description
U11	<p>Advanced cell bypass</p> <p>Cell bypass provides a higher level of system availability and process reliability. In less than a quarter of a second (250 ms), the drive can bypass failed cells and maintain a balanced output voltage. With one cell in bypass, the drive still produces sufficient voltage to allow the process to continue uninterrupted, and the quality of the voltage and the waveform remain virtually unchanged.</p> <p>To ensure the most reliability and availability, the VFD is equipped with mechanical cell bypass with independent power supply and control communication. This cell bypass can be tested and demonstrated during witness testing.</p> <p>Loss of cells reduces the drive's power capability; torque is reduced only when the drive's power capability exceeds the designed limit. Faulted cells can be replaced at a convenient planned maintenance window.</p> <p>For some applications with low load inertia, such as an ESP, during the cell bypass the speed may rapidly decelerate. In such applications where a process trip may be issued by the system control, use of manual cell bypass is recommended.</p> <p>Manual cell bypass is configured in the drive operating system. When a cell fault occurs, the drive will trip on the cell fault. The user can reset the fault, which triggers a cell bypass, and can then proceed to re-start the drive. The reset can be done through plant HMI or SCADA.</p>

Option	Description
U10	<p>Process Tolerant Protection Strategy - ProToPS™</p> <p>With a proven record of 99.99 percent process uptime, ProToPS™ protects the customer process from faulty sensors or data. ProToPS™ offers a proactive control strategy for applications where failure avoidance is critical. It provides a hierarchical system of warnings in advance of potential drive system trip. This control strategy allows time for the operator to evaluate the situation and respond appropriately to avoid a system shutdown.</p> <p>This option requires advanced cell bypass (U11) and redundant blower (M61) for maximum performance.</p>

Option	Description
M61	<p>Redundant blower</p> <p>To improve system availability, an additional blower is added to the air-cooled drive. If a blower fails, the cooling system is automatic switched over to redundant blower to ensure uninterrupted drive operation. A fan alarm fault will be annunciated. This prevents production down time or disruptions</p>

Option	Description
L53	<p>UPS for power supply of the control</p> <p>In the instances where UPS back up for low voltage network is not available on site, the drive can be equipped with a UPS to maximize up time during low voltage power interruptions. The UPS provides back up power for the drive control and is configured for a buffer time of up to 8 min.</p>

Note: Option L53 is available for 120 V or 220V AC only.

Option	Description
L85	<p>Redundant control power</p> <p>This option provides a second low voltage network control input with automatic switch over to prevent unnecessary interruptions and down time in case the first low voltage supply fails. This option includes UPS.</p>

Note: It requires an additional cabinet. This is the GH180 water-cooled drive option.

Cell Redundancy

Processes that cannot tolerate a reduction in drive power when one or more cells are in bypass should select the cell redundancy option. This option significantly increases drive availability when long intervals between services are required. This option is scalable depending on your process requirements. Cell Redundancy options require cell bypass.

Option	Description
U12 AC	N+1 cell redundancy
U21 WC	Drives with N+1 Cell Redundancy option provides rated power operation with one cell bypassed.
Note:	Not available with all output voltages
U13	<p>One redundant cell per phase</p> <p>Option U13 provides full output power with a bypassed cell in each phase. This option adds extra three cells to the drive (one cell per phase).</p>
Note:	Option U13, requires cell bypass option (U11) and redundant blower (M61). U13 is air-cooled option
U22	<p>Drives with N+2 cell redundancy</p> <p>This option provides rated power with two cells bypassed. This is water-cooled only option</p>
Note:	Not available with all output voltages

Safety Options

Option	Description
--------	-------------

M57 Arc resistant design 40-260A

Arc resistant option is designed to help minimize the risks associated with an arc flash event and provides increased protection of customers' personnel and equipment.

The equipment is designed to withstand or mitigate the effects of an internal arcing fault as indicated by an appropriate label meeting the test requirements of the following:

- IEC 62477-2:2018
- Associated protection required
- The details regarding associated protection used shall be provided by the manufacturer in the documentation.

This product successfully passed the following testing criteria:

- Accessibility Grade – Type 2B
- Short Circuit Current – 50kA up to 13.8kV
- Time Duration – 100 ms
- Frequency – 50/60 Hz

Associated protection: External fuses; general purpose current-limiting per ANSI IEEE Std C37.40, E-rated per ANSI IEEE Std C37.46, minimum 50 kA symmetrical interrupting rating.

Note: Available for 6SR52,40-260A, 150 – 2000HP. For other ratings, please, consult factory. This is air-cooled only option



Door Interlocks

SINAMICS Perfect Harmony GH180, 6SR5 drives are designed with bolted covers as a standard option. For customers that would like to have keyed access, there are 4 types of mechanical interlocks available depending on customer preference. Safety closing/interlocking system is based on the key transfer system. Typically, the circuit breaker is opened, and a feeder earthed to release a key to the drive key exchange unit which in turn releases the keys to the cabinet doors of the power section(s). This ensures that the drive is isolated from the input medium voltage and that the medium voltage is no longer present. The number of keys will depend on the number of cabinets.

Option	Description
--------	-------------

M08 Superior - mechanical door interlock

M09 Kirk - mechanical door interlock

M38 Fortress - mechanical door interlock

M12 Electrical door interlocks

The electrical door interlock system prevents access to the energized sections in the drive as long as hazardous voltages are present. This system also prevents the drive from being switched on until all doors of the energized sections in the drive are closed.

Note: GH180 air-cooled as a default is supplied with M09, Kirk key interlocks in North America or M12 Electrical door interlocks in Europe and China.

Option	Description
--------	-------------

N10 Prepared for input contactor

Input contactor allows customers to isolate medium voltage drive for maintenance or repairs purposes without disconnecting primary protection. This option is recommended when multiple medium voltage drives are installed at the single site connected to common upstream protection. The benefit of an input contactor is that it is capable to break full current while input disconnect only can be opened after primary protection is opened.

Selecting this option will add switchgear to the drive on the side. When option N10 is chosen, the appropriate switch gear sizing is automatically selected based on the other drive parameters.

Note The input contactor option is available when the primary input voltage is less than 7200V.

Option	Description
N13	<p>Prepared for input circuit breaker</p> <p>Input contactors are only available for input voltage up to 7200V. When input voltage exceeds this, a circuit breaker is an appropriate solution. Selecting this option will add switchgear to the drive on the side. When option N13 is chosen, the appropriate switch gear sizing is automatically selected based on the other drive parameters.</p>

Option	Description
N94	<p>Grounding studs</p> <p>This option provides protective grounds to create an electrically safe work condition during maintenance. The ground studs will be installed in the following locations: Input and output power terminations and ground pads. The terminations will be equipped with a ball type ground stud.</p> <p>Note: Grounding cable and/or clamps are not included</p>

Option	Description
N44	<p>Make-proof grounding switch at drive input</p> <p>With option N44, a grounding switch is installed at the drive input. The switch connects each phase to ground to prevent unexpected reconnections during maintenance.</p> <p>For safety reasons, the drive control locks the switches until there is no voltage present. The control is integrated into the protection and monitoring circuit of the drive.</p> <p>In the event of maintenance work on the drive, it must be ensured on the plant side that there is no external voltage present, e.g. auxiliary voltage for blowers, the cooling system, controller and closed-loop control and any external drive outputs.</p> <p>Note: This option for 9 cell air-cooled configuration requires an additional cabinet</p>
N45	<p>Make-proof grounding switch at drive output</p> <p>With option N45, a grounding switch is installed at the drive output. Some applications (ex: gas turbines or Permanent Magnet Motor) may regenerate and feed energy back to the drive. In such instances, a make-proof grounding switch is recommended. The switch connects each phase to ground to prevent unexpected voltage during maintenance.</p> <p>For safety reasons, the drive control locks the grounding switch against activation while voltage is still present. The control is integrated into the protection and monitoring circuit of the drive.</p> <p>Note: This option for 9 cell air-cooled configuration requires an additional cabinet</p> <p>Options N44 and/or N45 are recommended for applications within Europe.</p>

Control and Display Instruments

Option	Description
A30	<p>Touchscreen with standard cable</p> <p>Standard Siemens touchscreen with standard Ethernet cable will be provided on the door of the drive. Standard HMI shall be loaded with Tool Suite software only.</p> <p>Note: Air-cooled 9 cell configuration and all water-cooled drives require an additional cabinet</p>

Control Selector Switches and Push Buttons

These switches provide the customer with the flexibility to select preferred drive control mode: local through keypad, remote/auto control through digital inputs or serial communication.

Option	Description
K29	<p>Pushbutton / Potentiometer kit</p> <p>With option K29, a pushbutton kit is located on the door panel. It includes</p> <ul style="list-style-type: none"> – a start and a stop pushbutton – a fault reset button and a manual speed potentiometer <p>Emergency Stop pushbutton is standard.</p>
K31	<p>Off-Local-Remote selector switch</p> <p>Option K31 provides the ability to choose between off, local control and remote control of the three position selector switch via I/O terminal strip.</p>
K32	<p>Off-Hand-Auto selector</p> <p>A three position selector switch mounted on the front of the drive.</p>
K33	<p>Keyed Off-Local-Remote selector</p> <p>It offers the same functionality as option K31 but this option provides additional protection as it requires keys (password) to change the position.</p>
K34	<p>Keyed Off-Hand-Auto selector</p> <p>A three position selector switch mounted on the front of the drive provided with keyed protection.</p> <p>Note: Option K31 is the default setting.</p>

Option	Description
L50	<p>Cabinet lighting and service socket outlet</p> <p>This option includes a universal lamp and a service socket outlet (Schuko version) installed in the control cabinet. The voltage supply for the cabinet lighting and socket outlet (on terminal block) is provided externally. The cabinet lighting is switched on manually via a switch.</p> <p>Note: This option for 9 cell air-cooled configuration requires an additional cabinet. Air-cooled option only</p>

Auxiliary and control voltage supply

Option	Description
K69	Control voltage by Siemens This option provides control voltage that is generated internally from the auxiliary.
K68	Control voltage 220/230/240V AC by customer Using option K68, the customer will supply control voltage to the drive. Typical current consumption is 8 A. The internal control voltage will be 120 V AC in any case. For water-cooled drives, it requires an additional cabinet.
K73	I/O signal voltage 24 V DC This option provides 24 V DC that is available as I/O control signals.
K79	Control voltage 120 V AC by customer The customer will provide control voltage to the drive

Signal Lamp and Display Instruments

Signal lamps and display instruments are hardwired options that provide quick visual display of drive performance and health. The same parameters are also available through the drive HMI.

Option	Description
K20	Signal lamp in the cabinet door With option K20, five signal lamps that display the operating status of the drive are provided in the cabinet door of the control section. – Fault (red) - Drive ready (white) – Alarm (yellow) - Local operation (white) – Operation (green)
K21	Display instruments for voltage, current and speed For display of process variables, analog display instruments are installed in the cabinet door indicating the measured value in %: – Motor current (0 to +120 %) – Motor speed (-120 % ... 0 ... +120 %) – Motor voltage (0 to +120 %)
Note:	K21 option for NKN location requires additional cabinet



Controlled Outgoing Feeder for Auxiliaries

This option provides a control of outgoing feeder for the operation of external auxiliary equipment, e.g. separate blowers on the motor, anti-condensation heating for the motor or pump/oil supplies. It is controlled and protected by motor circuit-breakers. The contactor is switched on with the ON command at the drive and switched off with the OFF command. Should local regulations require earth leakage protection then that is done from the external feeder supply.

Option	Description
N35	Controlled outgoing feeder for auxiliaries 220 V or 120 V 1PH AC, max. 1.2 kW
N36	Controlled outgoing feeder for auxiliaries 220 V or 120 V 1PH AC, max. 2.2 kW
N37	Controlled outgoing feeder for auxiliaries 220 V or 120 V 1PH AC, max. 3.5 kW
N38	Controlled outgoing feeder for auxiliaries 220 V or 120 V 1PH AC, max. 4.5 kW
Note:	These options for 9 cell air-cooled configuration require an additional cabinet

Option	Description
L55	Anti-condensation heating for cabinet Anti-condensation heaters are recommended at low ambient temperatures and high levels of humidity to prevent condensation. The number of cabinet heaters fitted depends on the number of cabinet panels. The anti-condensation heaters are controlled with a thermostat.
Note:	This option includes over-temperature protection. The supply voltage for the anti-condensation heating (110 or 240 V AC) must be supplied externally. Should local regulation require earth leakage protection then that is done from the external feeder supply. If drives are placed in storage for any period of time, Siemens recommends anti-condensation heaters. The number of heaters depends on the size and quantity of cabinets in the drive.

N75	Power supply for external devices 24 V DC With option N75 the drive is delivered with a power supply unit for 24 V DC auxiliaries. It provides 6 output terminals each for +24 V and 0 V. The total power consumption across all output terminals is limited to 2.5 A.
------------	--

Heat Management Options

Option	Description
W41	<p>Drive prepared for air-to-air heat exchanger</p> <p>When this option is purchased, the drive is equipped with necessary plenums to ensure proper drive airflow when connected to the heat exchanger. The drive comes with the heat exchanger control box.</p> <p>All heat exchanger fan motors are wired to the control box and can be either mounted on the side of the drive or outside on the heat exchanger itself in the NEMA 4 enclosure.</p>
Note:	<p>The heat exchanger is standalone equipment specified and provided by Siemens. It is enclosed in polycoated housing with N+1 fans for 100% redundancy. The enclosure includes a top hat that directs the outside air horizontally out of the top of the unit. The top contains louvers to prevent a draft when the fans are not running. The heat exchanger requires outdoor installation by others.</p> <p>The heat exchanger can include optional provisions, such as integral space heaters and motor/fan assemblies designed for low ambient operation at up to -40° C.</p>

Option	Description
M64/ M68	<p>Drive prepared for duct flange connection in front/rear</p> <p>With these options, the drive is prepared for connection to an external exhaust air system, which shall connect to the front (M64) of the blower assembly or to the rear (M68) of it. Only one of the options per drive.</p> <p>These options are applicable when the customer is providing external exhaust ducting to carry the hot air blowing out of the drive cabinet outside the room.</p> <p>When configuring the exhaust air ducts for the drive ventilation system, it is essential to ensure that the air flow rates stipulated in the technical data are observed. The pressure drop between the air inlet and the air outlet of the drive is different for different configurations.</p>
Note:	<p>The following requirements shall be met when connecting to external air duct:</p> <ul style="list-style-type: none"> – Provide openings in the air duct to allow for the blowers' maintenance. – The cabinet doors can not be opened / closed after mounting the air duct. <p>This option can affect the values for sound pressure level depending on the design of the exhaust air system. For more details, please contact the factory or Siemens representative.</p>

Synchronous Transfer Options

Option	Description
L29	<p>Bidirectional synchronized transfer</p> <p>Option L29 provides the capability for synchronized, seamless transfer of the one motor to the line and take-over of the motor from the line. Before connecting the motor to the line, the converter synchronizes the motor to the supply/utility voltage phase, frequency and amplitude. Most applications do not require output reactor.</p> <p>Output reactor should be considered when the following conditions are present:</p> <ul style="list-style-type: none"> – Excessive system short circuit current ratings – Excessive torque variations during steady state operation, and – Extremely low motor/load inertia
Note:	<p>The circuit-breakers/contactors are not included in the scope of delivery. A motor protection relay should also be considered in the bypass circuit by the customer.</p>
N17	<p>Bidirectional synchronized transfer of one motor, switchgear provided by Siemens</p> <p>Selecting this option, in addition to synchronous transfer control function, it will add switchgear to the drive lineup. The appropriate switchgear is selected and sized automatically based on the drive parameters.</p>
Note	<p>Reactor-less bidirectional synchronized transfer is default. L09 must be selected if requested by the customer.</p> <p>A motor protection relay (MPR) is part of the scope and installed in the bypass circuit. Siemens integrates an MPR with associated CTs and PTs into the switchgear line-up. Customer is responsible for programming the MPR.</p>
Option	Description
L09	<p>Output reactor</p> <p>Depending upon the installation or application an output reactor may be required for bidirectional synchronized transfer. The output reactor decouples the converter output during the transfer process.</p> <p>For air-cooled drives the output reactor cabinet can be either included in the drive lineup with the same degree of protection as the drive or housed in a separate NEMA 3R/IP14 cabinet designed for outdoor installation.</p> <p>For water-cooled units, the water-cooled reactor cabinet will be included in the drive lineup with IP protection same as power section of the drive.</p>

Motor Protection and Monitoring

Option	Description
N18	<p>Bidirectional synchronized transfer of multiple motors, switchgear provided by Siemens</p> <p>With this option in addition to the Sync Transfer Control system, Siemens will add switchgear to the drive based on the number of motors handled by the drive and system setup. When option N18 is selected, the appropriate switchgear sizing is automatically selected based on the drive parameters. Siemens can provide switchgear based on the customer preferred manufacturer.</p>
Note:	When a customer selects synchronous transfer option Siemens recommends customers to install a MPR. Option N18 integrates a MPR with associated CTs and PTs into the switchgear line-up. Customer is responsible for programing the MPR.

Option	Description
L20	<p>Bidirectional synchronized transfer of multiple motors, switchgear provided by customer</p> <p>In the cases where the customer either has already all required switchgear or prefers to procure their own equipment, Siemens offers just the Sync Transfer Control system (STC) which provides for the synchronous transfer of two to eight motors directly to or from a line source of power. The system is designed to handle induction motors or synchronous motors and connection of motors to a source the same as the drive or to an alternate source. The STC has a local color HMI to support the configuration and status of the system. The STC can be mounted in the options cabinet, switchgear (if space available) or a separate enclosure. The synchronous transfer control logic can be demonstrated during the witness test.</p>
Note:	When customers select synchronous transfer option Siemens recommends customers to install motor protection relay (MPR). Once a motor is transferred directly on line it is no longer protected by the VFD. When switchgear is supplied by a customer, it is the customer responsibility to install and program the MPR.

Option	Description
A84	<p>Advanced Motor Protection and Monitoring</p> <p>Full featured integral motor protection and monitoring functions. The following functions included in the protection:</p> <ul style="list-style-type: none"> – Overspeed (12) – Machine Thermal Model (49T) – Zero sequence overvoltages (59G*) – Motor Short Circuit (50) – Motor Ground Fault (51G*) – Starts per hour (66) – Inverse Time Overcurrent (51) – Undercurrent (37) – Underspeed (14) – Underpower (37P) – Bearing Temperature RTD (38) – Mechanical Condition Monitoring (39) – Current Unbalance, Negative Sequence (46_2) – Incomplete Sequence – maximum start time/ maximum stop time (48) – Machine Thermal Overload RTD (49 RTD) – Power Factor (55) – Over/Under Frequency (81) – High Frequency Rate of Change (81) – Differential protection equivalent (87M**) <p>This option includes the SIMATIC S7, SM 1231 AI thermocouple 12 channel RTD unit. It is compatible with most three-wire RTD types:</p> <ul style="list-style-type: none"> – Pt100 is a default setting and others are available on request. <p>The status is sent through the drive serial network to a customer DCS or Plant HMI. All faults or alarms are stored and can be viewed through the drive event log.</p>
Note:	<p>*Ground Fault detection in SINAMICS Perfect Harmony GH180 is based on detection of voltage imbalance or residual voltage</p> <p>** Differential protection equivalent 87M=46_2+59G</p> <p>Customer is responsible for programing based on their motor and process data.</p>

Option	Description
A85	<p>12 Channel RTD monitor</p> <p>This option includes the SIMATIC S7, SM 1231 AI thermocouple 12 channel RTD unit. Each RTD input has an alarm and trip level. Thermal pickup setting is available in degrees C and F. Each RTD can be individually monitored.</p> <p>A wide range of three-wire RTDs is supported:</p> <ul style="list-style-type: none"> – Pt10, Pt50, Pt100, Pt200, Pt500, Pt1000, – Ni100, Ni120, Ni200, Ni500, Ni1000, – Cu10, Cu50, Cu100, LG-Ni1000. <p>Pt100 is a default setting and others are available on request</p> <p>Ambient temperature reading: min -145.0 °C max 145.0 °C</p> <p>Accuracy: ±1.0 °C</p> <p>Temperature min -200.0 °C max 850.0 °C</p> <p>Trip Temperature: Default: 150°C</p> <p>Range: 0°C to 572°C in steps of 1°C</p> <p>Dropout Level: Default 2%; range 0-50%</p> <p>Pickup Delay: Default 10 sec; Range 0-180 sec</p> <p>Dropout Delay: Default 5 sec; Range 0-180 sec</p> <p>Maximum Response Time: 50 ms</p> <p>The status is sent through the drive serial network to a customer DCS or Plant HMI.</p> <p>All faults or alarms are stored and can be viewed through the drive event log.</p>

Note: Customer is responsible for RTD programming based on their motor data. Distance between Motor RTD and Drive RTD input is 328 ft (100 m)

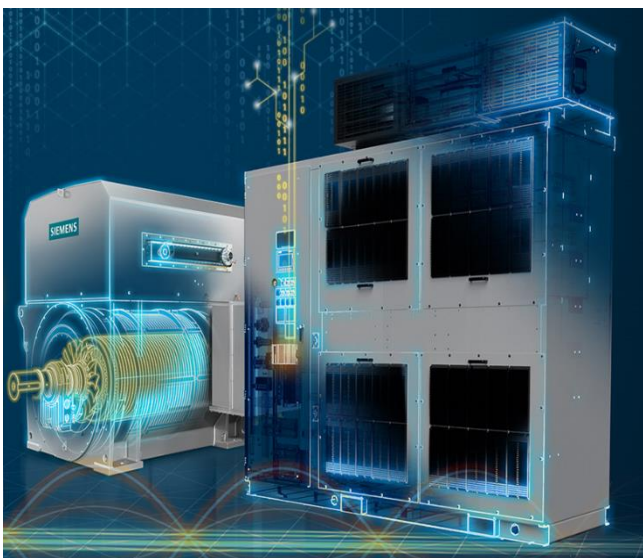

Option	Description
A80	<p>TEC System 12 channel RTD monitor</p> <p>A device installed in the drive to monitor motor temperature in windings and/or bearings. Basic 12-channel RTD monitor. Communication Protocol: None (default) RS 485 Modbus (option)</p> <hr/> <p>Note: Customer is responsible for RTD programming. If other protocols are required, please consult the factory.</p>
A82	<p>SEL 710 motor protection relay</p> <p>Full featured high-end motor protection/management relay with miscellaneous sensors monitoring capability installed. Communication Protocol: – none (default), – RS 485 Modbus (option). Includes output phase CTs and PTs</p> <hr/>
A83	<p>Multilin 869 motor protection relay</p> <p>Full featured high-end motor protection/management relay with miscellaneous sensors monitoring capability installed. Communication Protocol: – None (default) – RS 485 Modbus (option) Includes output phase CTs and PTs</p> <hr/> <p>Note: These options for 9 cell air-cooled configuration and water-cooled drives require an additional cabinet</p>

Option	Description
L81	<p>2 x 2 thermistor protection relays</p> <p>Option L81 includes four thermistor protection relays for PTC thermistors (type A) for alarm and trip. The power supply for the relay and the evaluation is provided in the drive.</p> <hr/>
L82	<p>3 x 2 thermistor protection relays</p> <p>Option L82 includes six thermistor protection relays for PTC thermistors (type A) for alarm and trip. The power supply for the relay and the evaluation is provided in the drive.</p>

Option	Description
L91	<p>2 Pt100 evaluation units with 3 inputs each</p> <p>Each Pt100 unit can monitor up to three sensors. For all three sensors, the limits for alarm and trip must be set centrally. The output relays are integrated into the internal fault and shutdown circuit of the drive.</p>
L93	<p>Pt100 evaluation unit with 6 inputs and 2 analog outputs</p> <p>The Pt100 evaluation unit can monitor up to six sensors. The limit values can be programmed by the user for each channel. In the standard setting, the measuring channels are divided into two groups of three channels each. With motors, for example, three Pt100 can be monitored in the stator windings and two Pt100 in the motor bearings. Channels that are not used can be suppressed using appropriate parameter settings.</p> <p>The output relays are integrated into the internal fault and shutdown circuit of the drive. There are two programmable analog outputs available (0/4 mA to 20 mA and 0/2 V to 10 V).</p>
L95	<p>Pt100 evaluation unit with 6 inputs for explosion-proof motors and 6 analog outputs</p> <p>For use in explosion-proof motors, Zone 2, Zone 22 (non-conductive dusts) Div. 2, and non-hazardous zones, six evaluation units are available (marking, explosion protection: II (1) GD (EEx ia) IIC/IIB and II 3 G EEx nAC II T4). The resistance thermometers can be connected using a two-wire, three-wire or four-wire system. The following temperature sensors can be connected:</p> <ul style="list-style-type: none"> – Resistance thermometers according to IEC 60751: Pt100, Pt500, Pt1000, – Resistance thermometers according to DIN 43760: Ni100, Ni500, Ni1000 <p>The alarm and fault messages are combined and integrated into the signaling and shutdown circuit of the drive.</p>
Note:	<p>The analog outputs are not evaluated by the control.</p> <p>The maximum cable cross-section that can be connected on the plant side is 1.5 mm². The cables for the intrinsically safe circuits are routed according to the layout diagram.</p>

Customer Communication, Interface and Control Software Options

Communication Options

As a default the SINAMICS Perfect Harmony GH180 drive provides an interface for our ToolSuite software that allows monitoring and configuring of the drive from a PC running windows operating system. Serial communication protocols and network communication are offered as options.

SINAMICS PERFECT HARMONY GH180 provides a wide range of protocols to meet customer requirements. As an option, customers may select an additional independent fieldbus as a backup (two networks maximum) in case the first communication network fails to avoid unnecessary interruptions.

The supported fieldbus protocols and drive control provide the capability to monitor up to 64 different drive and motor parameters according to the customers' application and specification. They can select from more than 200 parameters and variables available in the system.

Serial Communication

Option	Description
G22	Modbus RTU interface, network 1 RS 485
G23	DeviceNet profile 12 interface, network 1
G26	ControlNet interface, network 1
G28	Modbus Ethernet interface, network 1
G91	PROFIBUS DP interface, network 1
G37	EtherNet/IP interface, network 1
G32	Modbus RTU interface, network 2
G34	Profinet
G38	Modbus Ethernet interface, network 2
G39	EtherNet/IP interface, network 2
G43	DeviceNet profile 12 interface, network 2
G46	Control Net interface, network 2
G93	PROFIBUS DP interface, network 2

Option	Description
G50	VFD control via fieldbus network communication This option enables drive control via communication network (network 1 only). It enables control of the following parameters: speed control, start/stop and fault reset. Hardwired control is standard.

Note: Other parameters/functionality is available upon request. Control via network 2 is available as a separate option when dual networks are installed.

Network Communications

Option	Description
G42	Ethernet network switch with fiber optic port
G47	Ethernet port connector mounted on the door This port is used in conjunction with our ToolSuite software that allows one to monitor and configure the drive from a PC running windows operating system.

Option	Description
G19	SIDRIVE IQ Communication Converter The drive is equipped with an Ethernet converter for the ability to connect to SiDrive IQ.

Option	Description
K50	Closed loop vector control with provision for speed encoder This option allows for integration of an encoder signal feedback into the drive control through I/O. It is used in applications that require accurate speed control, especially at low speeds. Speed accuracy is up to 0.1% rated speed. Power to the encoder is supplied by the VFD.

Note: It is not available for Permanent Magnet Motors. Encoder itself is not part of the scope of supply.

Customer Interface

Option	Description
E04	Additional customer analog, digital Inputs and outputs (I/O) modules Drive has predefined analog and digital I/O associated with drive operation. Option E04 is offered when the customer process requires additional inputs and outputs. Below are the additional I/O that available with this option: – 6 digital inputs – 6 digital outputs – 2 Analog inputs – 4 Analog outputs

Note: This option for 9 cell air-cooled configuration and water-cooled drives require an additional cabinet

Control Software Options

Option	Description
S17	<p>Unmanned station option</p> <p>This option includes the following features unless otherwise specified by the customer:</p> <ul style="list-style-type: none"> – Automatic fault reset – Automatic restart - number of restarts and the time delay is customer specified to provide additional flexibility – Local display and classification of faults and alarms to indicate to a customer: <ul style="list-style-type: none"> • The fault and if it was reset automatically • A fault and if it is safe to reset remotely; • Or it is recommended to go to the site for inspection prior to fault reset – Robust process tolerant control logic is enabled designed to ensure equipment trip free operation

Note: Other options recommended but not required for customers who selected this option

- L53 - UPS supply to the control section
- Serial communication option (G22-G91)
- Process Tolerant Protection Strategy (ProToPS™) option (U10)

Mechanical Options

Option	Description
M42	<p>IP42 degree of protection</p> <p>As standard, 6SR4 air-cooled drives are supplied with NEMA 1 compliance. The corresponding standard degree of protection for the air-cooled drives is IP21. With option M42, the degree of protection can be enhanced over the standard offering</p>

Note: For 6SR5 drives, IP42 is standard

Option	Description
M79	<p>Copper system bus</p> <p>Drive will be delivered with plated copper system bus.</p>

Option	Description
M58	<p>Outdoor Duty Option</p> <p>This option includes the following features:</p> <ul style="list-style-type: none"> – internal Air to Air Heat Exchanger – RAL 9010 external paint rated for the environmental conditions – low voltage input of 480V and 600V [460V and 575V Nominal Utilization Voltage]. – input voltage range from 2.4kV to 7.2kV (400HP to 1000HP) – compliance to UL50e – outdoor environmental conditions from -45°C to +45°C – Certified by UL and CSA <p>Outdoor Duty Drive has the following default options:</p> <ul style="list-style-type: none"> – Three cables In, three cables out (N73) for low voltage input – Input voltage 460 - 575V with integral circuit breaker – Mechanical key interlocks provide security (M08) – Off-Local-Remote selector switch (K31) – Anti-condensation heating for cabinet (L55) – The drive is equipped with UPS (L53). – Earthing studs (N94). – Ethernet port (G47)

Note: For 6SR52 drives 9 cell configuration: 2.3 to 4.16kV output voltage and 40 to 140A

Gland Plates

Gland plates provide access for customer connections to and from the drive. As standard, the gland plates are aluminum.

Option	Description
M29	Painted steel gland plates
M35	Aluminum gland plates
M36	Brass gland plates
M37	Stainless steel gland plates

Cabinet Paint Options

Option	Description
M97	RAL 7035
M98	ANSI 61
Y09	<p>Paint finish other than standard</p> <p>A special color must be specified in plain text when ordering</p> <p>The cover of the filter mats will have the standard color even though the cabinet has a special paint finish.</p>

Altitude, Ambient Condition, and Transformer Options

Option	Description
U57	High temperature Temperatures up to and including 50° C
U58	Elevated BIL Elevated transformer BIL (basic impulse level). This is the next level up from the default BIL value.

Due to reduced air density at high altitudes, the VFD requires additional considerations to ensure that it works as designed. Both power section and transformer deratings are required. GH180 can meet these requirements without output voltage compromise - 100% of voltage available without step up transformer. Our cell boards are designed and tested to operate up to 4000m. In addition, NXG control has a sealed power supply version to ensure reliable operation at high altitude. Where applicable, this option includes elevated BIL (U58).

Option	Description
U60	High Altitude ≤ 1500m (5000ft) @ 40°C
U61	High Altitude ≤ 2000m (6600ft) @ 40°C
U62	High Altitude ≤ 2500m (8200ft) @ 40°C
U63	High Altitude ≤ 3000m (10000ft) @ 40°C
U64	High Altitude ≤ 3500m (12000ft) @ 40°C
U65	High Altitude ≤ 4000m (13300ft) @ 40°C



Option	Description
N26	Synchronized pre-charge and transformer pre-magnetization Remote locations with such weak lines where starting a large VFD can cause a voltage dip, synchronized pre-charge and pre-magnetization of transformer option is recommended. The inrush current is reduced to only 1 to 2 per unit. With option N26, the synchronized pre-charge option is configured and installed. It allows precharge of not only the DC-link capacitors in all power cells, but in addition, to build-up the input transformer flux in close phase relation with the incoming medium voltage feed; hence, minimizing the transformer inrush currents when the circuit-breaker is closed. When the synchronous pre-charge option is selected, a separate auxiliary voltage supply is required by others. This option is available for air-cooled 500-750A and water-cooled drives

Note It is the responsibility of the supplier of the auxiliary feed to ensure the voltage phase difference between the medium voltage feed and the auxiliary feed are within the +/-15 degrees tolerance and that there is the same frequency between the medium voltage input and precharge to allow proper operation of the synchronous precharge.

Option	Description
L36	Input Snubber Siemens recommends for the customer to provide a snubber on their existing input breaker to prevent high transients caused by the breaker following IEEE C57.142. if the customer cannot provide an input snubber Siemens can offer it as an option.

Cable Options

Option	Description
N50	Internal cabling with halogen-free cables With option N50, only halogen-free cables are used for cabling inside the drive. The insulating materials and color coding are in compliance with IEC standards (EN 50178/VDE 0160 (IEC 62103) and EN 60204-1/VDE 0113-1 (IEC 60204-1)).
Note:	Halogen-free cables are only used on units manufactured in Nuremberg, Germany.

Option	Description
N40	Internal control cabling with synthetic insulated switchboard (SIS) wire SIS wire is provided for the control section and blower control of the drive. It is traditionally used in the environments that require higher level of coating. It has thermosetting insulation which is usually heat resistant, moisture-resistant, and flame-retarding grade. It consists of a stranded copper conductor that is coated with XLP (cross-linked polyethylene) insulation.
Note:	The standard EPDM (ethylene propylene dienemonomer) cable is replaced with SIS wires in the following parts of the drive: the drive control and blower/pump control sections. DCR rack, cell and bypass pre-manufactured harnessed cables along with power cables are excluded from this option. This is air-cooled drive option only

Nameplate Options

Unless specified otherwise, standard is black phenolic nameplate with white letters. Use the following option codes to specify a nameplate other than the standard offering.

Option	Description
T03	White phenolic nameplate with black letters
T04	Stainless steel

Nameplate, Keypad, and Warning Label Languages

The options below specify the primary languages used for the drive nameplate, warning labels, and keypad selection buttons. The secondary language – always English – is used only on the nameplate and warning labels. It provides an English translation of the information listed.

Option	Description
T58	Nameplate, warning labels in English/French operator panel language in English
T60	Nameplate, warning labels in English/Spanish operator panel language in English
T74	Nameplate, warning labels in English/German Operator panel language in English An operator panel in German is only available in conjunction with option D00 (documentation in German).
T76	Nameplate, warning labels in English operator panel language in English
T80	Nameplate, warning labels in English/Italian operator panel language in English
T82	Nameplate, warning labels in English/Portuguese operator panel language in Portuguese
T85	Nameplate, warning labels in English/Russian operator panel language in Russian
T91	Nameplate, warning labels in English/Chinese operator panel language in Chinese
Note:	Please contact the factory or your local Siemens sales representative for languages different from the ones specified above.

Compliance Options

Option	Description
L03	EMC filter CE mark drives require an EMC line filter. With option L03, the filter will be installed downstream from the 3-phase control power disconnect switch.
Note:	Option L03 is required for the CE mark and is included in option U02.



Option	Description
U01	Version with UL listing (for base drive only) With option U01, a drive version for the North American market is supplied. It is approved and listed by the Underwriter Laboratories (UL). It includes option M08 (mechanical door interlocks – Superior). It requires shielded cable and stress cones and 36" transition cabinet.
U02	Version with CE conformity With option U02, a drive version with CE conformity is supplied.
Note:	Drives manufactured in Nuremberg, Germany are supplied with CE conformance
U03	Version with CSA certification With option U03, a drive version certified by the Canadian Standards Association (CSA) is supplied. Option U03 includes option M08 (mechanical door interlocks – Superior).
U04	EAC certificate With option U04, a drive version in conformance with EAC is supplied.

Documentation Options

The standard documentation is supplied in English on CD-ROM. The circuit diagrams / terminal diagrams are available only in English.

If option D00 or one of the options D54 to D95 is ordered, the operating instructions, and safety notes on the drive are delivered according to the ordered language option. This option has to be selected (mandatory option) if the country of the end customer is an EU country. Documentation in all European Union languages is available.

The quality documents (e.g. approval, certificates, etc) and the technical documents (e.g. circuit diagrams, dimensional drawings, etc) are only available in English or German. Supplementary documentation for the components installed in the drive (provided by the manufacturers of these components) is included on the CD-ROM in English/German. For technical reasons, it is not possible to provide this supplementary documentation for only the options that the customer has ordered.

Please contact the factory or your local Siemens sales representative for documentation in a language different from the ones specified below.

On customer request, Siemens will provide documentation in the language required as an option.

Option	Description
D00	Documentation in German With order code D00, the documentation is supplied in German electronically.
D02	Circuit diagrams, terminal diagrams and dimension drawings in DXF format (English only) Documents such as circuit diagrams, terminal diagrams, the arrangement diagram and the dimension drawing can be ordered with order code D02 in DXF format, e.g. for use in AutoCAD systems.
D15	One set of printed documentation If documentation is also required on paper, this must be ordered using order code D15. Multiple quantities are possible
D76	Documentation in English The documentation is supplied in English electronically.
D79	Documentation in Portuguese (Brazil) The documentation is supplied in Portuguese electronically.
D84	Documentation in Chinese The documentation is supplied in Chinese electronically.
Note	The language options D00, D54 to D75 and D77 to D95 are mutually exclusive but can be combined with option D76 as a second documentation language. An additional CD-ROM with documentation in English as second documentation language will be issued. To get printed documentation in English, select option D15.

Production Schedules

The options B43 to B45 provide production schedule documents. These are sent via e-mail as PDF file in English after order clarification.

Option	Description
B43	Production schedule: one issue
B44	Production schedule: updated at 2-week intervals
B45	Production schedule: updated once per month

Customer Approval Drawings

Siemens offers several levels of customer drawings depending on customer needs and requirements. The approval ranges from simple interface drawing approval to complex full drawing approval from the customer. Details of approval would vary by product line and location, please, contact your Siemens representative for more details.

Options that require Customer Specific Input

Option	Description
Y05	<p>Customer-specific nameplate</p> <p>As standard the nameplate shows the rated data of the drive under nominal conditions.</p> <p>If data on the nameplate should be adapted to special ambient conditions (temperature, altitude) or should reflect special load conditions (e.g. derating because of operation at low frequency) the option Y05 must be selected.</p> <p>Information to be supplied:</p> <ul style="list-style-type: none"> – Altitude – Coolant temperature – Rated voltages – Rated current – Rated power
Y10	<p>Circuit diagrams with customer-specific description field</p> <p>The circuit diagrams are given customer-specific headers. The data for the header must be specified in plain text (up to three lines of 45 characters per line).</p>
Y15	<p>Output filter</p> <p>The filter is typically required when cable lengths at the drive output exceed 2.3 km (7500 ft). At such long distances, the effective switching frequency harmonics and sidebands may excite a cable resonance resulting in transmission line overvoltages at the motor terminals.</p> <p>This option may also be used to address EMI or dV/dt requirements. The filter effectively removes all frequency components above 2000Hz in the drive output voltage. Because SINAMICS PERFECT HARMONY GH180 is already free of low-order output harmonics, the result is a nearly perfect sinusoidal output waveform.</p> <p>Depending on the drive configuration, the filter may be located in transition cabinets. The filter components are dimensioned based on the continuous current rating of the power cells and maximum drive voltage.</p> <p>For more detailed information, please contact the factory or your local Siemens sales representative.</p>

Option	Description
Y36	<p>Customer-specific cabinet labels</p> <p>Labels with customer-specific information are attached to the drive cabinets according to Siemens standard. The text and quantity of these labels need to be specified as plain text. As standard, the labels will be manufactured out of Formica, using black letters on a white background.</p>

Output Voltage

Option	Description
V01	2.3 kV Motor Voltage
V02	2.4 kV Motor Voltage
V03	3.0 kV Motor Voltage
V04	3.3 kV Motor Voltage
V05	4.0 kV Motor Voltage
V06	4.16 kV Motor Voltage
V07	4.8 kV Motor Voltage
V08	5.0 kV Motor Voltage
V09	5.5 kV Motor Voltage
V10	6.0 kV Motor Voltage
V11	6.3 kV Motor Voltage
V12	6.6 kV Motor Voltage
V13	6.9 kV Motor Voltage
V14	7.2 kV Motor Voltage
V15	8.0 kV Motor Voltage
V18	10.0 kV Motor Voltage
V 19	11.0 kV Motor Voltage

Extension of liability for defects on drives

Siemens provides customer with the option of extending existing liability for defect periods beyond the standard ones. The liability for defect period listed in our standard terms and conditions is 12 months. The USA factory offers 24 months as a standard. Details and conditions will vary by location. This can be extended as follows:

Option	Description
Q80	12 months extension to a total of 24 months (2 years) from delivery
Q81	18 months extension to a total of 30 months (2½ years) from delivery
Q82	24 months extension to a total of 36 months (3 years) from delivery
Q83	30 months extension to a total of 42 months (3½ years) from delivery
Q84	36 months extension to a total of 48 months (4 years) from delivery
Q85	48 months extension to a total of 60 months (5 years) from delivery

Customer Acceptance Tests

Siemens performs rigorous factory acceptance test on all drives. Additional testing both witnessed and un-witnessed are available, please contact your local SIEMENS sales representative for any questions or inquiries. Below is the example of some of the test available:

Option	Description
F03	Visual acceptance of the drive Open doors/panels; inspection of drive before shipping
F73	Functional acceptance of the drive with inductive load Visual acceptance; functional test with inductive load, cooling system test. Option F73 includes option F03 (visual acceptance).
F77	Acceptance test of the insulation of the drive The following is included in the scope of the acceptance tests: – High-voltage test – The insulation resistance is measured
F79	Interface check with customer equipment (5 hours, on request) For details, please contact the factory or your local Siemens sales representative.
F97	Customer-specific acceptance For details, please contact the factory or your local Siemens sales representative.

Witness Tests

Witness test set up will vary by customer and factory location. Below is an example of witness test offered at our US factory. For details contact Siemens representative.

Witness tests may include:

- A copy of FAT Plan for each attendee. Final certified copies of this data are published approximately two weeks after all testing is completed and shipment has occurred.
- Required PPE (Non-Prescription Safety Glasses with Side shields, Arc Flash retardant clothing, and hearing protection available upon request).
- Customer must provide their own EH rated safety shoes as required per Siemens Safety

Option	Description
F02	Class 1 Witness Test Witnessed testing of a VFD will consist of tests that are part of the Siemens standard FAT defined herein for two (2) attendees – Defined witnessed tests: – Visual inspection and operational overview – Test include the following: <ul style="list-style-type: none"> • Input protection fault simulation • Precharge sequence and fault check (WC) • Motor space heater control (if purchased) • Blower cycling • Loss of flow protection (WC) • Local/Remote control • Emergency Stop local/remote • Motor Logic • Customer control interface (excludes customer supplied equipment) • Thermal sensors • Cell Bypass operation (if purchased) • Spinning load • VFD run (unloaded)
F94	Class 2 Witness Test Witnessed testing of a VFD will consist of tests that are part of the Siemens standard FAT defined herein for five (5) attendees In addition to the test mentioned in Class 1, witness test class 2 offers: <ul style="list-style-type: none"> • Up to 1-hour VFD current run on load reactor at 60Hz
F95	Class 3 Witness Test Witnessed testing of a VFD will consist of tests that are part of the Siemens standard FAT defined herein for up to ten (10) attendees In addition to the test mentioned in Class 1 and 2, witness test class 3 offers: <ul style="list-style-type: none"> • Efficiency, Power Factor and Harmonics tests demonstrated at defined points on an unloaded VFD.

GH180 Water-Cooled Specific Options

Option	Description
E01	Motor static exciter furnished by Siemens For synchronous motor applications the static exciter cabinet will be provided by Siemens as part of the drive lineup with the same degree of protection as the drive.
Note	Consult factory for technical requirements when controlling synchronous motors.

Option	Description
G89	Digital relay contactor control of external auxiliaries This option provides the ability to control the external motor space heaters via digital relay contact. When the motor is not energized the drive activates the space heaters to maintain motor internal air temperature above the dewpoint during shutdown. Water-cooled only option.
Note:	This option requires an additional cabinet

Option	Description
L33	Regenerative Braking For the applications that require intermittent regenerative operation for controlled or quick stop, the drive is equipped with regenerative cells to support this option.
Note:	Available for 880 and 1250A This option does not support continued operation

Option	Description
N02	Interface with customer circuit breaker – DC rated dry contacts These contacts are used for the drive trip signal and the close signal. These relays are rated at 125 V AC 20 A. Minimum 12 V DC 1 A.
N03	Interface with customer circuit breaker – AC rated dry contacts These contacts are used for the drive trip signal and the close signal. These relays are rated at 240 V AC 25 A, 277 V AC 20 A and 600 V AC 10 A. Minimum 12 V AC 1 A.
Note:	Option N02 is a default setting.

Option	Description
M88	Premium Corrosion Protection The water-cooled drive is by design a self-contained configuration, so it is less affected by environmental contamination compared to an air-cooled solution. If the environment requires additional corrosion protection above the standard, the drive incorporates upgraded finishes & hardware to reduce the effects of this environment on the drive components. These additional measures include: <ul style="list-style-type: none"> – Premium anti-corrosion cabinet paint capable of withstanding a maximum salt spray resistance of 5000 hours – Coated printed circuit boards – Plated bus – External stainless steel hardware – Stainless steel gland plates
Note:	This is water-cooled drive option only

Option	Description
P40	Transformer assembly lift points outside on cabinet roof External lift points for overseas transportation are added to reduce potential for damage during overseas ship transportation.

Option	Description
W51	Mechanical two way inlet water temperature regulating valve With option W51 Mechanical On/Off valve is supplied. Mechanical On/Off valve is recommended when cooling water is supplied from well or tap.
W52	Mechanical three way inlet water temperature regulating valve With option W52 mechanical three way valve is supplied. Three way valve is recommended in the following cases: <ul style="list-style-type: none"> – a constant flow is available – water is supplied directly from river or lake – one cooling system for both drive and motor
Note	Option W51 is a default setting.

Option	Description
W71	Siemens provided deionized water Siemens will provide the required amount of deionized water for the inner closed loop cooling system.
W72	Siemens provided propylene glycol Siemens will provide the required amount of glycol for the inner closed loop cooling system.

Option	Description
W04	Advanced Cooling Cabinet Compared to the standard cooling cabinet, this option provides customer additional features and sensors: <ul style="list-style-type: none"> – Advanced control – Additional sensors – Monitoring of expansion tank level of 4 - 20mA sensors - the signal level is available via PLC communication – PLC for monitoring / control – Dual auxiliary voltage feed available for easy installation – Dual deionizer tanks, active & spare, in separate section at front of cabinet – VFD driven pumps – Built in lift system (hoist) for changing pumps – Control of the external water-air heat exchanger: up to 12 external HEX fans cycled in pairs (multi-stage cycling)
Note	This cooling cabinet is 60" (1522mm) wide; it will add 12" (305mm) to the drive length.

Option	Description
W32	Drive prepared for liquid-to-air heat exchanger This option allows drive to operate with glycol in its system. Up to 60% glycol mix is available. The amount of glycol will depend on freezing point of each site. No current derating is required. Drive can be combined with external liquid-to-air heat exchanger.
W35	Liquid-to-air heat exchanger control panel mounted on outside of the coolant cabinet
W05	Coolant cabinet high capacity expansion tank A drive in a system with total volume between 250 - 500 U.S. gallons requires one High Capacity Coolant Expansion Tank.



Example of installation with W32 option: there are 2 WC drives in the building

Option	Description
W55	Prepared for inlet water filter for low-quality water With option W55 an inlet water filter is supplied. The filter protects water-to-water heat exchanger from clogging and fouling. It prevents blockages in the cooling water system by removing debris and marine life. The filter is automatically backflushed at regular intervals to keep it clean. Automatic flushing is carried out at regular intervals without interrupting the filtering process. This filter reduces the need for redundant water-to-water heat exchanger.
Note	It is a drop ship option. Unit will be installed by the customer upstream of heat exchanger and outside of the drive.

Selection and Ordering Data Explanation

	1	2	3	4	5	6	7	-	8	9	10	11	12	-	13	14	15	16	
PERFECT HARMONY GH180	6	S	R	•	•	•	•		•	■	•	•	•		•	■	■	0	
4th Digit: Generation Number																			
Generation 3				3															
Generation 4				4															
Generation 5				5															
Manufacturing location																			
Nuremberg, Germany				1															
Pittsburgh, PA, USA				2															
Shanghai, China				5															
Jundiai, Brazil				6															
Cooling																			
Air-cooled							0												
Water-cooled							7												
Line-side behavior																			
Diode Front End									2										
6-step regen									4										
Rated max. output voltage																			
4.16 kV 3 AC, 9 cells									0										
5.3 kV 3 AC, 12 cells									1										
6.9 kV 3 AC, 15 cells									2										
8.0 kV 3 AC, 18 cells									3										
11.0 kV 3 AC, 24 cells									5										
2.4 kV 3 AC, 9 cells									6										
Primary input voltage																			
2.4 kV 3 AC																			A
3.0 kV 3 AC																			B
3.3 kV 3 AC																			C
4.16 kV 3 AC																			D
4.8 kV 3 AC																			E
6.0 kV 3 AC																			F
6.3 kV 3 AC																			G
6.6 kV 3 AC																			H
6.9 kV 3 AC																			J
7.2 kV 3 AC																			K
8.4 kV 3 AC																			L
10.0 kV 3 AC																			M
11.0 kV 3 AC																			N
12.0 kV 3 AC																			P
12.47 kV 3 AC																			Q
13.2 kV 3 AC																			R
13.8 kV 3 AC																			S
460 V 3 AC ¹⁾																			T
575 V 3 AC ¹⁾																			U

1) Utilization voltages, system voltages are 480V or 600V

Selection and Ordering Data Explanation

	1	2	3	4	5	6	7	-	8	9	10	11	12	-	13	14	15	16
PERFECT HARMONY GH180	6	S	R	•	•	•	•		•	■	•	•	•		•	■	■	0

Cell rating AC

40	A
70	B
100	C
140	D
200	E
260	F
340	G
430	H
500	J
660	K
750	N

Cell rating WC

880 Regenerative breaking only	B
1000	D
1250	C
1375	E

Drive Rating: AC - Transformer Primary kVA; WC - Drive Power (HP)

150	3	1	5
....
800	3	8	0
900	3	8	7
1000	4	1	0
1500	4	1	5
.....
3000	4	3	0
4000	4	4	0
....
9000	4	8	7
10000	5	2	0
....
15000	5	3	0
20000	5	4	0
33000	5	5	8

Transformer configuration

60 Hz, Cu	A
50 Hz, Cu	B
60 Hz, Al	E
50 Hz, Al	F

Auxiliary voltage

380 V 3 AC, 50/60 Hz	F
400 V 3 AC, 50/60 Hz	G
415 V 3 AC, 50/60 Hz	H
460 V 3 AC, 50/60 Hz	J
575 V 3 AC, 50/60 Hz	L

SINAMICS PERFECT HARMONY GH180 Technical Data

General Technical Data

General Technical Data			
Drive quadrants	2 or 4		
Isolation	Fiber optic cable		
Rated Efficiency	Cu	Typical 97.0 % including transformer, 96.5% guaranteed across whole product range	
	Al	Typical 96.5 % including transformer, 96% guaranteed across whole product range	
Regulation compliances	IEEE, ANSI, NEMA, UL, CSA, CE		
Cooling	6SR5 Series		6SR4 Series
	Air-cooled		Water-cooled
Degree of Protection ¹⁾	NEMA 1/ IP42 (standard)		NEMA 12/ IP54 (standard)
Altitude	Ft (m)	0...3,300 (1,000) standard, Up to 14,763 (4,500) with de-rating	

Sound Pressure Level at 3ft (1m)		6SR5	6SR5	6SR5	6SR5	6SR4	6SR4	6SR327
		40-70A	100-140A	200-260A	340-430A	315-375A	500-750A	880-1375A
9 cell configuration	dBa	75	80	82	82		80	76
12 cell configuration	dBa	80	80	80	82		80	76
15 cell configuration	dBa	80	80	80		80	80	76
18 cell configuration	dBa						80	76
24 cell configuration	dBa							76

Power Cabling Cross Sections ²⁾		6SR5	6SR5	6SR5	6SR5	6SR5	6SR4	6SR327
		40-70A	100-140A	200-260A	315-375A	340-430A	500-750A	880-1375A
Line-side, max. connectable per phase with M10 (M08 for 40-70A) screw preliminary	AWG/MCM (NEC, CEC)	1 x 350 MCM	1 x 4/0 AWG	1 x 500 MCM 2 x 2/0 AWG	2 x 500 MCM	2 x 500 MCM	2 x 1000 MCM	2 x 1000 MCM
	mm ² (DIN VDE)	1 x 185	1 x 95	1 x 240 2 x 70	2 x 240	2 x 240	2 x 500	2 x 500
Motor-side, max. connectable per phase with M10 (M08 for 40-70A) screw preliminary	AWG/MCM (NEC, CEC)	1 x #2 AWG	1 x 2/0 AWG	1 x 4/0 AWG	1 x 500 MCM	1 x 500 MCM	2 x 1000 MCM	2 x 1000 MCM
	mm ² (DIN VDE)	1 x 35	1 x 70	1 x 95	1 x 240	1 x 240	2 x 500	2 x 500
PE (protective earth) connection, max. connection cross-section at enclosure with M12 screw preliminary	AWG/MCM (NEC, CEC)	2/0 AWG	2/0 AWG	2/0 AWG	2/0 AWG	2/0 AWG	1000 MCM	2 x 1000 MCM
	mm ² (DIN VDE)	70	70	70	70	70	500	2 x 500

1) According to IEC 60529

2) Maximum installable size per phase, shielded cables

Cell Overload Capability

	6SR5								6SR4					6SR327			
	40	70	100	140	200	260	340	430	315	375	500	660	750	880	1000	1250	1375
Cell Rating	40	70	100	140	200	260	340	430	315	375	500	660	750	880	1000	1250	1375
Maximum cell continuous current	44	77	110	154	220	286	374	473	346	412	550	726	750	880	1000	1250	1375
110% Overload (1min/ 10min)	40	70	100	140	200	260	340	430	315	375	500	660	682	880	909	1250	1250
150% Overload (1min/ 10min)	29	51	73	103	147	191	249	315	231	275	367	484	500	667	667	917	917

Auxiliary Supply

Configuration		Control Voltage			
		Three Phase			Single Phase
		380 V	460 V	575 V	120 V
6SR5 40-70A K79 ¹⁾	A	2.0	2.5	2.0	4.0
6SR5 40-70A K69 ²⁾	A	3.5	4.0	3.0	
6SR5 100-140A K79 ¹⁾	A	3.5	4.0	3.5	4.0
6SR5 100-140A K69 ²⁾	A	5.0	5.5	4.5	
6SR5 200-260A K79 ¹⁾	A	6.5	8.0	6.5	4.0
6SR5 200-260A K69 ²⁾	A	8.0	9.5	7.5	
6SR5 340-430A K79 ¹⁾	A	10.0	11.5	9.5	4.0
6SR5 340-430A K69 ²⁾	A	11.5	12.5	10.5	
6SR4 500-750A K79 ¹⁾ 9/12 cell up to 4000 Hp	A	12.5	11.5	9.0	4.5
6SR4 500-750A K69 ²⁾ 9/12 cell up to 4000 Hp	A	15.0	13.5	11.0	
6SR4 500-750A K79 ¹⁾ 9/12 cell 4500 to 6000 Hp	A	15.5	14.5	11.5	4.5
6SR4 500-750A K69 ²⁾ 9/12 cell 4500 to 6000 Hp	A	18.5	16.5	13.0	
6SR4 500-750A K79 ¹⁾ 15/18 cell up to 4000 Hp	A	15.5	14.5	11.5	4.5
6SR4 500-750A K69 ²⁾ 15/18 cell up to 4000 Hp	A	18.5	16.5	13.0	
6SR4 500-750A K79 ¹⁾ 15/18 cell 4500 to 6000 Hp	A	18.5	17.0	13.5	4.5
6SR4 500-750A K69 ²⁾ 15/18 cell 4500 to 6000 Hp	A	21.5	19.0	15.5	
6SR4 500-750A K79 ¹⁾ 15/18 cell 6500-8000 Hp	A	18.5	17.0	13.5	4.5
6SR4 500-750A K69 ²⁾ 15/18 cell 6500-8000 Hp	A	21.5	19.0	15.5	
6SR4 500-750A K79 ¹⁾ 15/18 cell 9000 Hp	A	18.5	20.0	16.0	4.5
6SR4 500-750A K69 ²⁾ 15/18 cell 9000 Hp	A	20.0	21.0	17.0	

- 1) Single phase for NXG control
- 2) K69 includes CPT: Control power transformer
- 3) Includes cooling blowers; largest unit shown.
- 4) Drive space heater option (L55) requires separate source

Configuration		Control Voltage			
		Three Phase			Single Phase
		380 V	460 V	575 V	120 V
6SR327 K69 ¹⁾ with CPT	A	1.6	1.3	1.1	
6SR327 K69 with CPT and W04 option	A	3.2	2.6	2.2	
6SR327 880-1375A 9 cell K79 ²⁾	A	13.4	8.4	6.8	5.0
6SR327 880-1375A 9 cell K79 ²⁾ and W04 ³⁾	A	33.1	27.2	21.4	10.0
6SR327 880-1375A 12 cell K79 ²⁾	A	14.6	12.7	10.1	5.0
6SR327 880-1375A 12 cell K79 ²⁾ and W04 ³⁾	A	34.3	28.4	22.3	10.0
6SR327 880-1375A 15 cell K79 ²⁾	A	19.4	16.9	13.5	5.0
6SR327 880-1375A 15 cell K79 ²⁾ and W04 ⁴⁾	A	35.5	29.6	23.3	10.0
6SR327 880-1375A 18 cell K79 ²⁾	A	20.6	18.1	14.5	5.0
6SR327 880-1375A 18 cell K79 ²⁾ and W04 ³⁾	A	36.7	30.8	24.3	10.0
6SR327 880-1375A 24 cell K79 ²⁾	A	30.4	26.5	21.2	5.0
6SR327 880-1375A 24 cell K79 ²⁾ and W04 ³⁾	A	39.1	33.2	26.2	10.0
System pre-charge ⁴⁾	%	0.5	0.5	0.5	

- 1) K69 includes CPT (Control power transformer) current requirements, for full current requirement, with or without W04 for total A required for K69 Option
- 2) Single phase for NXG control and 120 V AC internal heat exchanger in water-cooled systems
- 3) Includes cooling pumps; largest unit shown.
- 4) Percentage of transformer kVA

Note: Options A30, A82, A83, and E04 will require slightly more current from the 120V source.

If either the Option Cabinet or the Exciter Cabinet (E01) are present, an additional 2.1 Amps will be required per cabinet.

Storage, Transportation and Operation Data

		Storage	Transport	Operation
Ambient conditions				
Ambient temperature	°C	+5 to +40 ¹⁾	-25 to +60 ¹⁾	+5 to +40 ²⁾ +5 to +50 ³⁾ -45 to +45
Outdoor Type 4				
Relative air humidity		< 95 % (only slight condensation permitted; drive must be completely dry before commissioning)	< 95 % (only slight condensation permitted; drive must be completely dry before commissioning)	< 95 % (condensation not permitted)
Other climatic conditions in accordance with class		1K3, 1Z2 in acc. with IEC 60721-3-1	2K2 in acc. with IEC 60721-3-2	3K3 in acc. with IEC 60721-3-3
Degree of pollution		2 without conductive pollution in acc. with IEC 61800-5	2 without conductive pollution in acc. with IEC 61800-5	2 without conductive pollution in acc. with IEC 61800-5
Stationary vibration, sinusoidal				
• Displacement	Mm	1.5 (2 to 9 Hz)	3.5 (2 to 9 Hz)	0.3 (2 to 9 Hz)
• Acceleration	m/s m/s	5 (9 to 200 Hz)	10 (9 to 200 Hz) 15 (200 to 500 Hz)	1 (9 to 200 Hz)
Other mechanical conditions in accordance with class		1M2 in acc. with IEC 60721-3-1	2M2 in acc. with IEC 60721-3-2 ⁴⁾	3M1 in acc. with IEC 60721-3-3
Other ambient conditions				
Biological ambient conditions in accordance with class		1B1 in acc. with IEC 60721-3-1	2B1 in acc. with IEC 60721-3-2	3B1 in acc. with IEC 60721-3-3
Chemical active substances in accordance with class		1C1 in acc. with IEC 60721-3-1	2C1 in acc. with IEC 60721-3-2	3C2 in acc. with IEC 60721-3-3
Mechanical active substances in accordance with class		1S1 in acc. with IEC 60721-3-1	2S1 in acc. with IEC 60721-3-2	3S1 (with optional NEMA 12/IP54 LV enclosures) in acc. with IEC 60721-3-3

- 1) For water-cooled drives: no cooling water in system
- 2) For water-cooled drive: maximum 40°C drive ambient air temperature with maximum 47° C drive inlet water temperature
- 3) 50C is available with current derating for air-cooled drives; water-cooled drives - maximum 50°C drive ambient air temperature with maximum 40° C drive inlet water temperature
- 4) Siemens equipment meets all 2M2 conditions except free fall and pitch and roll

SINAMICS Perfect Harmony GH180 Control Performance

Speed and torque control

Feature	V/Hz control	Open-loop vector control	Closed-loop vector control
Speed range (for 100% torque and 150% starting torque)	40:1	100:1	200:1
Torque regulation (% of rated)	n/a	± 2 %	± 2 %
Torque linearity (% of rated)	n/a	± 5 %	< ± 5 %
Torque response ¹⁾	n/a	> 750 rad/s	> 750 rad/s
Speed regulation (% of rated)	Motor slip	± 0.5 % ²⁾	± 0.1 % ^{3,4)}
Speed response ⁵⁾	20 rad/s	20 rad/s	> 20 rad/s ⁶⁾

- 1) Torque response values are valid for drive without an output filter. Tuning may be required to achieve these values.
- 2) Approx. 0.3 % speed error is typical. Worst-case speed error is equal to approximately 30 % of rated motor slip.
- 3) 0.1 % can be achieved with a 1024 PPR encoder. Speed accuracy depends on the encoder PPR.
- 4) For specific applications, 0.01% accuracy can be achieved - consult factory
- 5) Speed response numbers apply as long as torque limit is not reached.
- 6) Testing is required to determine exact value.

Note: Applications that require lower than 1% speed operation under high load torque should use the CLVC mode. In such cases it is preferable to select a motor that has high full-load slip (>1.0 %) and high breakdown torque.

Voltage Sag, Undervoltage Conditions and Interruptions Performance

At full speed, SINAMICS Perfect Harmony GH180 provides regular operation for dips down to 90% of nominal voltage. After that the drive output power is rolled-back linearly from 100% power at 90% of input voltage down to 50% power at 66% of nominal input voltage. Output power is reduced by limiting the available motor torque. The SINAMICS Perfect Harmony GH180 can operate continuously in this mode.

When the input voltage falls below 66%, then the power is quickly reduced to a slightly negative value (regenerative limit) (figure 22). This limit forces the drive to absorb power from the motor and maintain the DC bus voltages in case the input voltage recovers during medium voltage ride-through. The limit is implemented as an inverse function of speed in order to maintain constant power flow to the DC-bus.

When the input voltage falls below 66% (or other limit defined by manufacturer), the SINAMICS Perfect Harmony

GH180 will ride-through without tripping up to 500 milliseconds with all cells functioning and 100 milliseconds with cells in bypass. During ride-through the motor voltage is maintained but no torque is produced until the input voltage is re-established. The drive provides only magnetizing current to a motor leaving energy stored in the DC link to generate output voltage. Automatic restart into spinning load is possible with no load or line disturbance as long as the motor flux is present.

SINAMICS Perfect Harmony GH180 requires a separate low voltage input for control and auxiliaries provided by the customer that is typically backed up by UPS. In the case where a UPS is not available SINAMICS Perfect Harmony GH180 has the option to incorporate a UPS into the drive design to ensure smooth performance during voltage sag and undervoltage conditions for low voltage network. Without UPS, SINAMICS Perfect Harmony GH180 control ride-through is 5 cycles.

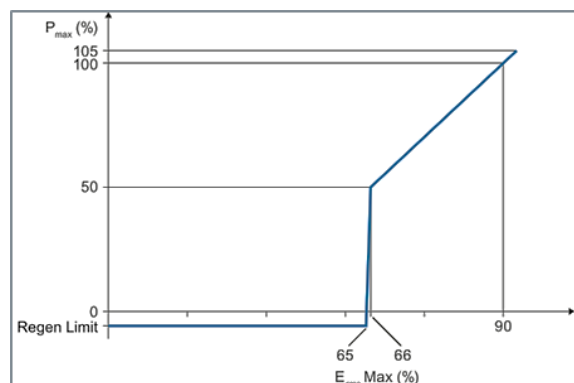

Fig.22 Drive Power (Pmax) as a Function of Input Voltage Magnitude (Erms)

NXGPro ToolSuite

The NXGPro ToolSuite is a PC-based high-level Graphical User Interface application that integrates various software tools used for NXGPro based drives. ToolSuite, equipped with the Microsoft Windows Operating System, allows navigation through a drive's features by using a PC or by using a touch-screen allowing customer to monitor and control drive's functions quickly and easily. ToolSuite contains the following tools: Drive Tool, Debug Tool, and SOP Utilities.

Configuration

- Multilevel password to limit access: the same password used as in drive
- Folders for each drive configuration category (i.e., VFD Menu system)
 - Icon colors to indicate default and modified parameter values
 - On screen parameter identifier (matches operator panel IDs for speed menus)
 - Parameter editing assisted by minimum/maximum limits and defaults
- Ability to upload logs, parameters, system program
- Ability to download system program and/or configuration data files

Graphing

- Adjustable time scale
- Predefined variable list to select variable to be graphed
- Graph up to 10 variables
- Individual variable offsets
- Customizable graphics: fonts, color, styles
- Freeze graphics
- Freeze graph on fault
- Freeze on selectable trigger
- Zoom graph
- Printable and exportable graphics

Status

- Programmable display variables
- Pick list selectable variables, same as drive operator panel display list. The drive control provides the capability to monitor up to 64 different drive and motor parameters according to customer application and specification. They can be selected from more than 200 parameters and variables available in the system. The table below shows some of the parameters available.
- First 4 synchronized to operator panel display
- Fault and alarm indicators (traffic lights: red = fault, yellow = alarm, green = none)

Drive Tool

Its purpose is to manage all of the drive features and provide the user with a user-friendly view of the drive. The Drive Tool's main features include:

- Drive configuration
- Drive variable graphing
- Drive status (provides real time status of various parameters, measured values, and calculations)

Debug Tool

This application provides a remote graphical user interface for Siemens medium-voltage SINAMICS PERFECT HARMONY GH180 NXGPro series drives. With the Debug Tool, the user can examine drive variables using a PC in a simple and quick manner. The debug utility is intended for use during test, commissioning, and troubleshooting of the drive.

SOP Utilities

The System Operating Program (SOP) is the logic that maps the internal and external I/O into the functionality of the drive. In its simplest form, it just maps internal states to external points. It performs most of the functionality on the PC running the ToolSuite, it also offers serial communications capability for uploading and downloading the System Program directly to the drive via an Ethernet interface between the drive and the PC.

Input parameters	Motor parameters	Drive parameters
Input voltage	Output power (kW)	Transformer overload
Input voltage harmonics (one at a time)	Output power kW-Hr	VFD efficiency
Input current	Output current – RMS	Drive State
Input current harmonics (one at a time)	Output voltage – RMS	Drive Internal Losses
Input power factor	Motor torque	Power Cell Status
Input power (kW)	Motor speed (RPM)	Bypass status
Input reactive power (kVAR)	Motor slip (%)	Auxiliary Demand
Input kW-Hr	Drive output frequency (Hz)	Output of energy saver
Input phase sequence	Magnetizing current	High starting torque mode state
Loss of phase	Torque current	Drive neutral voltage
Low voltage	Motor flux	Max available output voltage
	Stator resistance	Synchronous transfer state
	Full load speed	Critical speed avoidance output

Protection and Monitoring Functions

Vector control	The drive can be controlled by means of vector control algorithm without an encoder: open-loop control (standard) or with it: closed-loop control (option).
Auto tuning	Auto tuning is available to optimize the control performance of the drive.
Automatic restart	Automatic restart is a custom feature used to purposely restart and restore the drive operation after a power failure or power removal. When Automatic Restart function is specified by the customer, qualified Siemens personnel must configure and ensure the function executes as specified.
Energy saver	<p>Energy saver control allows the reduction of motor losses, and improves overall efficiency, when the demanded motor load is low. Depending on the motor load, the control will reduce motor flux.</p> <p>As motor load increases, the control will increase motor flux.</p>
Flying restart	The flying restart function permits smooth connection of the drive to a rotating motor.
Diagnostics functions	<ul style="list-style-type: none"> • Self-diagnosis of control hardware • Non-volatile memory for reliable diagnosis when the power supply fails • Monitoring of IGBTs with individual messages for each cell • User-friendly local operator panel with plain text messages • The alarm/fault log consists of a circular buffer that records up to 256 faults or alarms, so that customer can access the most recent faults and/or alarms that have been detected • The historic log records operating data of the drive and is frozen upon detection of a fault
User configurable digital meters	The user can select indication of speed, voltage, current, input/output power, and efficiency on the operator panel.
Operating hours and switching cycle counter	<p>The amount of time that the drive was operational since it was commissioned can be displayed.</p> <p>The switching cycle counter can be generated by means of an event log from the drive controller.</p>
Detection of actual motor speed	The control algorithm calculates actual motor speed from currents and voltages measured at the drive output.
Emergency stop button	The drives are equipped as standard with an Emergency Stop button (red mushroom button with yellow collar) which is fitted in the cabinet door. The contacts of the pushbutton are connected in parallel to the terminal block so they can be integrated in a protection concept on the plant side.
Insulation monitoring	An optional output signal can be provided to operate the customer protection.
I/O monitoring	I/O signals allow user customization of the system and they can be monitored remotely or by using the operator panel display.
Thermal overload protection	Based on the output signals of the drive, the thermal motor model is calculated. The motor thermal overload protection algorithm prevents the motor from being exposed to excessive temperatures.

SINAMICS Perfect Harmony GH180 Air-Cooled Technical Data

SINAMICS Perfect Harmony GH180 6SR5 40-430A and 6SR4 500-750A Parameters

6SR5 40-430 and 6SR4 500-750A 2.4 kV Motor Voltage, 9 Cell Configuration

Drive Series	Shaft Output ¹⁾		Motor Current ¹⁾ A	Cell Rating A	Dimensions ^{2,3)} WxHxD			Weight	
	Hp	kW			in	mm		lb	kg
6SR5.020.A315..0	150	112	32	40	48x102x40	1219x2591x1016	A	3600	1633
6SR5.020.B320..0	200	149	43	70				3700	1678
6SR5.020.B330..0	300	224	65	70				4100	1860
6SR5.020.C340..0	400	298	87	100	60x110x42	1524x2782x1067	B	4900	2223
6SR5.020.D350..0	500	373	108	140				5100	2313
6SR5.020.D360..0	600	448	130	140				5500	2495
6SR5.020.D370..0	700	481	140	140				5800	2631
6SR5.020.E380..0	800	597	169	200	75x110x45	1905x2782x1143	C	5900	2676
6SR5.020.E387..0	900	671	190	200				6400	2903
6SR5.020.F410..0	1000	746	212	260				6900	3130
6SR5.020.G412..0	1250	932	268	340	134x116x48	3400x2936x1200	E	11377	5171
6SR5.020.G415..0	1500	1118	321	340				11877	5399
6SR5.020.H417..0	1750	1306	370	430				12377	5613
6SR5.020.H420..0	2000	1492	423	430				12877	5841
6SR4.020.J422..0	2250	1679	476	500	188x118x50	4775x2972x1270	G	26800	12156
6SR4.020.K425..0	2500	1865	529	660				26800	12156
6SR4.020.K430..0	3000	2235	643	660				26800	12156
6SR4.020.N435..0	3500	2497	750	750				26800	12156

6SR5 40-430A and 6SR4 500-750A 3.3 kV Motor Voltage, 9 Cell Configuration

Drive Series	Shaft Output ¹⁾		Motor Current ¹⁾ A	Cell Rating A	Dimensions ^{2,3)} WxHxD			Weight	
	Hp	kW			in	mm		lb	kg
6SR5.020.A315..0	150	112	24	40	48x102x40	1219x2591x1016	A	3600	1633
6SR5.020.A320..0	200	149	31	40				3700	1678
6SR5.020.B330..0	300	224	47	70				4100	1860
6SR5.020.B340..0	400	298	62	70	60x110x42	1524x2782x1067	B	4400	1996
6SR5.020.C350..0	500	373	78	100				5100	2313
6SR5.020.C360..0	600	448	94	100				5500	2495
6SR5.020.D370..0	700	481	109	140				5800	2631
6SR5.020.D380..0	800	597	125	140	75x110x45	1905x2782x1143	C	6100	2676
6SR5.020.E387..0	900	671	141	200				6400	2903
6SR5.020.E410..0	1000	746	156	200				6900	3130
6SR5.020.E412..0	1250	932	195	200	134x116x50	3400x2936x1274	E	8100	3831
6SR5.020.F415..0	1500	1118	234	260				9300	4218
6SR5.020.G417..0	1750	1306	273	340				12377	5613
6SR5.020.G420..0	2000	1492	312	340				12877	5841
6SR5.020.H422..0	2250	1679	351	430	188x118x50	4775x2972x1270	G	13377	6068
6SR5.020.H425..0	2500	1865	390	430				14377	6521
6SR4.020.J430..0	3000	2235	467	500				26800	12156
6SR4.020.K400..0	4000	2984	624	660	26800	12156			

- 1) The typical motor current and the power data are approximate values only; these have been calculated for operation with induction motors and for typical power factor $\cos \phi$ of 88% and motor efficiency of 95.2%
- 2) Height includes blower cage; 40-70A configuration blowers are part of a cabinet, other configurations blowers are removed for shipping. Certain options will change drive dimensions, for more details see outline page
- 3) Outline Drawing number

6SR5 40-430A and 6SR4 500-750A 4.16 kV Motor Voltage, 9 Cell Configuration

Drive Series	Shaft Output ¹⁾		Motor Current ¹⁾ A	Cell Rating A	Dimensions ^{2,3)} WxHxD			Weight	
	Hp	kW			in	mm		lb	kg
6SR5.020.A315..0	150	112	32	40	48x102x40	1219x2591x1016	A	3600	1633
6SR5.020.A320..0	200	149	26	40				3700	1678
6SR5.020.A330..0	300	224	39	40				4100	1860
6SR5.020.B340..0	400	298	52	70				4400	1996
6SR5.020.B350..0	500	373	65	70				4700	2132
6SR5.020.C360..0	600	448	78	100	60x110x42	1524x2782x1067	B	5500	2495
6SR5.020.C370..0	700	522	91	100				5800	2631
6SR5.020.D380..0	800	597	104	140				6100	2767
6SR5.020.D387..0	900	671	117	140				6400	2903
6SR5.020.D410..0	1000	746	130	140				6500	2948
6SR5.020.E412..0	1250	933	159	200	75x110x45	1905x2782x1143	C	8100	3674
6SR5.020.E415..0	1500	1119	190	200				9300	4218
6SR5.020.F417..0	1750	1306	222	260				10500	4763
6SR5.020.F420..0	2000	1492	254	260				11800	5352
6SR5.020.G422..0	2250	1679	275	340				134x116x50	3400x2936x1274
6SR5.020.G425..0	2500	1865	305	340	14377	6521			
6SR5.020.H430..0	3000	2238	366	430	15377	6975			
6SR5.020.H435..0	3500	2611	427	430	16377	7429			
6SR4.020.J440..0	4000	2984	488	500	188x115x50	4775x2921x1270	G		
6SR4.020.K450..0	5000	3730	610	660	212x115x50	5385x2921x1270	G	31700	14379
6SR4.020.N460..0	6000	4401	750	750				31700	14379

6SR5 40-260A and 6SR4 315-750A 4.8 kV Motor Voltage, 12 Cell Configuration

Drive Series	Shaft Output ¹⁾		Motor Current ¹⁾ A	Cell Rating A	Dimensions ^{2,3)} WxHxD			Weight	
	Hp	kW			in	mm		lb	kg
6SR5.021.A330..0	300	224	33	40	114x116x42	2900x2936x1065	D	5725	2597
6SR5.021.B340..0	400	298	43	70				6054	2746
6SR5.021.B350..0	500	373	54	70				6382	2895
6SR5.021.B360..0	600	448	65	70				6711	3044
6SR5.021.C370..0	700	522	76	100				7145	3241
6SR5.021.C380..0	800	597	87	100				7474	3390
6SR5.021.C387..0	900	671	98	100				7802	3539
6SR5.021.D410..0	1000	746	108	140				8184	3712
6SR5.021.D412..0	1250	933	136	140				9004	4084
6SR5.021.E415..0	1500	1119	159	200				134x116x50	3400x2936x1274
6SR5.021.E417..0	1750	1306	185	200	11202	5081			
6SR5.021.F420..0	2000	1492	212	260	12399	5624			
6SR5.021.F422..0	2250	1679	238	260	12989	5892			
6SR4.021.G425..0	2500	1865	264	315	150x130x50	3810x3302x1270	F		
6SR4.021.H430..0	3000	2238	317	375				19565	8874
6SR4.021.J440..0	4000	2984	423	500	208x115x50	5283x2924x1270	G	28800	13064
6SR4.021.K450..0	5000	3730	529	660	232x123x50	5893x3124x1270	G	33700	15286
6SR4.021.K460..0	6000	4443	630	660				33700	15286
6SR4.021.N470..0	7000	5219	750	750				33700	15286

- 1) The typical motor current and the power data are approximate values only; these have been calculated for operation with induction motors and for typical power factor $\cos \phi$ of 88% and motor efficiency of 95.2%
- 2) Height includes blower cage; 40-70A configuration blowers are part of a cabinet and can not be split for shipping, other configurations blowers are removed for shipping. Certain options will change drive dimensions, for more details see outline page
- 3) Outline Drawing number

6SR5 40-260A and 6SR4 315-750A 6.6/6.9 kV Motor Voltage, 15 Cell Configuration

Drive Series	Shaft Output ¹⁾		Motor Current ¹⁾	Cell Rating	Dimensions ^{2,3)} WxHxD			Weight	
	Hp	kW			in	mm		lb	kg
6SR5.022.A330..0	300	223	24	40	114x116x42	2900x2936x1065	D	5540	2520
6SR5.022.A340..0	400	298	31	40				5900	2680
6SR5.022.A350..0	500	372	39	40				6230	2830
6SR5.022.B360..0	600	450	47	70				6560	2980
6SR5.022.B370..0	700	521	55	70				6890	3130
6SR5.022.B380..0	800	600	62	70				7220	3280
6SR5.022.C387..0	900	671	70	100				7550	3430
6SR5.022.C410..0	1000	746	78	100				7900	3590
6SR5.022.C412..0	1250	932	98	100				9550	4340
6SR5.022.D415..0	1500	1120	117	140				10380	4720
6SR5.022.D417..0	1750	1304	136	140	11750	5340			
6SR5.022.E420..0	2000	1492	154	200	134x116x50	3400x2936x1274	E	12320	5600
6SR5.022.E422..0	2250	1679	173	200				12890	5860
6SR5.022.E425..0	2500	1865	192	200				13460	6120
6SR5.022.E427..0	2750	2051	200	200				14060	6390
6SR5.022.F430..0	3000	2238	231	260				14630	6650
6SR5.022.G435..0	3500	2600	296	315	164x118x49	4366x2990x1250	G	17460	8000
6SR4.022.H440..0	4000	2984	338	375	172x118x49	4165x2990x1250		18740	8500
6SR4.022.H445..0	4500	2984	338	375				20070	9100
6SR4.022.J450..0	5000	3730	385	500	272x128x54	6909x3251x1372	G	36900	16738
6SR4.022.J460..0	6000	4476	462	500				36900	16738
6SR4.022.K470..0	7000	5222	539	660				36900	16738
6SR4.022.K480..0	8000	5968	623	660				36900	16738
6SR4.022.N487..0	9000	6714	701	750				282x144x54	7263x3658x1372

6SR4 500-750A 7.2kV Motor Voltage, 18 Cell Configuration

Drive Series	Shaft Output ¹⁾		Motor Current ¹⁾	Cell Rating	Dimensions ^{2,3)} WxHxD			Weight	
	Hp	kW			in	mm		lb	kg
6SR4.023.J435..0	3500	2611	269	500	248x120x54	6299x3048x1372	G	32900	14923
6SR4.023.J440..0	4000	2984	308	500				32900	14923
6SR4.023.J450..0	5000	3730	385	500	272x128x54	6909x3251x1372	G	37800	17146
6SR4.023.J460..0	6000	4476	462	500				37800	17146
6SR4.023.K470..0	7000	5222	539	660				37800	17146
6SR4.023.K480..0	8000	5958	615	660				37800	17146
6SR4.023.K487..0	9000	6714	643	660	282x144x54	7263x3658x1372	G	46800	21228

- 1) The typical motor current and the power data are approximate values only; these have been calculated for operation with induction motors and for typical power factor $\cos \phi$ of 88% and motor efficiency of 95.2%
- 2) Height includes blower cage; 40-70A configuration blowers are part of a cabinet, other configurations blowers are removed for shipping. Certain options will change drive dimensions, for more details see outline page
- 3) Outline Drawing number

SINAMICS Perfect Harmony GH180 6SR5 40-260A Outdoor Duty Drive Parameters

2.4 kV Motor Voltage, 9 Cell Configuration

Drive Series	Shaft Output ¹⁾		Motor Current ¹⁾ A	Cell Rating A	Dimensions ^{2,3)} WxHxD			Weight ⁴⁾	
	Hp	kW			in	mm		lb	kg
6SR52020.A315..0	150	112	32	40	103x89x77	2604x2248x1956	I	6600	3016
6SR52020.B320..0	200	149	43	70				6800	3085
6SR52020.B330..0	300	224	65	70				7000	3175
6SR52020.C340..0	400	298	87	100	116x90x76	2954x2286x1936	J	8200	3719
6SR52020.D350..0	500	373	108	140				8500	3856
6SR52020.D360..0	600	448	130	140				8800	3992
6SR52020.D370..0	700	481	140	140				9100	4128

4.16 kV Motor Voltage, 9 Cell Configuration

Drive Series	Shaft Output ¹⁾		Motor Current ¹⁾ A	Cell Rating A	Dimensions ^{2,3)} WxHxD			Weight ³⁾	
	Hp	kW			in	mm		lb	kg
6SR52020.A315..0	150	112	32	40	103x89x77	2604x2248x1956	I	6600	3016
6SR52020.A320..0	200	149	26	40				6800	3085
6SR52020.A330..0	300	224	39	40				7000	3175
6SR5.020.B340..0	400	298	52	70				7250	3289
6SR52020.B350..0	500	373	65	70				7400	3357
6SR52020.C360..0	600	448	78	100	116x90x76	2954x2286x1936	J	8800	3992
6SR52020.C370..0	700	522	91	100				9100	4128
6SR52020.D380..0	800	597	104	140				9500	4309
6SR52020.D387..0	900	671	117	140				9800	4445
6SR52020.D410..0	1000	746	130	140				10000	4536

- 1) The typical motor current and the power data are approximate values only; these have been calculated for operation with induction motors and for typical power factor $\cos \phi$ of 88% and motor efficiency of 95.2%
- 2) Shipping height is 91" (2311 mm) including eyebolts for lifting for 40-70A drive and 93.9" (2385 mm) for 100-140A
- 3) Outline Drawing number
- 4) Redundant blower: Add 60 lbs (27.2 kg); Output Reactor: add 400lb (182 kg)

Air-cooled Dimension Drawings



6SR5 Outdoor duty 9 cell 40-70A
Drawing I

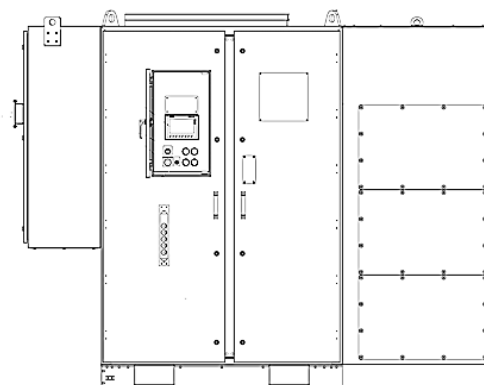

6SR5 Outdoor duty 9 cell 100-140A
Drawing J

Air-cooled Dimension Drawings

Drawings below represent standard GH180 air-cooled drive layouts. Transformers are at the bottom of the cabinet and cells are located in the upper portion of the cabinet. The control section can be either part of the same cabinet or located in the separate cabinet like the SINAMICS Perfect Harmony GH180 12/15 cell 40-260A and GH180 315-375A configurations. SINAMICS Perfect Harmony GH180 500-750A is the only design with side by side configuration: transformer cabinet, followed by control cabinet and cell cabinet. The only difference will be number of cells defined by the output voltage or option code.

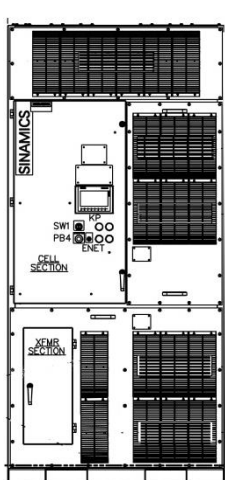

6SR5 9 cell 40-70A
Drawing A

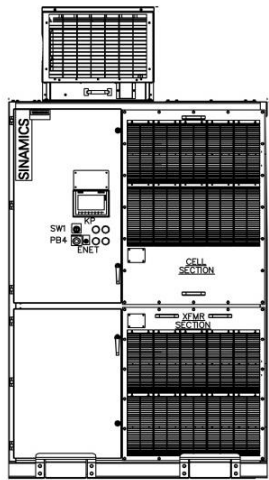

6SR5 9 cell 100-140A
Drawing B

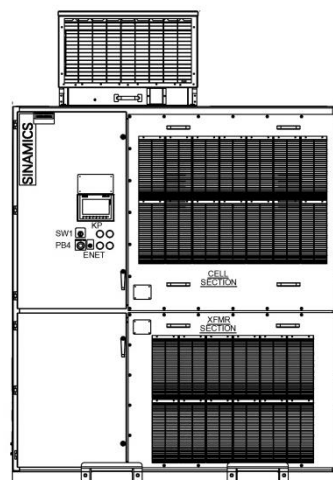

6SR5 9 cell 200-260A
Drawing C

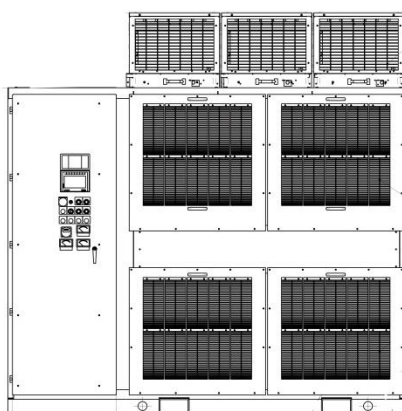

6SR5 12/15 cell 40-140A
Drawing D

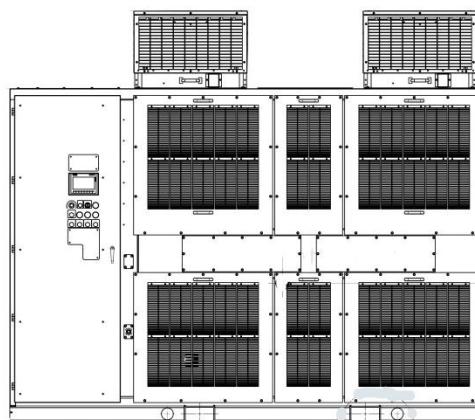

6SR5 12/15 cell 200-260A and 9 cell 340-430A
Drawing E

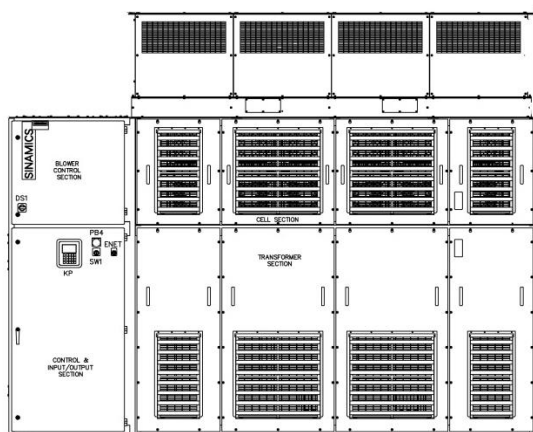

6SR4 12 cell 315-375A
Drawing F

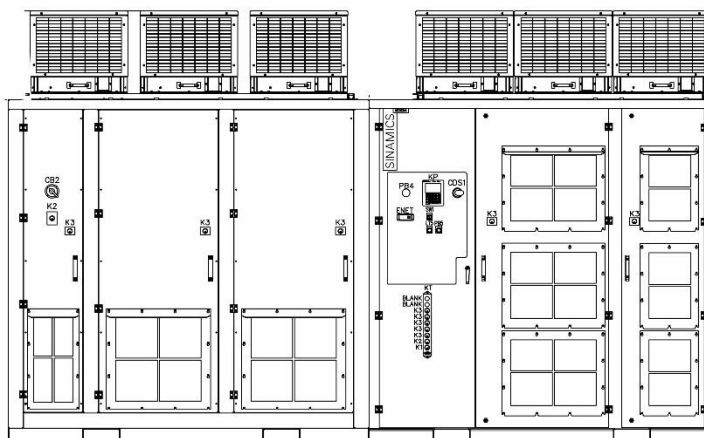

6SR4 9/12/15/18 cell 500-750A and 315-375A 15 cell
Drawing G

Air-cooled Dimension Drawings with Options

There are options that will impact the dimensions of the SINAMICS Perfect Harmony GH180 AC 9 cell configuration drive as well as GH180 air-cooled 500-750A configurations. The list of options for 9 cell 40-260A configuration is:

- N44 make-proof grounding switch at the drive input
- N45 make-proof grounding switch at the drive output
- A30 touchscreen with standard cable (HMI)
- K20 signal lamp in the cabinet door
- K21 display instruments for voltage, current and speed
- E04 additional customer analog, digital inputs and outputs (I/O) modules
- L50 cabinet lighting and service socket outlet
- A82 SEL 710 motor protection relay standalone option
- A83 multilin 869 motor protection relay standalone option
- Input voltage greater than 7.2kV: 8.4kV to 13.8kV input voltage
- Low voltage input 460V for 300HP and above
- Low voltage input 575V for 400Hp and above

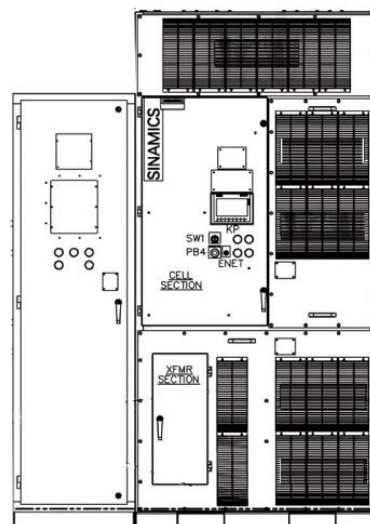

6SR5 9 cell 40-70A Drawing with option cabinet
(example only 100-140 and 200--260A cabinets will be bigger)

GH180 500-660A will require 36" input cabinet for input voltage greater than 5kV

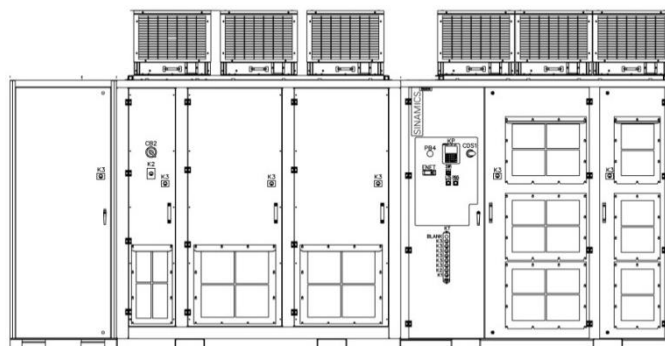

6SR4 9 cell 500-750A
Drawing with input cabinet for input voltage greater than 5 kV

SINAMICS Perfect Harmony GH180 Water-cooled Technical Data

6SR327 3.3 kV Motor Voltage, 9 Cell Configuration

Drive Series	Shaft Output ¹⁾		Motor Current ¹⁾	Cell Rating	Dimensions ^{2,3)} WxHxD		Weight		
	Hp	kW	A	A	in	mm	lb	kg	
6SR32720.D440..0	4000	2984	623	1000	305x115x70	7747x2921x1778	M	35659	16175
6SR32720.D450..0	5000	3730	779	1000				37920	17200
6SR32720.D460..0	6000	4476	935	1000				40869	18538
6SR32720.C465..0	6500	4849	1013	1250				40869	18538
6SR32720.C470..0	7000	5222	1091	1250				41830	18974
6SR32720.C475..0	7500	5595	1168	1250				42755	19393
6SR32720.C480..0	8000	5968	1246	1250				43649	19799
6SR32720.E485..0	8500	6341	1324	1375				43742	19841

6SR327 4.16 kV Motor Voltage, 9 Cell Configuration

Drive Series	Shaft Output ¹⁾		Motor Current ¹⁾	Cell Rating	Dimensions ^{2,3)} WxHxD		Weight		
	Hp	kW	A	A	in	mm	lb	kg	
6SR32720.D440..0	4000	2984	494	1000	305x115x70	7747x2921x1778	M	35266	15996
6SR32720.D450..0	5000	3730	634	1000				37419	16973
6SR32720.D460..0	6000	4476	742	1000				39370	17858
6SR32720.D465..0	6500	4849	803	1000				39370	17858
6SR32720.D470..0	7000	5222	865	1000				40285	18273
6SR32720.D475..0	7500	5595	926	1000				42067	19081
6SR32720.D480..0	8000	5968	989	1000				42242	19161
6SR32720.C485..0	8500	6341	1050	1250				43742	19841
6SR32720.C490..0	9000	6714	1112	1250				44541	20203
6SR32720.C495..0	9500	7087	1174	1250				44541	20203
6SR32720.C520..0	10000	7460	1235	1250				45317	20555
6SR32720.E522..0	11000	8206	1359	1375				46808	21232

- 1) The typical motor current and the power data are approximate values only; these have been calculated for operation with induction motors and for typical power factor $\cos \phi$ of 88% and motor efficiency of 95.2%
- 2) Outline Drawing number
- 3) Certain options will change drive dimensions, for more details see outline page

6SR327 4.8 kV Motor Voltage, 12 Cell Configuration

Drive Series	Shaft Output ¹⁾		Motor Current ¹⁾	Cell Rating	Dimensions ^{2,3)} WxHxD		Weight		
	Hp	kW	A	A	in	mm	lb	kg	
6SR32721.D440..0	4000	2984	428	1000	331x115x70	8395x2921x1778	M	38647	17530
6SR32721.D450..0	5000	3730	536	1000				40823	18517
6SR32721.D460..0	6000	4476	643	1000				42793	19411
6SR32721.D465..0	6500	4849	696	1000				42793	19411
6SR32721.D470..0	7000	5222	750	1000				43718	19830
6SR32721.D475..0	7500	5595	803	1000				44608	20234
6SR32721.D480..0	8000	5968	857	1000				45468	20624
6SR32721.D485..0	8500	6341	910	1000				47500	21546
6SR32721.D487..0	9000	6714	964	1000				48307	21912
6SR32721.C488..0	9500	7087	1017	1250				48307	21912
6SR32721.C520..0	10000	7460	1071	1250				49091	22267
6SR32721.C522..0	11000	8206	1178	1250				50598	22951
6SR32721.E524..0	12000	8952	1285	1375				52032	23601

6SR327 6.6/6.9 kV Motor Voltage, 15 Cell Configuration

Drive Series	Shaft Output ¹⁾		Motor Current ¹⁾	Cell Rating	Dimensions ^{2,3)} WxHxD		Weight		
	Hp	kW	A	A	in	mm	lb	kg	
6SR32722.D460..0	6000	4474	468	1000	356x115x70	9043x2921x1778	M	46214	20962
6SR32722.D470..0	7000	5219	545	1000				47148	21386
6SR32722.D480..0	8000	5968	623	1000				48916	22188
6SR32722.D485..0	8500	6341	662	1000				49756	22569
6SR32722.D487..0	9000	6714	701	1000				50571	22939
6SR32722.D488..0	9500	7087	740	1000				50571	22939
6SR32722.D520..0	10000	7460	779	1000				51363	23298
6SR32722.D522..0	11000	8206	857	1000				52884	23988
6SR32722.D524..0	12000	8952	935	1000				55833	25325
6SR32722.C526..0	13000	9698	1013	1250				57219	25954
6SR32722.C528..0	14000	10444	1091	1250				57890	26258
6SR32722.C530..0	15000	11190	1169	1250				59195	26850
6SR32722.C532..0	16000	11936	1246	1250				60453	27421
6SR32722.E534..0	17000	12682	1324	1375				61669	27973
6SR32722.E536..0	18000	13428	1341	1375				62885	28524

- 1) The typical motor current and the power data in hp and KW are approximate values only; these have been calculated for operation with induction motors and for typical power factor $\cos \phi$ of 88% and motor efficiency of 95.2%
- 2) Outline Drawing number
- 3) Certain options will change drive dimensions, for more details see outline page

6SR327 7.2/8.0 kV Motor Voltage, 18 Cell Configuration

Drive Series	Shaft Output ¹⁾		Motor Current ¹⁾ A	Cell Rating A	Dimensions ^{2,3)} WxHxD		Weight		
	Hp	kW			in	mm	lb	kg	
6SR32723.D480..0	8000	5968	571	1000	382x115x70	9690x2921x1778	M	52361	23751
6SR32723.D485..0	8500	6341	607	1000				53209	24135
6SR32723.D487..0	9000	6714	643	1000				54032	24508
6SR32723.D488..0	9500	7087	678	1000				54032	24508
6SR32723.D520..0	10000	7460	714	1000				54832	24871
6SR32723.D522..0	11000	8206	786	1000				56731	25733
6SR32723.D524..0	12000	8952	857	1000				57831	26232
6SR32723.D526..0	13000	9698	928	1000				61030	27683
6SR32723.D528..0	14000	10444	1000	1000	386x125x76	9563x3175x1930	M	61708	27990
6SR32723.C530..0	15000	11190	1071	1250	394x140x84	9995x3556x2134	M	63026	28588
6SR32723.C532..0	16000	11936	1143	1250				64296	29164
6SR32723.C534..0	17000	12682	1214	1250				65524	29721
6SR32723.E536..0	18000	13428	1285	1375				66713	30260
6SR32723.E538..0	19000	14174	1357	1375				67295	30524
6SR32723.E540..0	20000	14920	1285	1375				67876	30788

6SR327 10 /11 kV Motor Voltage, 24 Cell Configuration

Drive Series	Shaft Output ¹⁾		Motor Current ¹⁾ A	Cell Rating A	Dimensions ^{2,3)} WxHxD		Weight		
	Hp	kW			in	mm	lb	kg	
6SR32725.D520..0	10000	7460	514	1000	437x125x76	11100x3175x1931	N	61763	28015
6SR32725.D522..0	11000	8206	566	1000				63328	28725
6SR32725.D524..0	12000	8952	617	1000				64819	29401
6SR32725.D526..0	13000	9698	668	1000				66244	30048
6SR32725.D528..0	14000	10444	720	1000				66936	30362
6SR32725.D530..0	15000	11190	771	1000	445x140x84	11303x3556x2134	N	68278	30970
6SR32725.D532..0	16000	11936	823	1000				69573	31558
6SR32725.D534..0	17000	12682	874	1000				70824	32125
6SR32725.D536..0	18000	13428	925	1000				74437	33764
6SR32725.D538..0	19000	14174	977	1000				75030	34033
6SR32725.C540..0	20000	14920	1028	1250	450x154x90	11430x3912x2286	N	76190	34559
6SR32725.C542..0	21000	15666	1080	1250				77319	35071
6SR32725.C544..0	22000	16412	1131	1250				78420	35571
6SR32725.C546..0	23000	17158	1183	1250				79493	36057
6SR32725.C548..0	24000	17904	1234	1250				80542	36533
6SR32725.E550..0	25000	18650	1285	1375				81658	37899
6SR32725.C552..0	26000	19396	1155	1250				82573	38355
6SR32725.C554..0	27000	20331	1250	1250				83557	38801
6SR32725.C556..0	28000	20888	1243	1250				83557	38801
6SR32725.E558..0	29000	21625	1288	1375				84522	39239
6SR32725.E560..0	31000	23117	1332	1375				Consul	Factory
6SR32725.E562..0	33000	24608	1375	1375				Consul	Factory

1) The specifications for the typical motor current and the power data are approximate values only; these have been calculated for operation with induction motors and for typical power factor $\cos \phi$ of 88% and motor efficiency of 95.2% , power above 29,000HP is calculated for synchronous motor with typical power factor $\cos \phi$ of 100% and motor efficiency of 97%

2) Outline Drawing number

3) Certain options will change drive dimensions, for more details see outline page

Water-cooled Drive Dimension Drawings

Drawing M represents a standard SINAMICS Perfect Harmony GH180 water-cooled drive layout: transformer cabinet, followed by cell cabinet, control section, output section and 48" standard cooling cabinet. The only difference will be number of cells: the drawing below shows 15 cell drive with 5 sections; 9 cell drive will only have 3 sections while 24 cell configuration will have 8 sections in the cell cabinet.

There are options that will impact the dimensions of the GH180 water-cooled. The list of options includes:

- A30 touchscreen with standard cable (HMI)
- A80 12 channel RTD
- E01 Exciter furnished by Siemens
- K20 signal lamp in the cabinet door
- K21 display instruments for voltage, current and speed
- G89 controlled outgoing feeder for auxiliaries (3 phase)
- A83 Multilin 869 motor protection relay standalone option
- A82 SEL 710 motor protection relay standalone option
- E04 additional customer analog, digital inputs and outputs (I/O) modules
- L09 Output Reactor where needed
- L53 UPS
- L85 redundant control power
- W04 advanced cooling cabinet

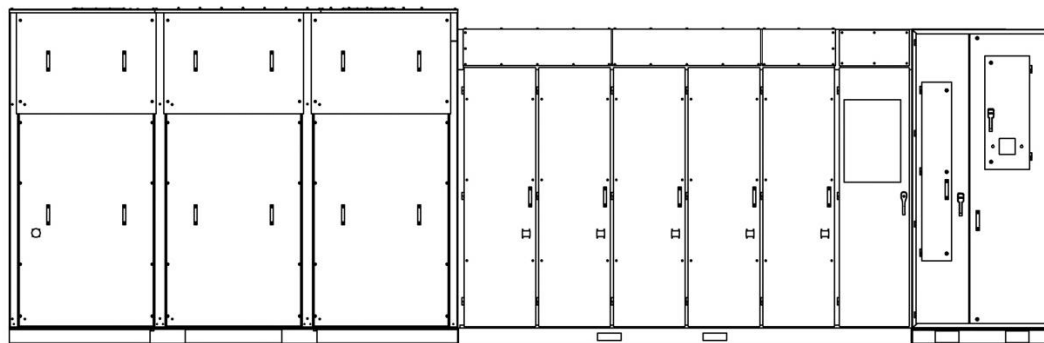

GH180 9-24 cell 880-1375A

Drawing M

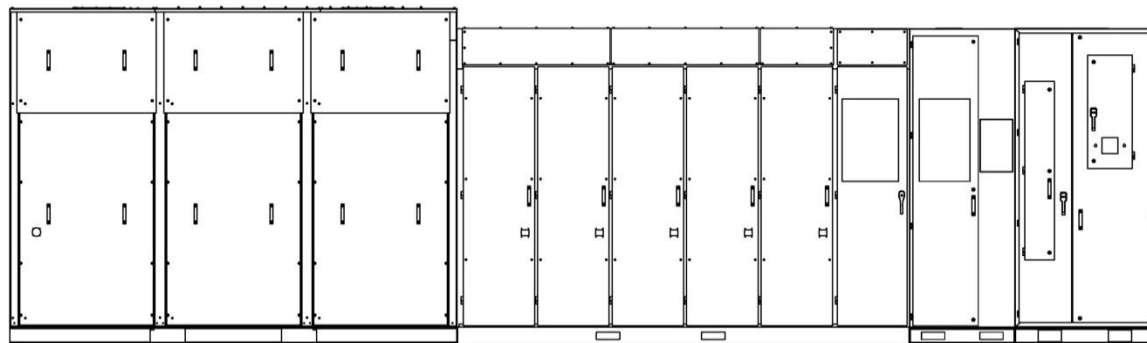

GH180 9-24 cell 880-1375A

with option cabinet (width 36") Drawing

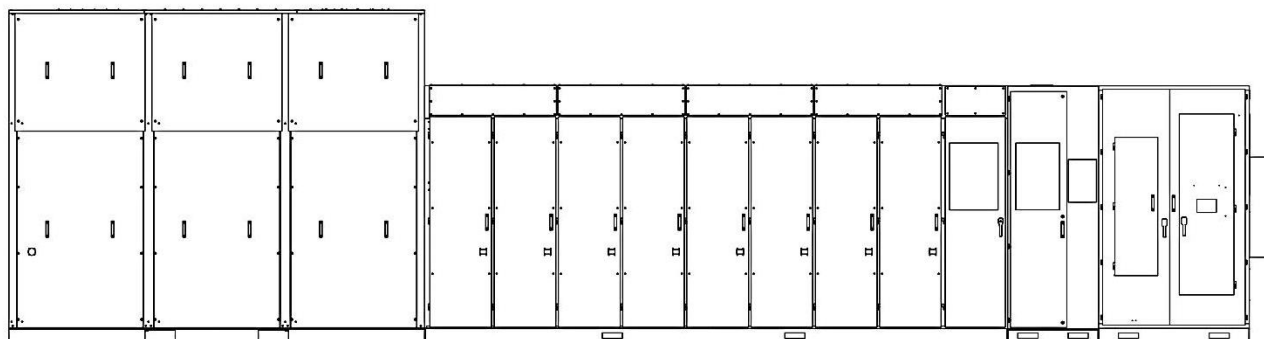

GH180 24 cell 880-1375A

with option cabinet, 60" cooling cabinet and control box of the external Liquid-to-Air Heat Exchanger

Drawing N

Air-cooled Drive Cooling Requirements

Power Losses of Drive System

Traditional way to publish heat losses for a VFD is based on the drive's efficiency - heat rejection of the drive itself or

$$\text{kW.loss} = (100\% - \text{Drive Efficiency}) \times \text{Drive.Power.kW}$$

The limitation of this approach is incorrect sizing of the VFD at full load resulting in less current required by the motor – potentially starving the motor at full load. That is why Siemens uses system approach and includes not only VFD efficiency but also motor efficiency when calculating losses for the drive:

$$\text{kW.loss} = \text{kWInput} - \text{kWOutput}$$

This ensures that a customer can not only get properly size HVAC but also properly sized drive. Typical motor efficiency used to calculate heat losses in the tables below is 95.2%.

Air cooled drives rely on circulating air to cool the components within the drive. The amount of heat generated is equivalent to the drive losses. As the drives take in as much air as is output, no building make-up air is required unless the drive has the option "Converter Prepared for duct Flange Connection" (M64 or M68), in this instance depending on your site and building configuration, Siemens will provide the required airflow and pressure drop to ensure proper drive function.

Drive Series	Shaft Output ¹⁾		With Copper Transformer	
	Hp	kW	kW	BTU/hr
6SR5	150	112	4.2	14,417
6SR5	200	149	5.6	19,223
6SR5	300	224	8.4	28,835
6SR5	400	298	11.3	38,446
6SR5	500	373	14.1	48,058
6SR5	600	448	16.9	57,670
6SR5	700	522	19.7	67,281
6SR5	800	597	22.5	76,893
6SR5	900	671	25.4	86,504
6SR5	1000	746	28.2	96,116
6SR5	1100	821	30.9	105,728
6SR5	1250	933	35.2	120,145
6SR5	1500	1119	42.3	144,174
6SR5	1750	1306	49.3	168,203
6SR5	2000	1492	56.3	192,232
6SR5	2250	1697	63.4	216,261
6SR5	2500	1865	70.4	240,290
6SR5	3000	2238	84.5	288,348
6SR5	3500	2611	98.6	336,406
6SR4	4000	2984	96.1	328,222
6SR4	5000	3730	120.2	410,278
6SR4	6000	4476	144.3	492,334
6SR4	7000	5222	168.3	574,389
6SR4	8000	5968	192.4	656,445
6SR4	9000	6714	216.4	738,501

Drive Series	Shaft Output ¹⁾		With Aluminum Transformer ¹⁾	
	Hp	kW	kW	BTU/hr
6SR5	150	112	4.8	16,548
6SR5	200	149	6.5	22,064
6SR5	300	224	9.7	33,096
6SR5	400	298	12.9	44,128
6SR5	500	373	16.2	55,160
6SR5	600	448	19.4	66,192
6SR5	700	522	22.6	77,225
6SR5	800	597	25.6	88,257
6SR5	900	671	29.1	99,289
6SR5	1000	746	32.3	110,321
6SR5	1100	821	35.6	121,353
6SR5	1250	933	40.4	137,901
6SR5	1500	1119	48.5	165,481
6SR5	1750	1306	56.6	193,061
6SR5	2000	1492	64.7	220,642
6SR5	2250	1697	72.8	248,222
6SR5	2500	1865	80.8	275,802
6SR5	3000	2238	96.9	330,962
6SR5	3500	2611	113.2	386,123
6SR4	4000	2984	112.7	384,464
6SR4	5000	3730	120.2	410,278
6SR4	6000	4476	144.3	492,334
6SR4	7000	5222	168.3	574,389
6SR4	8000	5968	192.4	656,445
6SR4	9000	6714	216.4	738,501

1) Transformer efficiency at 4500hp and above is the same for both copper and aluminum transformers

Water-cooled Cooling System Requirement

Drive with Integral Water-to-Water Heat Exchanger

SINAMICS Perfect Harmony GH180 6SR327 as a default is offered with an integral plate and frame heat exchanger. This heat exchanger consists of a series of thin, corrugated plates, spaced with rubber gaskets, to transfer heat between two fluids. This type of heat exchanger is very efficient because the fluids are exposed to the entire surface area of the plates. This is the best option if customer has water available on site.

Water-to-Water Heat Exchanger Data:

- SINAMICS Perfect Harmony GH180 heat exchanger is made of stainless steel alloy 304 or 316.
- Customer inlet water temperature: 32 - 104F (0-40C)
- Heat exchanger design pressure – 150 psi (1034.2 kPa)

The raw water must be chemically neutral, clean and free of solids. Additional specifications relating to the quality of the raw water are listed in the following table.

Variable	Specified value
Grain size of any entrained parts	< 0.5 mm
pH value	6.5 to 8.0
Carbonate hardness	< 0.9 mMol/l (5 °dH)
Total hardness	< 1.7 mMol/l (9.5 °dH)
Chlorides	< 60 mg/l
Sulfates	< 80 mg/l
Nitrates	< 10 mg/l
Iron (Fe)	< 0.2 mg/l
Ammonia	< 10 mg/l
Dissolved substances	< 3.4 mMol/l (340 ppm)

In case of deviations it is recommended to carry out an analysis of the water in order to ensure the heat exchanger's endurance strength. If the water is supplied from a lake or river, W55 option is recommended for 6SR327 – prepare for inlet water filter or specify a shell and tube heat exchanger. This is a drop ship option.

Customer Water Connections Interface: customer is responsible for water connection to the drive:

- SINAMICS Perfect Harmony GH180 6SR327 - 2" ANSI flange (DIN 50 flange)

Cold Side Flow Requirements for GH180 6SR327 with integral Water-to-Water heat exchanger:

- 9 cell – 100 GPM (378.5 LPM)
- 12 cell – 150 GPM (567.8 LPM)
- 15 cell – 200 GPM (757.1 LPM)
- 18 cell – 225 GPM (851.7 LPM)
- 24 cell – 275 GPM (1,041 LPM)

Example of integral liquid-liquid heat exchanger



Below is an example of the flow diagram:

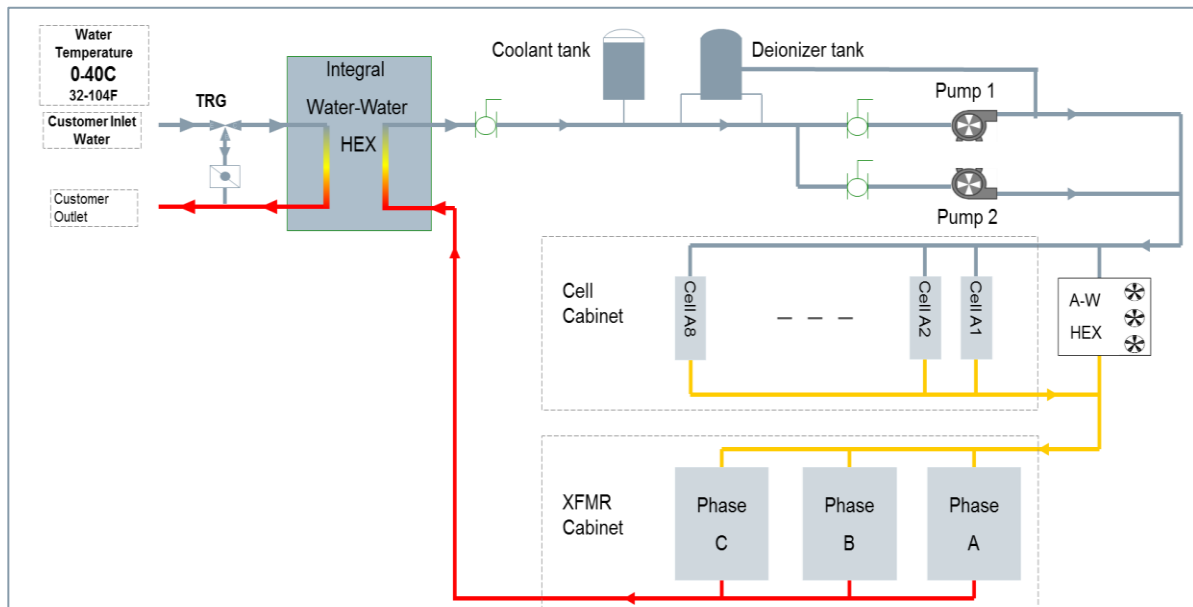

Drive Prepared for Water-to-Air Heat Exchanger

When water is not available on site SINAMICS Perfect Harmony GH180 6SR327 has an option to be installed with external water-to-air heat exchanger (W32). In this case, integral heat exchanger is removed from the circuit and replaced with set up to directly connect to external heat exchanger.

In this set up the coolant flows through the system, collecting the heat that has dissipated from the power cells and transformer, and then exits the drive, passing through the heat exchanger. As the coolant passes through the external tubing (coil) of the heat exchanger, it is cooled by a network of blowers, blowing cooler air onto the coils and reducing its temperature by means of forced convection.

Each heat exchanger fan motor has a non-fused disconnect mounted on the heat exchanger unit. The contactors for each of the fans are located inside the converter heat exchanger control panel. A separate auxiliary feed is required to the converter that powers all of the contactors.

The heat exchanger is designed to operate with standard capacity fans. There are several options available for heat exchanger: additional capacity (N+1) as an option and the heat exchanger copper coil can be coated with Heresite to protect the cooling coils from corrosion. It can be designed to be vertical or horizontal air flow. Shown below is a horizontal heat exchanger design and its installation.



Below is an example of the flow diagram:

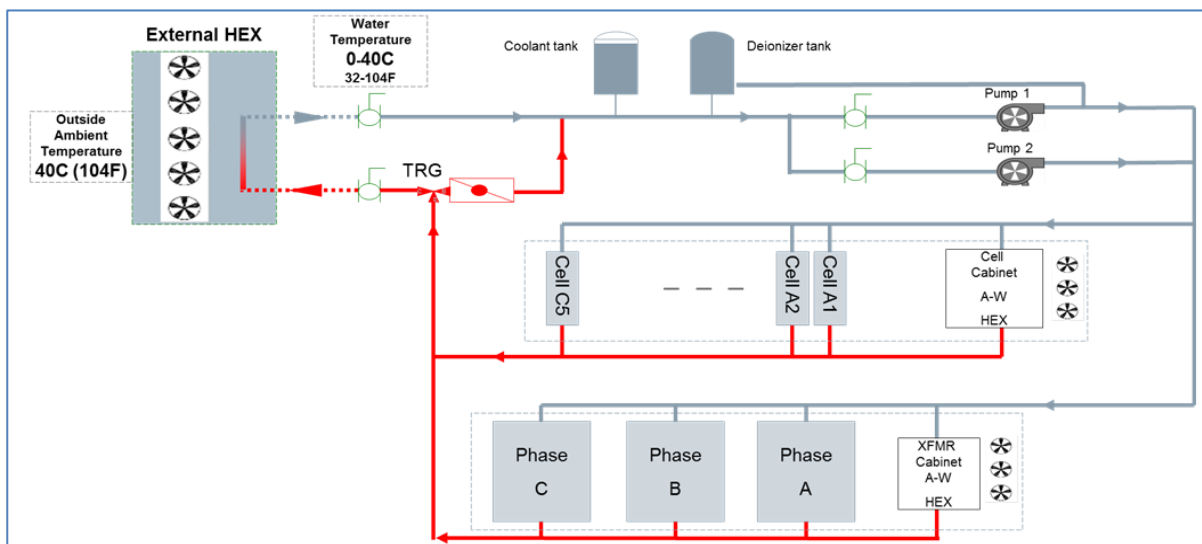

6SR327 with W32 Option flow requirement:

The flow rate depends on customer site and conditions - it is impacted by installation distance, size of the pipe and other conditions. As long as the pressure drop external to the VFD coolant cabinet is less than 15psi (103.4kPA) and the HEX is at or below the VFD elevation, the coolant system should operate as designed.

Customer Water Connections Interface: customer is responsible for water connection to the drive

- GH180 6SR327 W32 - 3" ANSI flange (DIN 80 flange)

When installing external heat exchanger, it is recommended to evaluate if you need freeze protection. When freeze protection is not required 100% deionized water is recommended. If freeze protection is required glycol should be limited to the range of 25 to 60% by volume.

Freezing Point of Coolant	% Propylene Glycol by Volume (by mass)
+10 °F / -12.2 °C	25 (25)
0 °F / -17.8 °C	32 (33)
-10 °F / -23.3 °C	39 (40)
-20 °F / -28.9 °C	44 (45)
-30 °F / -34.4 °C	48 (49)
-40 °F / -40 °C	52 (53)
-50 °F / -45.6 °C	55 (56)
-55 °F / -48 °C	60 (62)

The volume of coolant required for the drive is approximately 100 U.S gallons. To determine the total system volume, the volume in the piping to and from the Main Heat Exchanger and the volume of the Main Heat Exchanger must be determined by the customer. A Drive in the System with total volume < 250 U.S. gallons can operate with one Coolant Expansion Tank. A drive in a system with total volume between 250 - 500 U.S. gallons requires one High Capacity Coolant Expansion Tank.

Siemens Industry Services

Overview

Siemens supports end users and OEMs in improving their competitive edge. With a worldwide network of experts and technology-based services, we partner with you throughout the entire lifecycle of your machines and plants from planning and development, to operation, and even modernization – helping your plant do more.

Here's something that you might not know. Siemens drive technology includes comprehensive, basic support at no charge. That's a peace of mind few companies are willing to offer.

Just as important, we have the additional services to provide even more protection for your investment and achieve the best long-term returns. If you want to talk with an engineer on a priority basis, access technical support 24/7, or purchase OEM authorized spare parts, we give you options to buy these services as individual modules, or as a bundled package in a SIEPRO® technical service agreement.

www.siemens.com/global/en/home/products/services/industry.html

Support and Consulting Services

From the self-service advantages of a comprehensive online support website with FAQs and application examples, to technical specialists who work alongside your project managers and engineering staff, Siemens provides exactly the right amount of support and expertise – when you need it, how you need it. Advice and support that ensures your projects run smoothly and deliver the desired outcomes, on time and on budget.

- Support options include:
 - Industry online support site
 - <https://support.industry.siemens.com/cs/ww/en/sc/2235>
- Technical support services initiate via support request or 1-800-333-7421
 - Complimentary basic support
 - Priority support – 8 x 5, M-F, excluding holidays
 - Priority support – 7 x 24 x 365
 - Mature product support
 - Extended support
- Your benefits:
 - Direct access to technical experts via multiple communication channels
 - Expert analysis of system and error messages to maintain highest availability
 - Fast commissioning and reduced engineering costs
 - Achieve a high degree in planning and budgeting reliability

Digital Services

Siemens leading role in industrial data technology and its comprehensive industry knowledge, make it the ideal partner when it comes to using your equipment data to achieve improved availability, efficiency, and performance. Digital Services gives you transparency in your industrial processes and turns gained intelligence into smart decision-making.

The open cloud platform from Siemens, MindSphere, is a centerpiece of a powerful IoT - operating system with data analytics and connectivity capabilities, tools for developers, applications and services. It helps to evaluate and utilize your data and to gain breakthrough insights to drive the performance and optimization of your assets.

www.siemens.com/global/en/home/products/services/industry/digital-services.html

- Digital Services options include:
 - Energy analytics
 - Drive train and machine tool analytics
 - Industrial network analytics
 - MindSphere
 - Process data analytics
 - Plant security services
- Your benefits:
 - Data-driven intelligence to enhance investment decisions
 - Earlier detection to prevent progressive asset damage
 - Reduction of the overall cost of operation through energy efficiency
 - Avoid the risk of security incidents
 - Comprehensive and cost-effective data hosting platform and virtualized data management



Training Services

In today's competitive market, a highly skilled workforce is vital for success. However, understanding how to deploy an effective learning strategy is a challenge. Siemens can help. Rather than offering a "one-size-fits-all" solution, our technical learning services offer both standard and customized solutions to your learning needs. These solutions are available in a variety of delivery methods designed to meet the needs of your organization.

- Training options include:
 - Instructor-led Learning
 - Self-paced learning
 - Virtual instructor-led learning
 - How-to video library
 - Virtual mentoring
 - On-the-Job learning
- Your benefits:
 - Build staff skills and expertise for enhanced performance
 - Ensure knowledge continuity
 - Reduce downtime and maintenance costs
 - Optimize processes and improve safety

<https://support.industry.siemens.com/cs/ww/en/sc/2226>

Spare Parts Services

Leveraging our network of regional warehouses and state-of-the-art logistics ensures fast access to the spare parts you need. You can't afford downtime – this service ensures a rapid response and reliable supply of spare parts, saving you time and money, and enabling you to reduce your own spare parts warehousing requirements.

- Parts Service options include:
 - Lifecycle assessments – identify and mitigate lifecycle risks on plant floor
 - Asset optimization services – customized solution for addressing spare parts needs
 - Guaranteed availability
 - Extended warranty
- Your benefits:
 - Guaranteed OEM quality
 - Fast handling and professional logistics – same-day order processing as standard
 - Three options offered on most inquiries: outright purchase, exchange, repair
 - Optimal stocking strategies to reduce on-site inventory and costs
 - Regional stocking facilities reduce unplanned downtime

<https://support.industry.siemens.com/cs/ww/en/sc/2110>

Repair Services

Reliable electrical and electronic equipment is vital for operating continuous processes. To keep critical equipment such as motors, drives, and CNCs up and running requires highly specialized, factory-certified maintenance and repair. Siemens provides the full range of repair services you need via our certified U.S. repair centers. The repair services include all measures necessary to quickly restore the functionality of inoperable units.

- Drive Repair Services include:
 - Low and medium voltage drive systems (AC & DC)
 - Servo and spindle motors, motorized spindles
 - Industrial motors (AC & DC) and generators
 - Industrial PC, PLC, and HMI repair
- Your benefits:
 - Global service center network
 - OEM quality - only factory-authorized repair centers in the U.S.
 - Restoration to original factory specifications
 - Proper care of assets to increase uptime and reduce total cost of operations
 - Guaranteed OEM spare parts and testing procedures

<https://support.industry.siemens.com/cs/sc/2154>

Field and Maintenance Services

Our factory-certified field service specialists have the knowledge to get your equipment up and running in the shortest time. You can rely on our dedicated team of engineers and technicians to deliver the services you need safely, professionally, and in compliance with all local and governmental regulations. We are on-call 24/7, throughout the year, to support you with installation, commissioning, maintenance, troubleshooting, and emergency services.

<https://support.industry.siemens.com/cs/ww/en/sc/2265>

- Your benefits:
 - World-wide service infrastructure
 - Comprehensive training and technical expertise to complement your resources
 - Maximum availability through preventive maintenance
 - Plant efficiency to reach strategic business objectives



Retrofit and Modernization Services

Keeping pace with the constant demand to improve productivity, reduce costs, and increase quality is a challenge our customers deal with every day. In the case of stretched capital budgets, retrofitting or modernizing an existing product or system gives you access to new technologies and provides an attractive alternative that will deliver maximum value for your investment.

- Modernization Services include:
 - Drive upgrades
 - Complete motor and drive retrofits (Siemens products and other 3rd parties)
 - DC to AC motors
- Your benefits:
 - Upgrade to the latest technology with easy adjustment to the existing equipment
 - Targeted identification of savings potentials, including energy
 - Higher productivity and lower maintenance costs
 - Long-term security of investments

<https://support.industry.siemens.com/cs/ww/de/sc/2286>

Service Programs and Agreements

Designed for flexibility, a SIEPRO® Technical Service Agreements lets you bundle the exact services you need in a preventive program that reduces unplanned downtime and operational costs. You select the level of service that best complements your equipment, processes, and existing capabilities, then tailor your program with optional services to meet specific demands.

- Service programs and agreement options include:
 - Standard packages ranging from parts-only to onsite service with priority technical support
 - Custom services:
 - Asset optimization
 - Block of hours
 - Data analytics
 - Embedded engineer
 - Guaranteed parts availability
 - Lifecycle assessments
 - Maintenance workshops
 - Mature product support
 - Preventive maintenance
 - Spare parts packages
 - Training services
- Your benefits:
 - Price stability through predictable costs and optimized maintenance expense
 - Forward-thinking maintenance that improves availability and reduces risk of failure
 - Budget transparency and payment options to suit your operations
 - Avoiding unplanned downtime and costly emergency repairs
 - Ensure quality and delivery of genuine Siemens spare parts

<https://support.industry.siemens.com/cs/ww/de/sc/2275>



Scope of Supply

The standard scope of delivery of the SINAMICS PERFECT HARMONY GH180 includes:

- Input section
- Transformer section
- Cell section
- Control section
- Output section

The basic unit of each SINAMICS PERFECT HARMONY GH180 Water-cooled product line consists of the following:

- Input section
- Transformer cabinet section
- Cell cabinet section
- Control section
- Output section
- If Water-to-Water Heat Exchanger is selected: coolant cabinet section comes with integral water-to-water heat exchanger

SINAMICS Perfect Harmony GH180 6SR327 Water-to-Air heat exchanger is delivered and located separately.

The water-cooled drive coolant cabinet is delivered without de-ionized water.

The necessary pipes and connection pieces from converter coolant system to raw-water supply on the plant side are not included in the scope of supply.

Input and output cables are not included in the scope of supply.

Accessories

Cell lifter

The power cells of SINAMICS Perfect Harmony GH180 drives can be replaced as a unit. To replace, the entire power cell must be removed from the drive and transported on a cell lifter. Appropriate cell lifters are available for SINAMICS Perfect Harmony GH180 drives.

Some cell lifters can be used to replace blowers as well. Please, contact your local factory for more details.

Recommended List of Spare Parts

Spare Part Packages ensure that a customer has necessary components to deal with emergencies. These packages are recommended but not required. The components within the kits will vary depending on drive generation and cooling method.

Each manufacturing location identifies components that meet their customers base requirements. For more details about available spares contact your Siemens Service Representative.

Below is the list of spare part packages recommended for GH180:

Basic Spare Parts Package List

Description	Quantity
Power Cell	1
NXG Control Box (DCR)	1
System Interface Board	1
User I/O Board	1
Cell Fiber Optic Kit	1

Below is an example of the advanced spare parts package with some of the components included in it. This package is typically sold after the equipment is commissioned or at any time during drive operating life. For more complete list contact your Siemens Service Representative.

Air-Cooled Advanced Spare Parts Package List

Description	Quantity
Control (NXG) Power Supply	1
Keypad	1
Fuses	
Blower and Blower Accesories	1
Bypass Contactor	1
Bypass Power Supply Fuse	1
Bypass Control Board	1

Water-Cooled Advanced Package Spare Parts List

Description	Quantity
Control (NXG) Power Supply	1
Keypad	1
Fuses	
Pump and Pump Accesories	1
Bypass Contactor	1
Bypass Power Supply Fuse	1
Bypass Control Board	1

Options Availability By Manufacturing Location

X –Option is available; E – some Engineering required, AC – Air-cooled only option, WC – Water-cooled only option

Options	Location		
	China	Germany	USA
A			
A30 Touchscreen with standard cable (HMI)			x
A80 TEC System RTD monitor			x
A82 SEL 710 motor protection relay			E
A83 Multilin 869 motor protection relay			E
A84 Advanced Motor Protection and Monitoring	E		x
A85 12 channel RTD monitor	E		x
B			
B43 Production schedule: one issue		x	x
B44 Production schedule: updated at 2-week intervals		x	x
B45 Production schedule: updated once per month		x	x
D			
D00 Documentation in German		x	x
D02 Circuit diagrams, terminal diagrams and dimension drawings in DXF format	x	x	x
D15 One set of printed documentation	x	x	x
D56 Documentation in Russian	x	x	x
D76 Documentation in English	x	x	x
D79 Documentation in Portuguese (Brazil)		x	x
D84 Documentation in Chinese	x	x	x
E			
E01 Motor static exciter furnished by Siemens			WC
E04 Additional Customer Analog, Digital Inputs and Outputs (I/O) Modules		x	x
F			
F03 Visual acceptance of the drive		x	
F73 Functional acceptance of the drive with inductive load	x	x	
F77 Acceptance test of the insulation of the drive		x	
F79 Interface check with customer equipment (5 hours, on request)		x	
F97 Customer-specific acceptance		x	
F02 Class 1 Witness Test			x
F94 Class 2 Witness Test			x
F95 Class 3 Witness Test			x
G			
G19 SIDrive IQ			x
G22 Modbus RTU interface, network	x	x	x
G23 DeviceNet profile 12 interface, network 1	x	x	x
G26 Control Net interface, network 1	x	x	x
G28 Modbus Ethernet interface, network 1	x	x	x
G32 Modbus RTU interface, network 2	x	x	x
G37 EtherNet/IP interface, network 1	x	x	x
G34 Profinet	x		
G38 Modbus Ethernet interface, network 2	x	x	x
G39 EtherNet/IP interface, network 2	x	x	x
G42 Ethernet network switch with fiber optic port		x	x

Options	Location		
	China	Germany	USA
G43 DeviceNet profile 12 interface, network 2	x	x	x
G46 Control Net interface, network 2	x	x	x
G47 Ethernet port connector mounted on the door	x	x	x
G50 VFD Control Via Fieldbus Network Communication			E
G89 Digital relay contactor control of external auxiliaries			WC
G91 PROFIBUS DP interface, network 1	x	x	x
G93 PROFIBUS DP interface, network 2	x	x	x
K			
K20 Signal lamp on the cabinet door	x	x	x
K21 Display instruments for voltage, current and speed	x	x	x
K29 Pushbutton / Potentiometer Kit	x	x	x
K31 Off-Local-Remote selector switch	x	x	x
K32 Off-Hand-Auto selector	x	x	x
K33 Keyed Off-Local-Remote selector	x	x	x
K34 Keyed Off-Hand-Auto selector	x	x	x
K50 Closed loop vector control with provision for speed encoder	x	x	x
K68 Control voltage 220V AC by customer.	x	x	WC
K69 Control voltage 120 V AC by Siemens	x	x	x
K73 I/O signal voltage 24 V DC	x	x	x
K79 Control voltage 120 V AC by customer	x	x	x
L			
L29 Bidirectional Synchronized Transfer	x	x	x
L53 UPS for power supply of the control	x	x	x
L03 EMC filter	x	x	x
L09 Output reactor	x	x	x
L29 Bidirectional synchronized transfer	x	x	x
L20 Bidirectional synchronized transfer of multiple motors, switchgear provided by customer			x
L33 Regenerative breaking			WC
L50 Cabinet lighting and service socket outlet	x	x	x
L55 Anti-condensation heating for cabinet	x	x	x
L81 2 x 2 thermistor protection relays		x	
L82 3 x 2 thermistor protection relays		x	
L85 Redundant Control Power			WC
L91 2 Pt100 evaluation units with 3 inputs each		x	
L93 Pt100 evaluation unit with 6 inputs and 2 analog outputs		x	
L95 Pt100 evaluation unit with 6 inputs for ex-proof motors and 6 analog outputs		x	
M			
M08 Superior - Mechanical door interlock		x	x
M09 Kirk - Mechanical door interlock		x	x
M12 Electrical door interlocks	E	x	
M29 Painted Gland plates			x
M35 Aluminum Gland plates	x	x	x
M36 Brass Gland plates	x	x	x
M37 Stainless Steel Gland plates		x	x
M38 Fortress - Mechanical door interlock	E		E
M42 IP42 degree of protection	x	x	x

Options	Location		
	China	Germany	USA
M57 Arc Resistant Design			x
M58 Outdoor Duty Drive			x
M61 Redundant blower	x	x	x
M64/M68 Drive prepared for duct flange connection in front/rear	x	x	x
M79 Copper system bus			x
M88 Premium Corrosion Protection			WC
M97 RAL 7035	x	x	
M98 ANSI 61			x
N			
N02 Interface with customer circuit breaker – DC rated dry contacts			WC
N03 Interface with customer circuit breaker – AC rated dry contacts			WC
N10 Prepared for input contactor			AC
N13 Prepared for input circuit breaker			AC
N17 Bidirectional synchronized transfer of one motor, switchgear provided by Siemens			AC
N18 Bidirectional synchronized transfer of multiple motors, switchgear provided by Siemens			AC
N26 Synchronized pre-charge and pre-magnetization of transformer			WC E AC
N35 Controlled outgoing feeder for auxiliaries max. 1.2 kW	x	x	x
N36 Controlled outgoing feeder for auxiliaries max. 2.2 kW	x	x	x
N37 Controlled outgoing feeder for auxiliaries max. 3.5 kW	x	x	x
N38 Controlled outgoing feeder for auxiliaries max. 4.5 kW	x	x	x
N40 Internal control cabling with SIS (Synthetic Insulated Switchboard) Wire			AC
N44 Make-proof grounding switch at drive input	x	x	
N45 Make-proof grounding switch at drive output	x	x	
N50 Internal cabling with halogen-free cables	E	x	
N75 Power supply for external devices 24 V		x	
N94 Grounding Studs	x	x	x
P			
P40 Transformer assembly lift points outside on cabinet roof			WC
Q			
Q80 12 months extension to a total of 24 months (2 years) from delivery	x	x	x
Q81 18 months extension to a total of 30 months (2½ years) from delivery	x	x	x
Q82 24 months extension to a total of 36 months (3 years) from delivery	x	x	x
Q83 30 months extension to a total of 42 months (3½ years) from delivery	x	x	x
Q84 36 months extension to a total of 48 months (4 years) from delivery	x	x	x
Q85 48 months extension to a total of 60 months (5 years) from delivery	x	x	x
S			
S17 Unmanned Station option			E
T			
T03 White letters with black core	x	x	x
T04 Stainless steel	x	x	x
T58 Nameplate, warning labels in English/French		x	x
T74 Nameplate, warning labels in English/German		x	x
T76 Nameplate, warning labels in English	x	x	x
T80 Nameplate, warning labels in English/Italian		x	x
T82 Nameplate, warning labels in English/Portuguese		x	x

Options	Location		
	China	Germany	USA
T85 Nameplate, warning labels in English/Russian	x	x	x
T91 Nameplate, warning labels in English/Chinese	x	x	x
U			
U01 Version with UL listing			x
U02 Version with CE conformity	x	x	x
U03 Version with CSA certification			x
U04 EAC certificate	x	x	E
U10 Process Tolerant Protection Strategy - ProToPS™	x	x	x
U11 Advanced Cell Bypass	x	x	x
U12 N+1 Cell redundancy	x	x	AC
U13 One redundant cell per phase		x	AC
U21 N+1 Cell redundancy			WC
U22 N+2 redundant cells			WC
U57 High temperature			x
U58 Elevated BIL			x
U60 High Altitude ≤ 1500m (5000ft) @ 40°C	x	x	x
U61 High Altitude ≤ 2000m (6600ft) @ 40°C	x	x	x
U62 High Altitude ≤ 2500m (8200ft) @ 40°C	x	x	x
U63 High Altitude ≤ 3000m (10000ft) @ 40°C	x	x	x
U64 High Altitude ≤ 3500m (12000ft) @ 40°C	x	x	x
U65 High Altitude ≤ 4000m (13300ft) @ 40°C	x	x	x
V			
V01 2.3 kV Motor Voltage	x		x
V02 2.4 kV Motor Voltage	x		x
V03 3.0 kV Motor Voltage	x	x	x
V04 3.3 kV Motor Voltage	x	x	x
V05 4.0 kV Motor Voltage	x		x
V06 4.16 kV Motor Voltage	x		x
V07 4.8 kV Motor Voltage	x		x
V08 5.0 kV Motor Voltage	x		x
V09 5.5 kV Motor Voltage	x		x
V10 6.0 kV Motor Voltage	x	x	x
V11 6.3 kV Motor Voltage	x	x	x
V12 6.6 kV Motor Voltage	x	x	x
V13 6.9 kV Motor Voltage			x
V14 7.2 kV Motor Voltage			x
V15 8.0 kV Motor Voltage			x
V18 10.0 kV Motor Voltage	x		x
V19 11.0 kV Motor Voltage	x		x
W			
W05 Coolant cabinet high capacity expansion tank			WC
W04 Advanced Cooling Cabinet			WC
W32 Drive prepared for liquid-air heat exchanger			WC
W35 Liquid to air heat exchanger control panel mounted on outside of the coolant cabinet			WC
W41 Drive prepared for air-to-air heat exchanger			AC E

Options	Location		
	China	Germany	USA
W51 Mechanical two way inlet water temperature regulating valve			WC
W52 Mechanical three way inlet water temperature regulating valve			WC
W55 Prepared for inlet water filter for low-quality water			WC
W71 Siemens provided deionized water			WC
W72 Siemens provided propylene glycol			WC
Y			
Y05 Customer-specific nameplate	x	x	x
Y09 Paint finish other than standard	x	x	x
Y10 Circuit diagrams with customer-specific description field.	x	x	x
Y15 Output Filter		x	x
Y36 Customer-specific cabinet labels		x	x

Get more information

Siemens Drive Technology:
www.siemens.com/drives

The drives family SINAMICS:
www.siemens.com/sinamics

North America
 Siemens Industry, Inc.
 Large Drive Applications
 100 Technology Drive
 Alpharetta, GA 30005
 USA

Subject to change without prior notice
 All rights reserved
 Order No.: LACA-00400-0918
 Subject to change without prior notice
 Only PDF
 © 2019 Siemens Industry, Inc.

Global Address
 Large Drive Applications
 Postfach 47 43
 90025 Nürnberg
 GERMANY

The technical data presented in this document is based on an actual case or on as-designed parameters, and therefore should not be relied upon for any specific application and does not constitute a performance guarantee for any projects. Actual results are dependent on variable conditions. Accordingly, Siemens does not make representations, warranties, or assurances as to the accuracy, currency or completeness of the content contained herein. If requested, we will provide specific technical data or specifications with respect to any customer's particular applications.

Our company is constantly involved in engineering and development. For that reason, we reserve the right to modify, at any time, the technology and product specifications contained herein.



Security information

Siemens provides products and solutions with industrial security functions that support the secure operation of plants, systems, machines and networks.

In order to protect plants, systems, machines and networks against cyber threats, it is necessary to implement – and continuously maintain – a holistic, state-of-the-art industrial security concept. Siemens' products and solutions only form one element of such a concept.

Customer is responsible to prevent unauthorized access to its plants, systems, machines and networks. Systems, machines and components should only be connected to the enterprise network or the internet if and to the extent necessary and with appropriate security measures (e.g. use of firewalls and network segmentation) in place.

Additionally, Siemens' guidance on appropriate security measures should be taken into account. For more information about industrial security, please visit

www.siemens.com/industrialsecurity.

Siemens' products and solutions undergo continuous development to make them more secure. Siemens strongly recommends to apply product updates as soon as available and to always use the latest product versions. Use of product versions that are no longer supported, and failure to apply latest updates may increase customer's exposure to cyber threats.

To stay informed about product updates, subscribe to the Siemens Industrial Security RSS Feed under www.siemens.com/industrialsecurity.