



BYD Microelectronics Co., Ltd.

BF96N60/ BF96N60L

600V N-Channel MOSFET

General Description

These N-Channel enhancement mode power field effect transistors are produced using DMOS technology.

This advanced technology has been especially tailored to minimize on-state resistance, provide superior switching performance, and withstand high energy pulse in the avalanche and commutation mode. These devices are well suited for high efficiency switched mode power supplies, active power factor correction, electronic lamp ballasts based on half bridge topology.

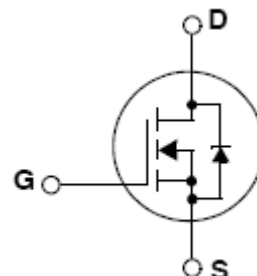

Features

- $V_{DS} = 600\text{ V}$
- $I_D = 6\text{ A}$
- $R_{DS(ON)} = 1.7\ \Omega$ TYP ($V_{GS} = 10\text{ V}, I_D = 3.0\text{ A}$)
- Low C_{RSS} (typical 7.0pF)
- Fast switching



Absolute Maximum Ratings

Symbol	Parameter	BF96N60L	BF96N60	Unit
V_{DS}	Drain-Source Voltage	600		V
I_D	Drain Current(continuous)at $T_c = 25^\circ\text{C}$	6		A
I_{DM}	Drain Current (pulsed) (Note1)	24		A
V_{GS}	Gate-Source Voltage	± 30		V
E_{AS}	SinglePulseAvalanche Energy (Note2)	190		mJ
I_{AR}	Avalanche Current (Note1)	6		A
E_{AR}	RepetitiveAvalancheEnergy (Note1)	12.5		mJ
dv/dt	PeakDiodeRecovery dv/dt (Note3)	5		V/ns
P_D	Power Dissipation ($T_c = 25^\circ\text{C}$)	125	40	W
T_{stg}	Storage Temperature Range	-55 to +150		$^\circ\text{C}$
T_L	Maximum Lead Temperature for Soldering Purpose	300		$^\circ\text{C}$



Ordering Information

Part Number	Package	Packaging
BF96N60	TO-220F	Tube
BF96N60L	TO-220	Tube

Thermal Data

Symbol	Parameter	TO-220F	TO-220	Unit
Rthj-case	Thermal Resistance Junction-case	3.1	1.0	°C /W
Rthj-amb	Thermal Resistance Junction-ambient	62.5	62.5	°C /W

Electrical Characteristics(T_c = 25°C)

Symbol	Parameter	Test Conditions	Min.	Typ.	Max.	Unit
V _{(BR)DSS}	Drain-Source Breakdown Voltage	I _D =250uA, V _{GS} =0V	600			V
I _{DSS}	Zero Gate Voltage Drain Current	V _{DS} =600V, V _{GS} =0V			1	uA
		V _{DS} =600V, V _{GS} =0, T _c =125°C			10	uA
I _{GSS}	Gate-Body Leakage Current	V _{GS} =±30V, V _{DS} =0V			±100	nA
V _{GS(th)}	Gate Threshold Voltage	V _{DS} =V _{GS} , I _D =250uA	2.0		4.0	V
R _{DS(on)}	Static Drain-Source On Resistance	V _{GS} =10V, I _D =3.0A		1.7	2.1	Ω
C _{iss}	Input Capacitance	V _{DS} =25V, f=1MHZ, V _{GS} =0V		938		pF
C _{oss}	Output Capacitance		64		pF	
C _{rss}	Reverse Transfer Capacitance		7.0		pF	
t _{d(on)}	Turn-On Delay Time	V _{DD} =300V, I _D =3A V _{GS} =10V, R _G =4.7Ω (Note4,5)		25		ns
t _r	Rise Time		15		ns	
t _{d(off)}	Turn-Off Delay Time		60		ns	
t _f	Fall Time		15		ns	
Q _g	Total Gate Charge	V _{DD} =480V, I _D =6A V _{GS} =10V (Note4,5)		23.4		nC
Q _{gs}	Gate-Source Charge		8.2		nC	
Q _{gd}	Gate-Drain Charge		6.4		nC	
V _{SD} (*)	Forward On Voltage	I _F =6A, V _{GS} =0V		0.82	1.2	V
T _{rr}	Reverse Recovery Time	V _{DD} =300V, I _F =6A, di/dt=100A/us (Note4)		400		ns

Notes:

1. Repetitive Rating : Pulse width limited by maximum junction temperature
 2. L = 10mH, I_{AS} = 6 A, V_{DD} = 50V, R_G = 25 Ω, Starting T_J = 25°C
 3. I_{SD} ≤ 6A, di/dt ≤ 200A/μs, V_{DD} ≤ BV_{DSS}, Starting T_J = 25°C
 4. Pulse Test : Pulse width ≤ 300μs, Duty cycle ≤ 2%
 5. Essentially independent of operating temperature
- (*). Pulsed: Pulse duration



Typical characteristics (25°C unless noted)

Figure 1 Output Characteristics

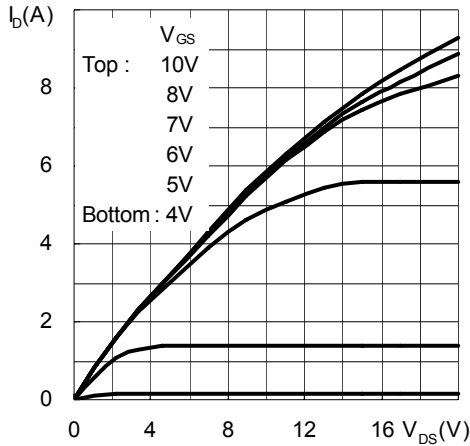

Figure 2 Transfer Characteristics

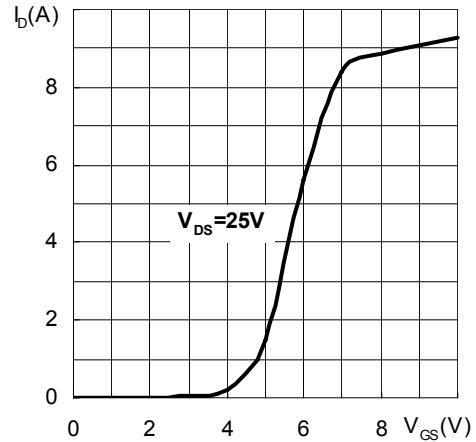

Figure 3 Normalized Threshold Voltage vs. Temperature

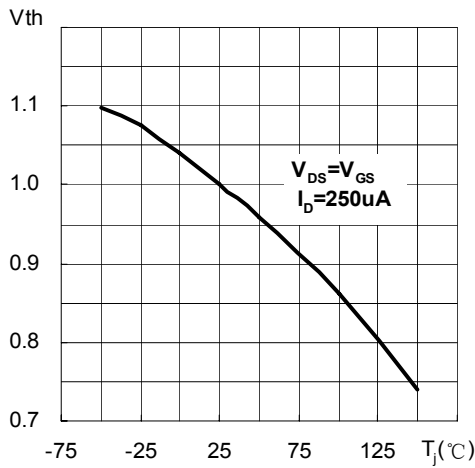

Figure 4 Normalized BV_{DSS} vs. Temperature

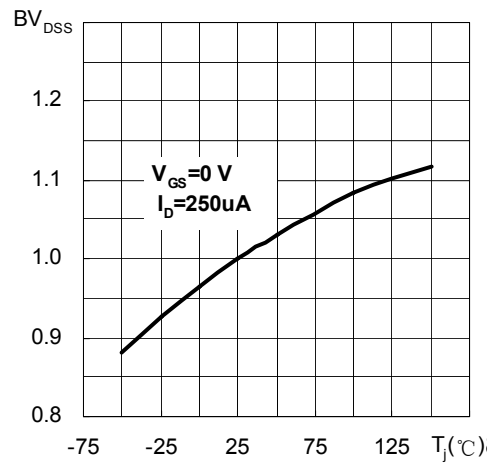

Figure 5 Normalized on Resistance vs Temperature

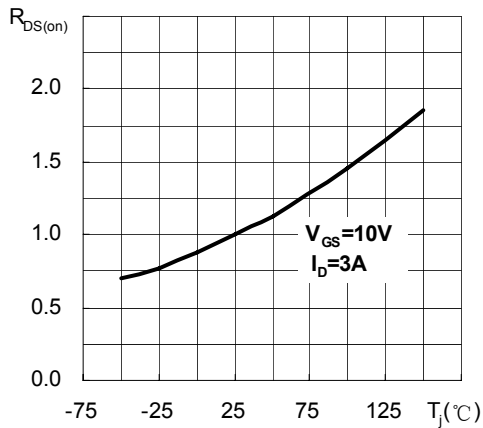

Figure 6 Source-Drain Diode Forward Characteristics

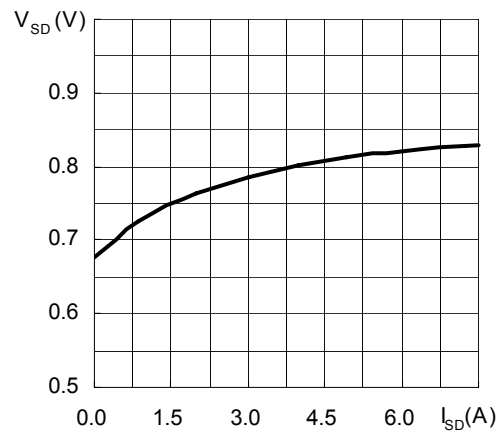



Figure 7 Capacitance

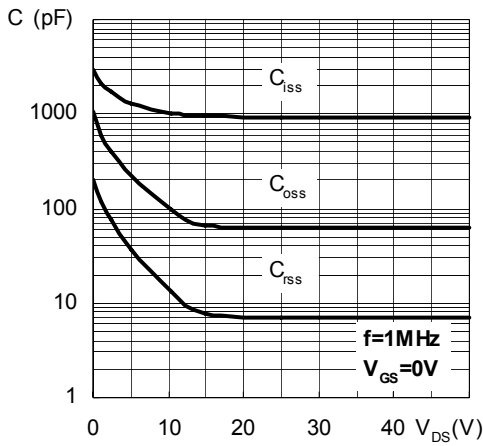

Figure 8 Gate Charge

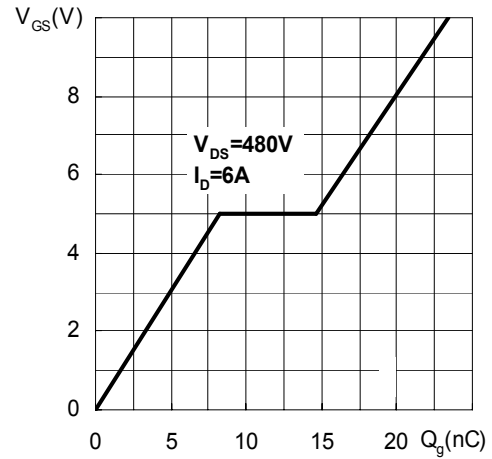

Figure 9-1 Safe Operating Area For BF96N60

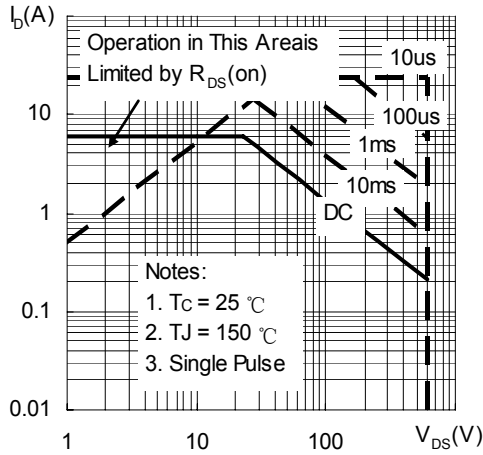

Figure 9-2 Safe Operating Area For BF96N60L

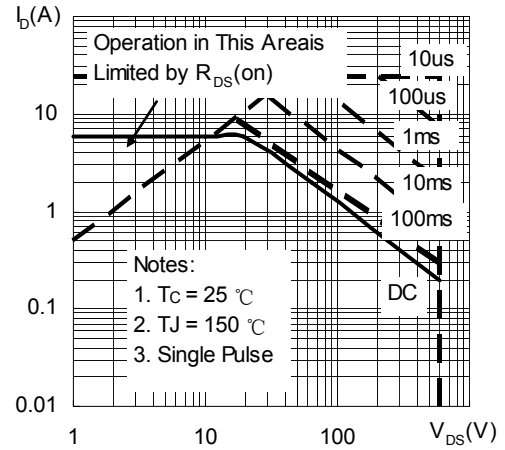

Figure 10 Maximum Drain Current vs Case Temperature

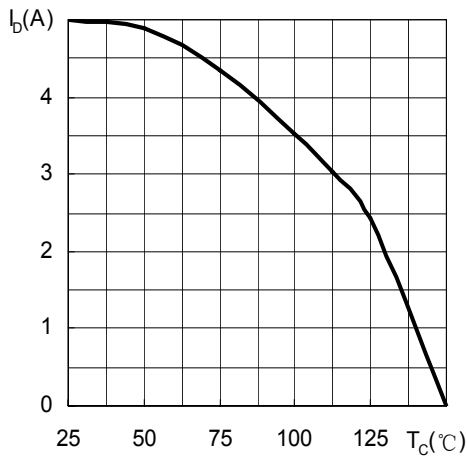

Figure 11-1 Maximum Transient Thermal Impedance For BF96N60

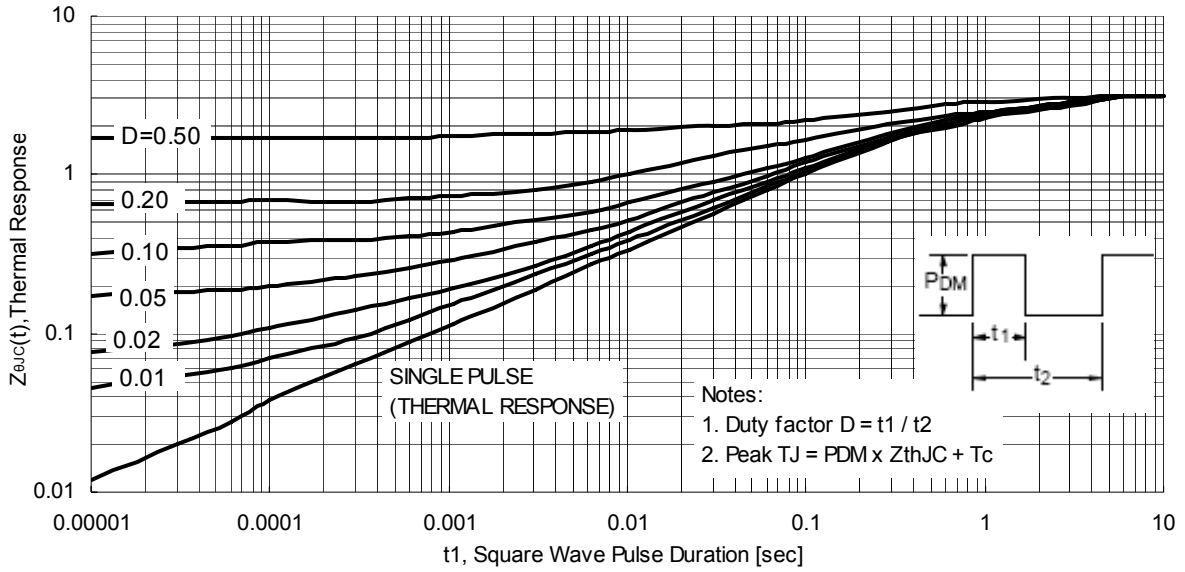
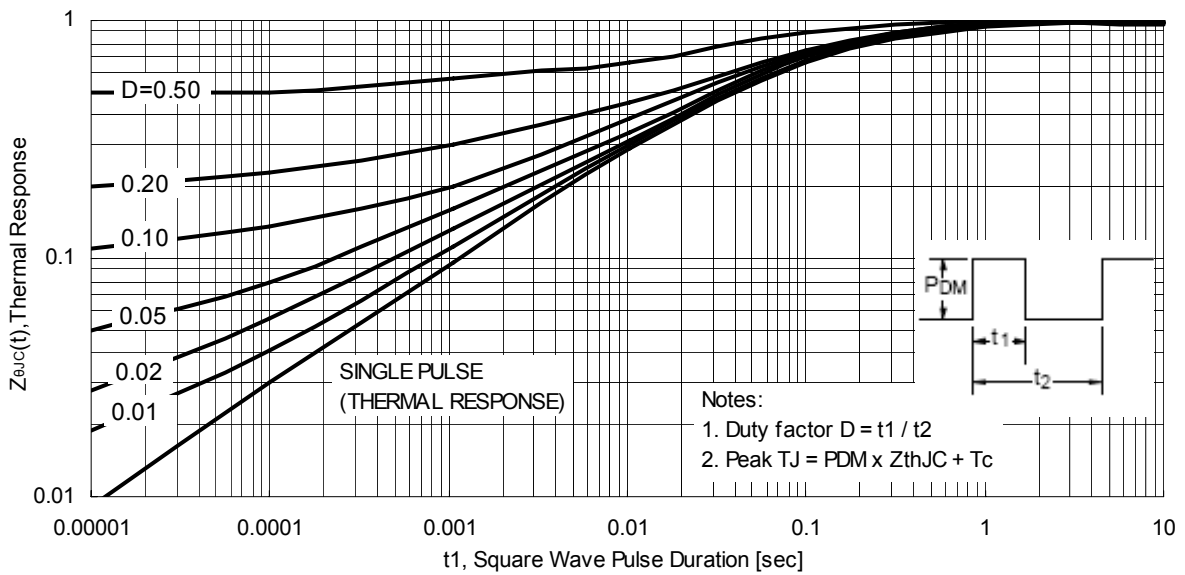
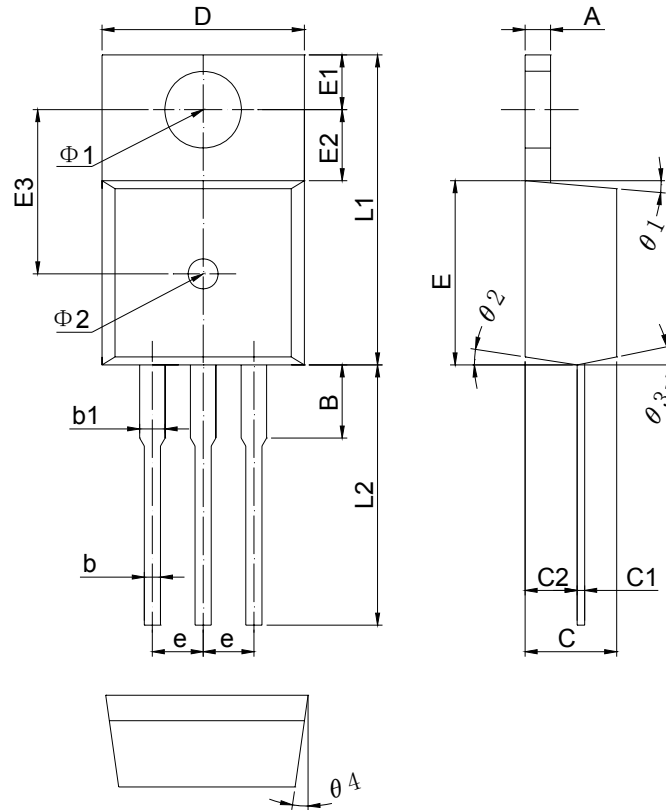

Figure 11-2 Maximum Transient Thermal Impedance For BF96N60L





Package Drawing
TO-220



Symbol	Dimensions In Millimeters			Dimensions In Inches		
	Min	Nom	Max	Min	Nom	Max
A	-	1.27	-	-	0.050	-
B	-	3.65	-	-	0.144	-
b	-	0.81	-	-	0.032	-
b1	-	1.27	-	-	0.050	-
C	-	4.58	-	-	0.180	-
C1	-	0.38	-	-	0.015	-
C2	-	2.60	-	-	0.102	-
D	10.10	10.12	10.14	0.398	0.398	0.399
E	-	9.20	-	-	0.362	-
E1	-	2.74	-	-	0.108	-
E2	-	3.55	-	-	0.140	-
E3	-	8.20	-	-	0.323	-
e	2.515	2.54	2.565	0.099	0.100	0.101
L1	15.47	15.49	15.51	0.609	0.610	0.611
L2	13.00	-	-	0.512	-	-
$\theta 1$	3°			3°		
$\theta 2$	3°			3°		
$\theta 3$	3°			3°		
$\theta 4$	3°			3°		
$\phi 1$	3.84			0.151		
$\phi 2$	1.5			0.059		

TO-220F

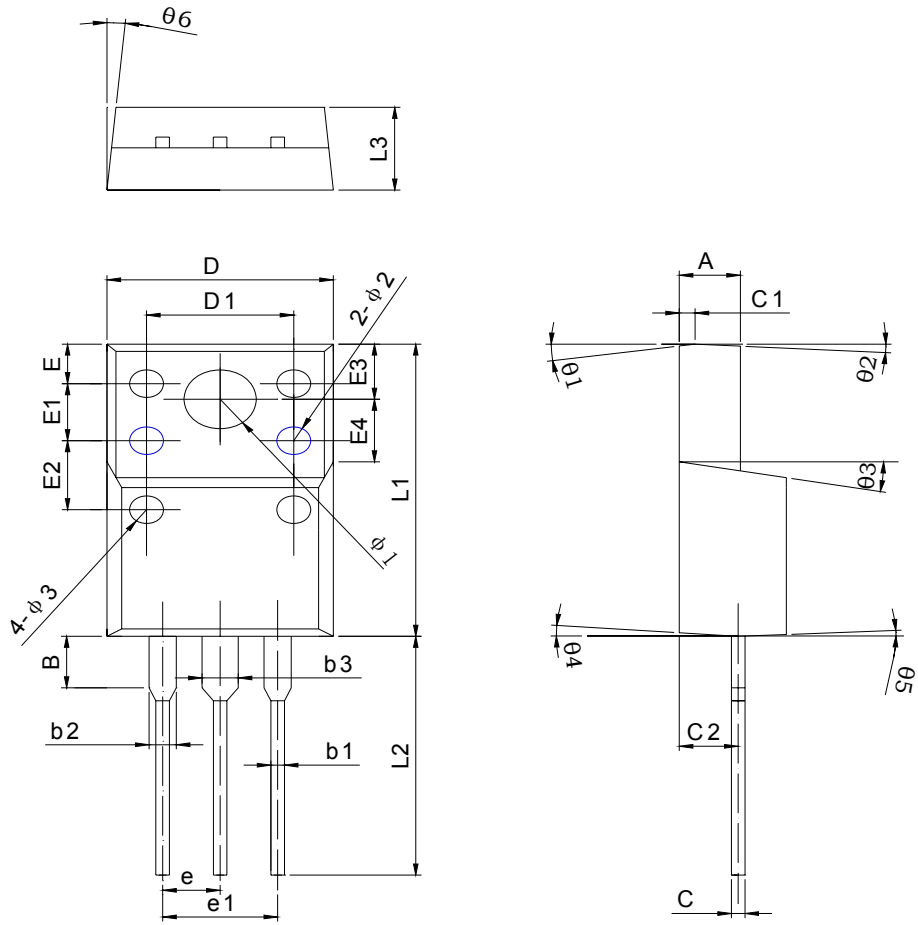



Symbol	Dimensions In Millimeters			Dimensions In Inches		
	Min	Nom	Max	Min	Nom	Max
A	2.50	2.70	2.90	0.098	0.106	0.114
B	2.60	2.80	3.00	0.102	0.110	0.118
b1	0.50	0.60	0.70	0.020	0.024	0.028
b2	1.10	1.20	1.30	0.043	0.047	0.051
b3	-	1.60	-	-	0.063	-
C	0.55	0.60	0.65	0.022	0.024	0.026
C1	-	0.60	-	-	0.024	-
C2	2.40	2.60	2.80	0.094	0.102	0.110
D	9.80	10.00	10.20	0.386	0.394	0.402
D1	-	6.50	-	-	0.256	-
E	-	2.15	-	-	0.085	-
E1	-	3.10	-	-	0.122	-
E2	-	3.75	-	-	0.148	-
E3	2.90	3.00	3.10	0.114	0.118	0.122
E4	3.30	3.40	3.50	0.130	0.134	0.138
e	-	2.54	-	-	0.100	-
e1	4.98	5.08	5.18	0.196	0.200	0.204
L1	14.80	15.00	15.20	0.583	0.591	0.598
L2	13.00	13.20	13.40	0.512	0.520	0.528
L3	4.30	4.50	4.70	0.169	0.177	0.185
θ1	5°			5°		
θ2	3°			3°		
θ3	10°			10°		
θ4	5°			5°		
θ5	3°			3°		
θ6	5°			5°		
φ1	3.00	3.20	3.40	0.118	0.126	0.134
φ2	1.50 深 1.2 头部 160°			1.50 深 1.2 头部 160°		
φ3	1.50 深 0.1			1.50 深 0.1		



RESTRICTIONS ON PRODUCT USE

- The information contained herein is subject to change without notice.
- BYD Microelectronics Co., Ltd. (short for BME) exerts the greatest possible effort to ensure high quality and reliability. Nevertheless, semiconductor devices in general can malfunction or fail due to their inherent electrical sensitivity and vulnerability to physical stress. It is the responsibility of the buyer, when utilizing BME products, to comply with the standards of safety in making a safe design for the entire system, including redundancy, fire-prevention measures, and malfunction prevention, to prevent any accidents, fires, or community damage that may ensue. In developing your designs, please ensure that BME products are used within specified operating ranges as set forth in the most recent BME products specifications.
- The BME products listed in this document are intended for usage in general electronics applications (personal equipment, office equipment, domestic appliances, etc.). These BME products are neither intended nor warranted for usage in equipment that requires extraordinarily high quality and/or reliability or a malfunction or failure of which may cause loss of human life or bodily injury ("Unintended Usage"). Unintended Usage include atomic energy control instruments, airplane or spaceship instruments, transportation instruments, traffic signal instruments, combustion control instruments, medical instruments, all types of safety devices, etc.. Unintended Usage of BME products listed in this document shall be made at the customer's own risk.
- BME is not responsible for any problems caused by circuits or diagrams described herein whose related industrial properties, patents, or other rights belong to third parties. The application circuit examples explain typical applications of the products, and do not guarantee the success of any specific mass-production design.