

# AQM

## 参数规格

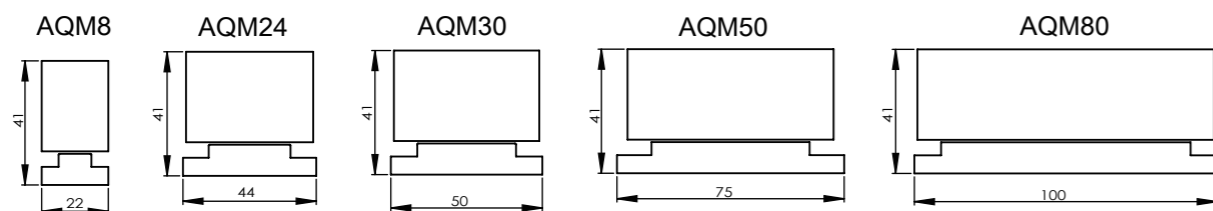

型号		AQM8-B1	AQM24-B1	AQM30-B1	AQM30-B2	AQM50-B1	AQM50-B2	AQM80-B1	AQM80-B2
性能参数	单位	串联	串联	串联	并联	并联	并联	串联	并联
持续推力 @100°C	N	20.3	60.8	75.9	151.9	126.6	253.1	202.5	405.0
峰值力	N	51.0	153.1	191.4	382.7	318.9	637.9	510.3	1020.6
力常数	N/Arms	8.1	24.3	30.4	30.4	50.6	50.6	81.0	81.0
反电势常数	Vpeak/(m/s)	6.6	19.8	24.8	24.8	41.3	41.3	66.1	66.1
电机常数	N/Sqrt(W)	3.6	8.7	10.1	14.4	14.3	20.2	19.1	26.9
终端电阻	Ω	3.3	5.2	6.0	3.0	8.4	4.2	12.0	6.0
终端电感	mH	26.0	41.3	47.1	23.5	66.2	33.1	94.9	47.5
电气时间常数	ms	7.9	7.9	7.9	7.9	7.9	7.9	7.9	7.9
持续电流@100°C	Arms	2.5	2.5	2.5	5.0	2.5	5.0	2.5	5.0
峰值电流	Arms	9.0	9.0	9.0	18.0	9.0	18.0	9.0	18.0
持续热功率@100°C	W	30.9	49.2	56.0	112.0	78.8	157.6	113.0	225.9
最高线圈温度	°C	100.0	100.0	100.0	100.0	100.0	100.0	100.0	100.0
热耗散常数	W/°C	0.4	0.7	0.7	1.5	1.1	2.1	1.5	3.0
最高母线电压	Vdc	600.0	600.0	600.0	600.0	600.0	600.0	600.0	600.0
电磁周期	mm	30.0	30.0	30.0	30.0	30.0	30.0	30.0	30.0
齿槽力(峰峰值)	N	0.5	1.5	1.9	6.5	3.1	10.8	5.0	17.3
磁吸引力	N	74.7	224.0	280.0	560.0	466.6	933.3	746.6	1493.2

注：除尺寸外，所有参数浮动为 ±10%。

# AQM

## 电机线圈/磁轨

### 电机线圈

型号	尺寸	长度(mm)	质量 (Kg)
AQM8	B1	133	0.44
AQM24	B1	133	0.83
AQM30	B1	133	0.95
	B2	268	1.91
AQM50	B1	133	1.35
	B2	268	2.71
AQM80	B1	133	1.94
	B2	268	3.91

### 电机磁轨

型号	尺寸	长度 (mm)	质量 (Kg)
AQM8	TL180	180	0.24
	TL300	300	0.40
	TL420	420	0.56
AQM24	TL180	180	0.48
	TL300	300	0.81
	TL420	420	1.13
AQM30	TL180	180	0.55
	TL300	300	0.92
	TL420	420	1.28
AQM50	TL180	180	0.83
	TL300	300	1.38
	TL420	420	1.92
AQM80	TL180	180	1.10
	TL300	300	1.84
	TL420	420	2.56

# AQM

■ 系列尺寸

## ■ AQM8-B1

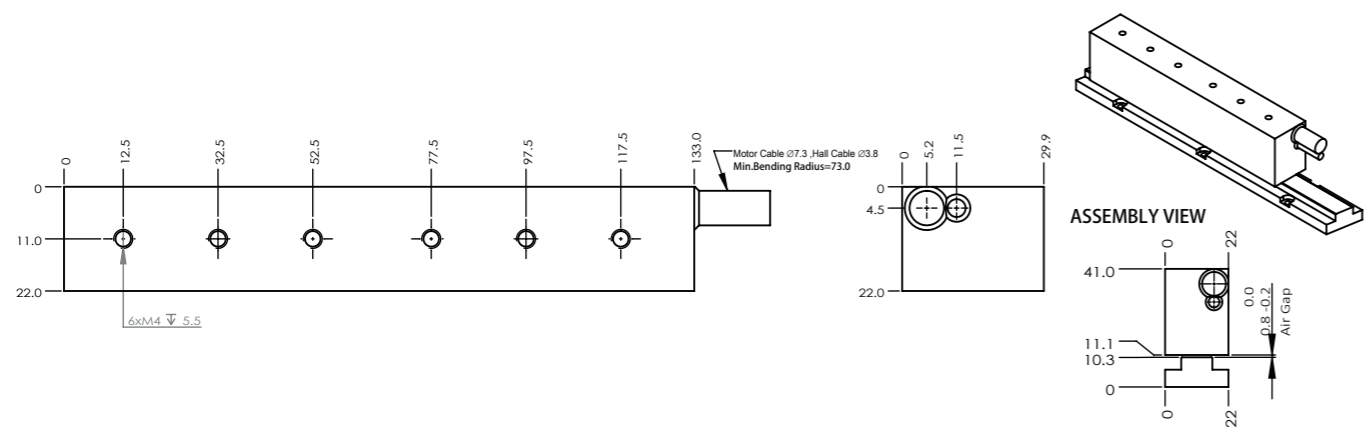

## ■ AQM8

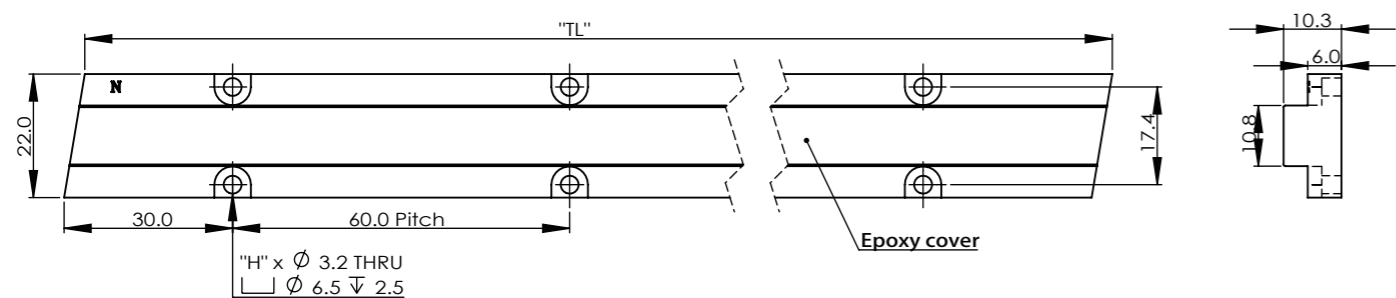

磁轨 P / N:	磁轨长度 "TL"	孔数 "H"
AQM8-TL180-E	180	6
AQM8-TL300-E	300	10
AQM8-TL420-E	420	14

# AQM

■ 系列尺寸

## ■ AQM24-B1

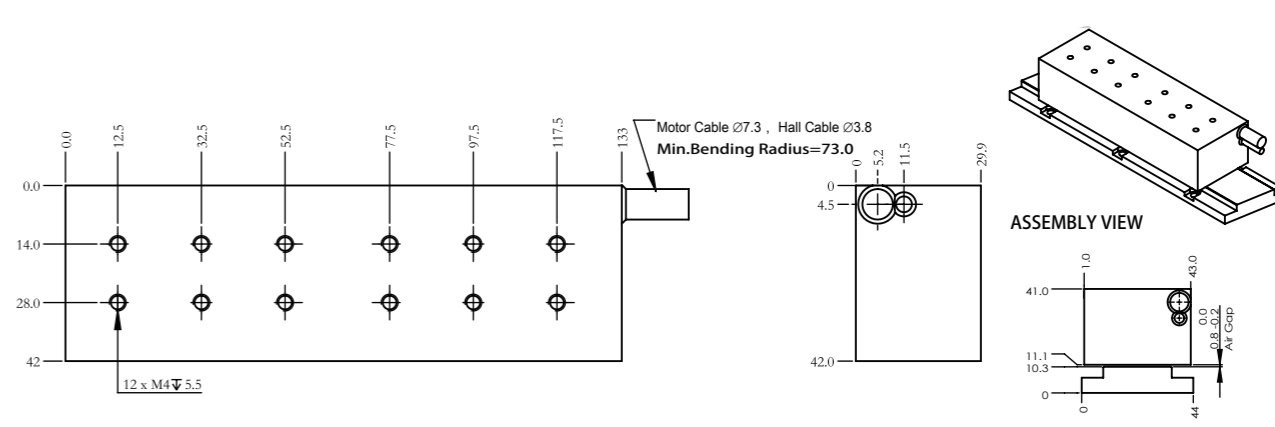

## ■ AQM24

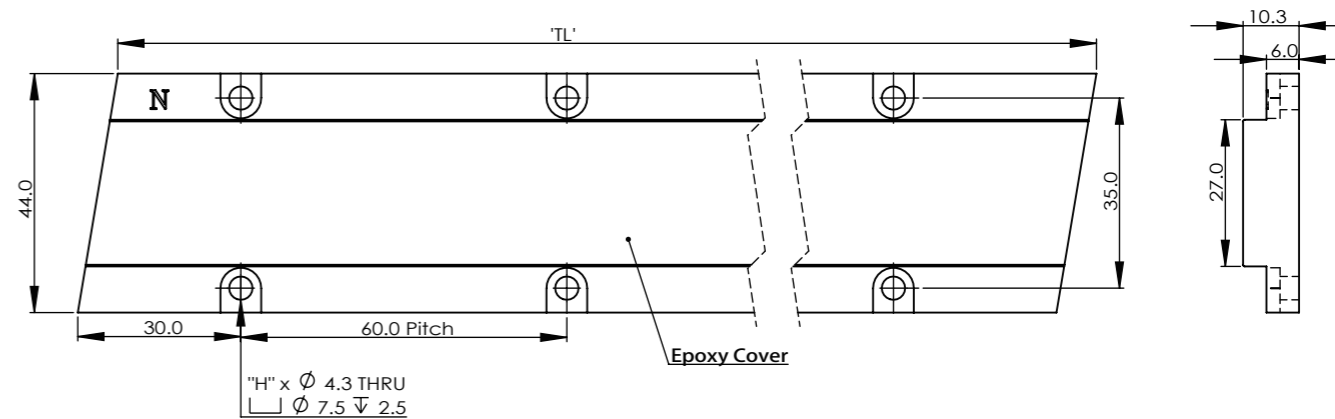

磁轨 P / N:	磁轨长度 "TL"	孔数 "H"
AQM24-TL180-E	180	6
AQM24-TL300-E	300	10
AQM24-TL420-E	420	14

# AQM

## 系列尺寸

### AQM30-B1

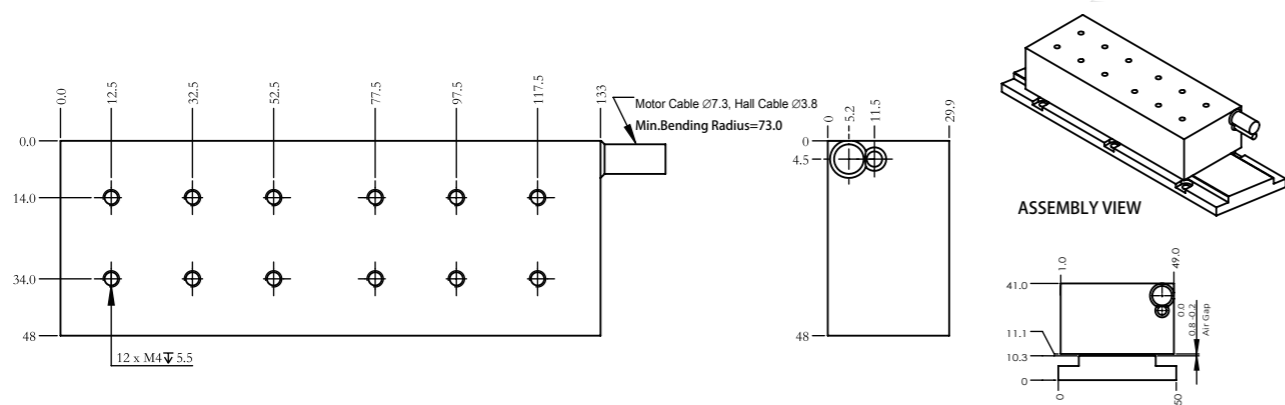

### AQM30-B2

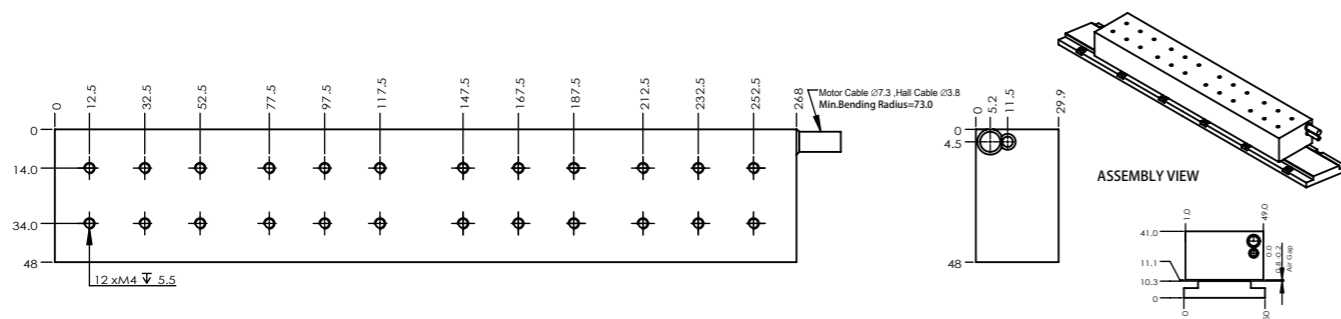

## 磁轨

# AQM

### AQM30

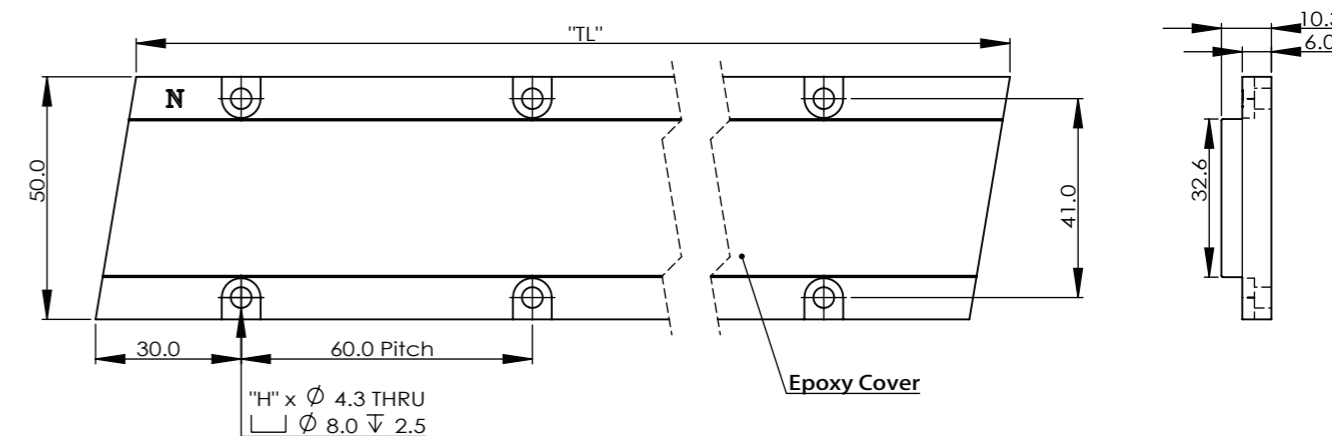

磁轨 P / N:	磁轨长度 "TL"	孔数 "H"
AQM30-TL180-E	180	6
AQM30-TL300-E	300	10
AQM30-TL420-E	420	14

# AQM

■ 系列尺寸

■ 磁轨

# AQM

## AQM50-B1

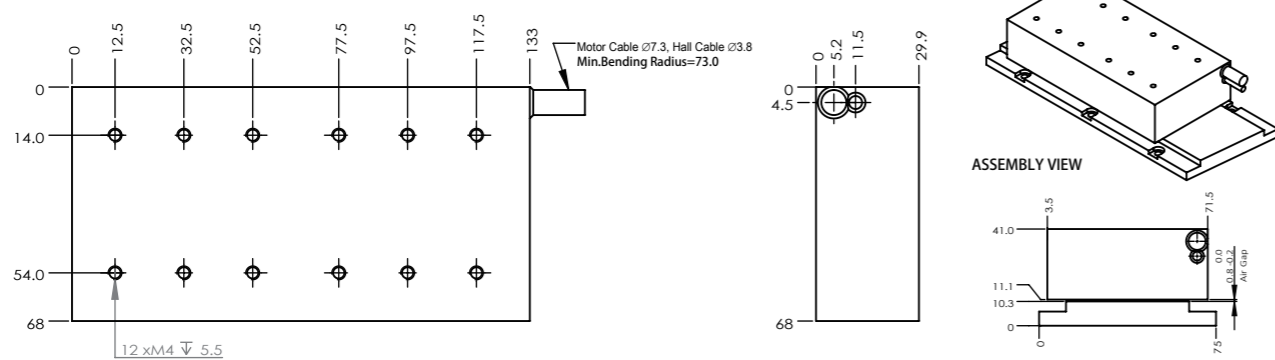

## AQM50

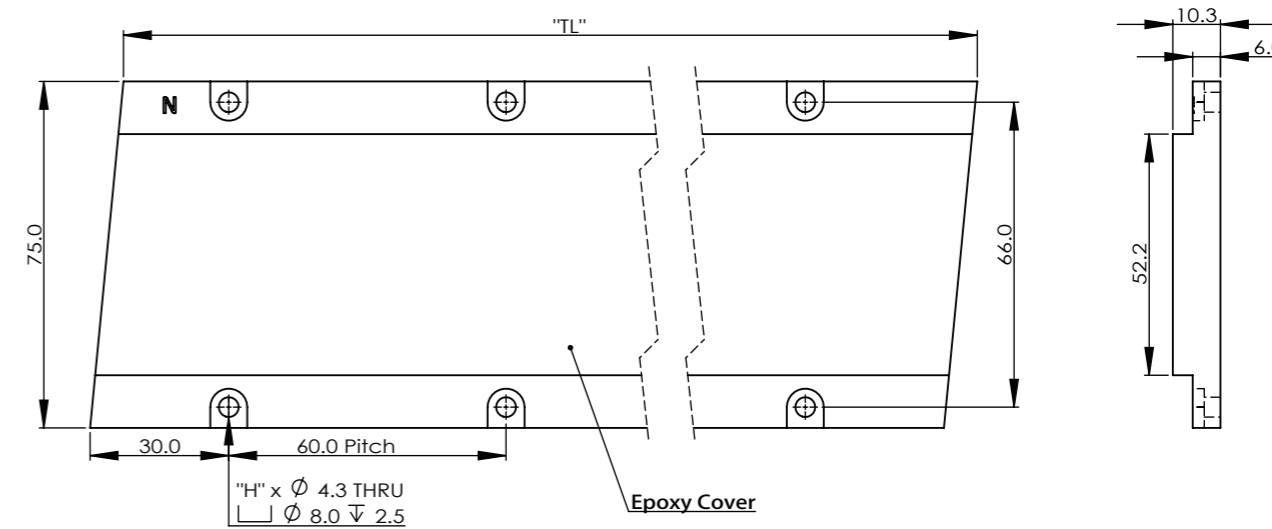

## AQM50-B2

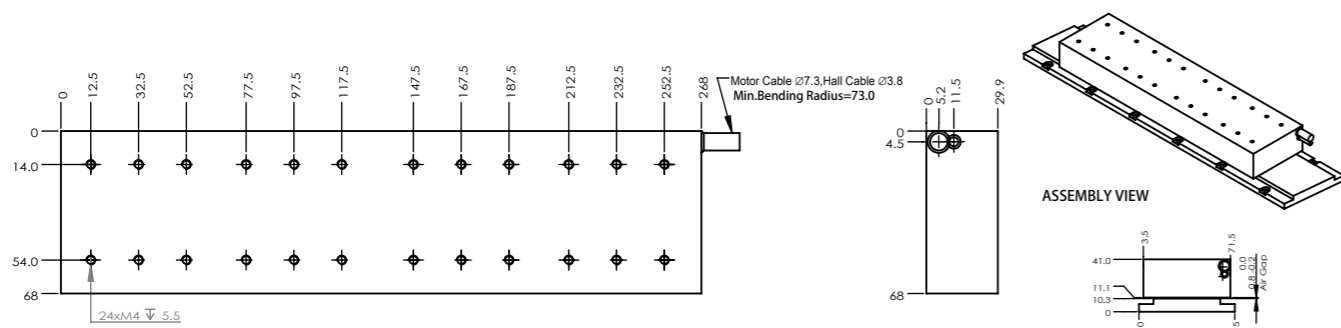

磁轨 P / N:	磁轨长度 "TL"	孔数 "H"
AQM50-TL180-E	180	6
AQM50-TL300-E	300	10
AQM50-TL420-E	420	14

# AQM

## ■ 系列尺寸

### ■ AQM80-B1

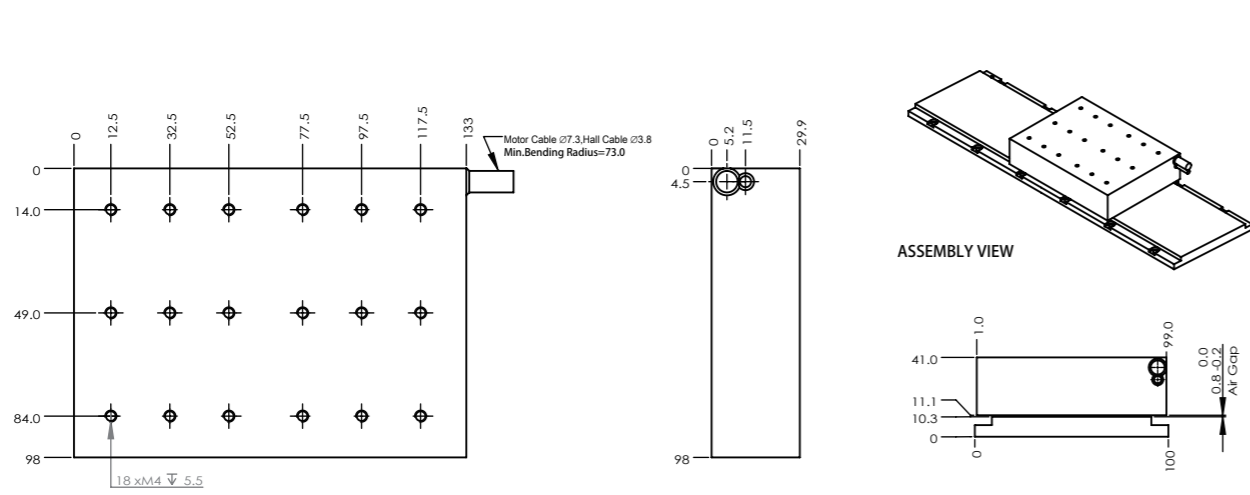

### ■ AQM80-B2

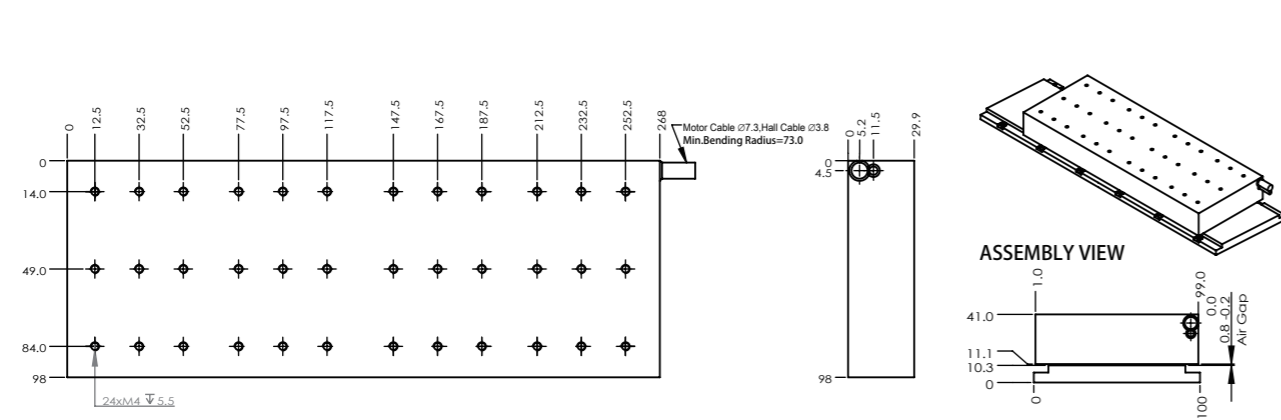

## ■ 磁轨

# AQM

### ■ AQM80

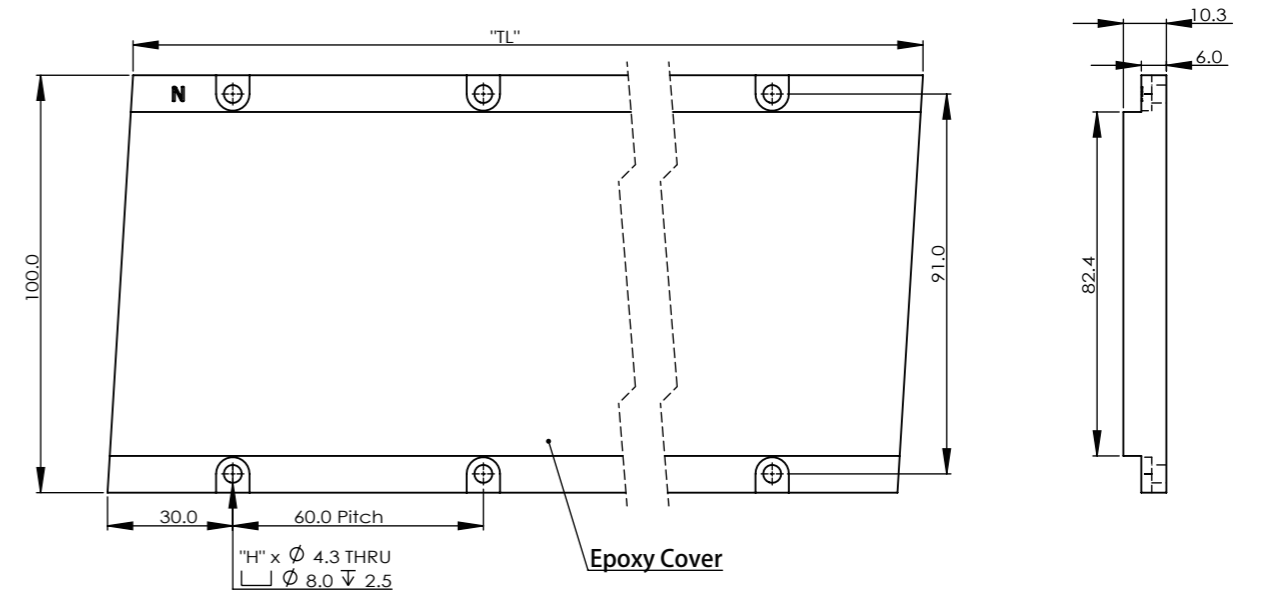

磁轨 P / N:	磁轨长度 "TL"	孔数 "H"
AQM80-TL180-E	180	6
AQM80-TL300-E	300	10
AQM80-TL420-E	420	14

# AQM

## 订购规则



### 线圈

**AQM30-B1-J-H9D-3.0-FB**

#### 型号

AQM8/AQM24/AQM30  
AQM50/AQM80

#### 尺寸

B1/B2

#### 热传感器

J = 温控开关 (标准配置), K = PT100 (RTD)  
K4 = PTC 热敏电阻, KTY81/121  
K5 = RTD, PT1000 温度传感器

#### 磁环选项

空格<sup>3</sup>, FB<sup>4</sup>

#### 电缆长度 (m)

3.0

#### 霍尔传感器选配及出线类型

空格<sup>1</sup>, H9D<sup>2</sup>



### 磁轨

**AQM30-TL420-E**

#### 型号

AQM30

#### 覆盖类型

E<sup>5</sup>

#### 磁轨长度

TL80E/ TL200E/ TL400E

- 1 空格 = 带有内置霍尔传感器, 霍尔电缆终端头为飞线 (标准配置)
- 2 H9D = 带有内置霍尔传感器, 霍尔电缆终端头为9-Pins D-Sub 接头
- 3 空格 = 电机电缆终端头为飞线 (标准配置)
- 4 FB = 电机电缆终端头带有磁环
- 5 E = 环氧树脂覆盖

## 直流母线电压 = 310 Vdc

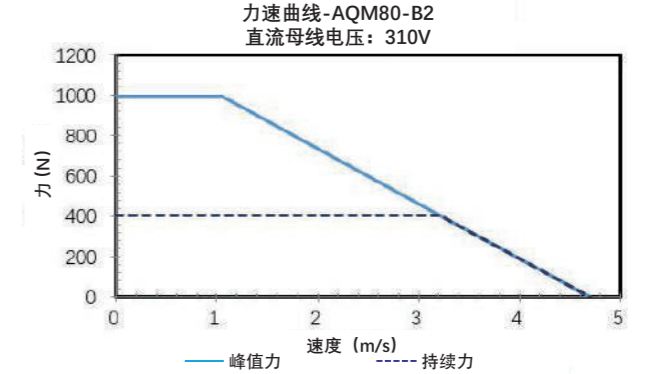
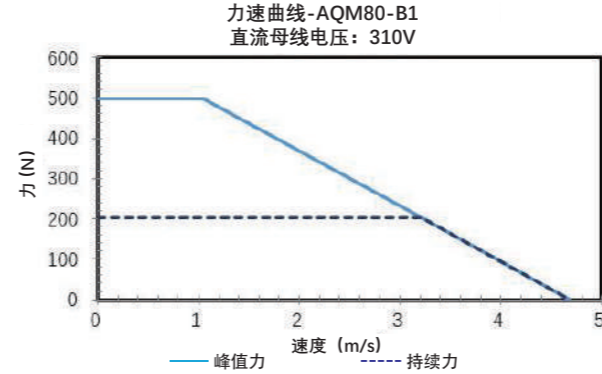
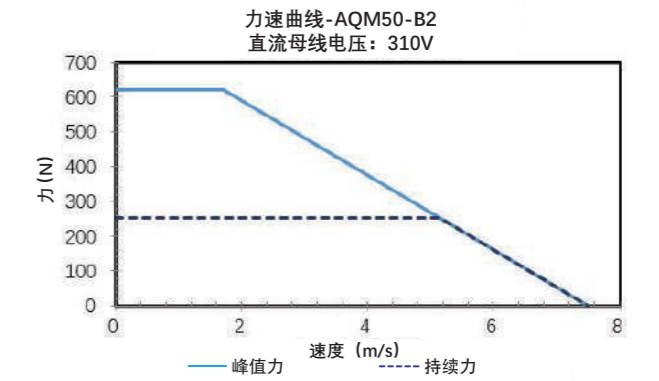
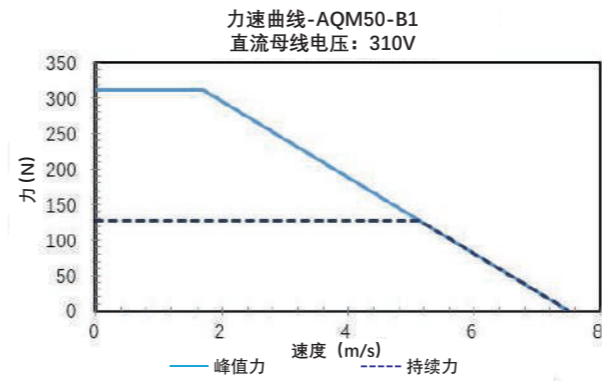
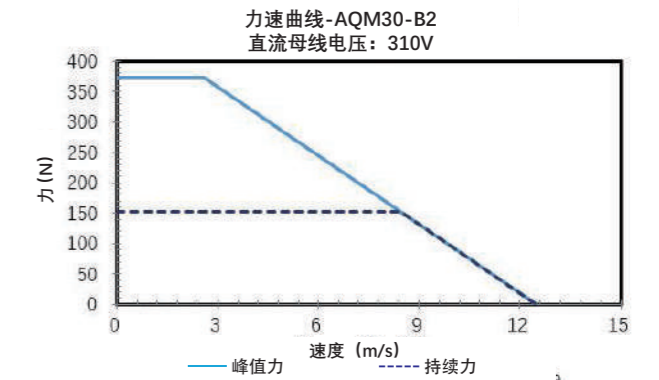
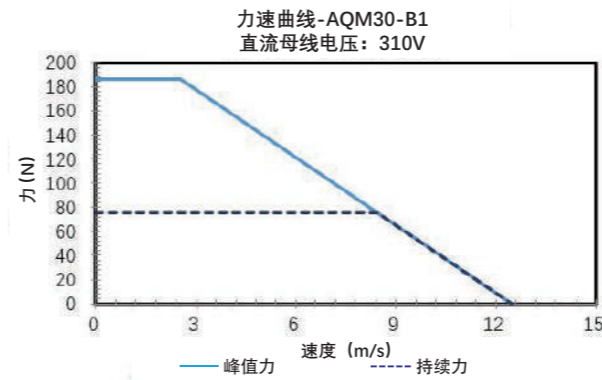
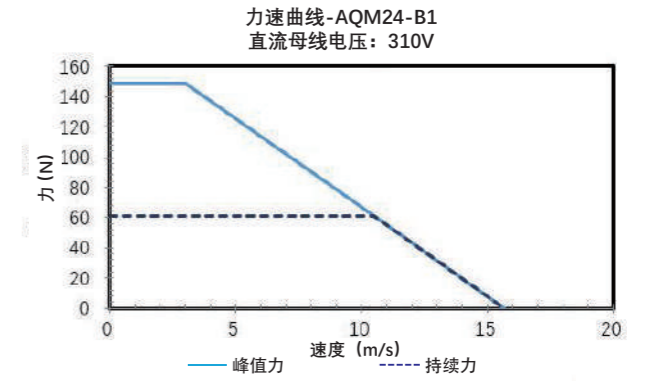
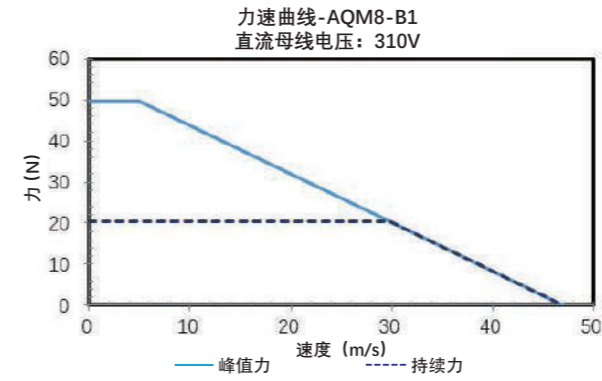

直流母线电压 = 600 Vdc

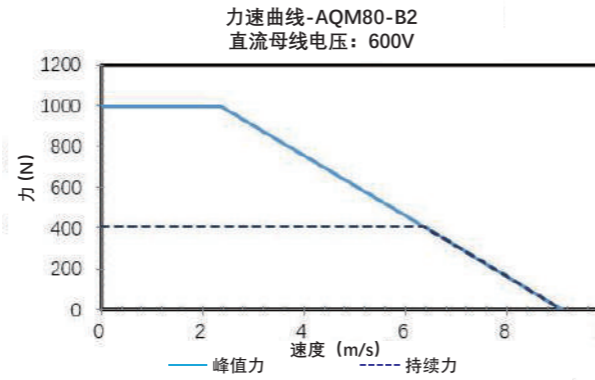
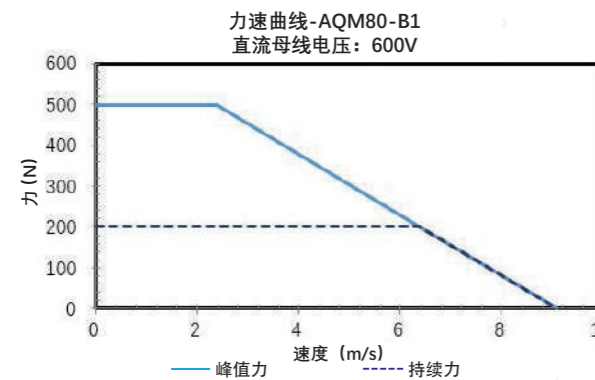
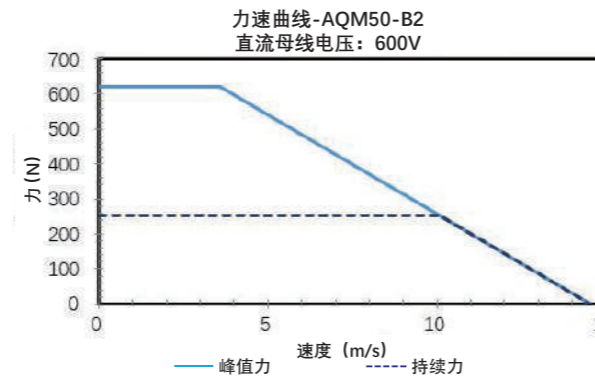
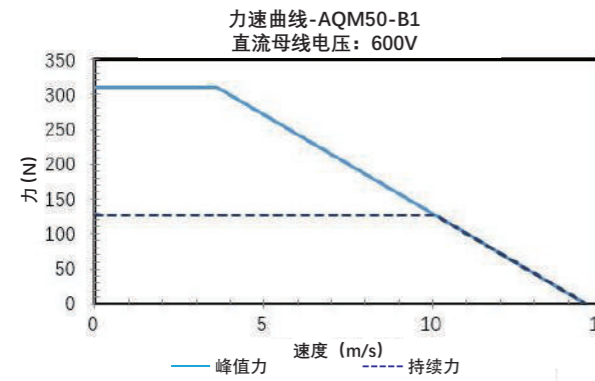
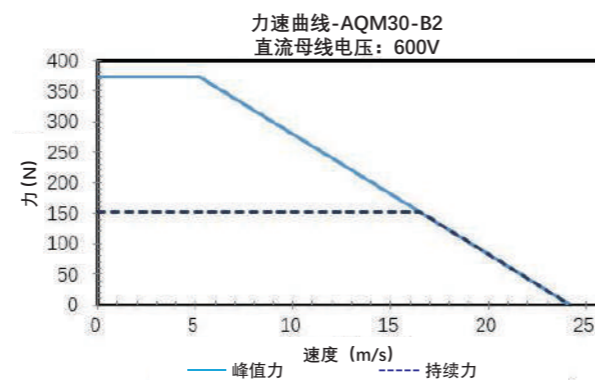
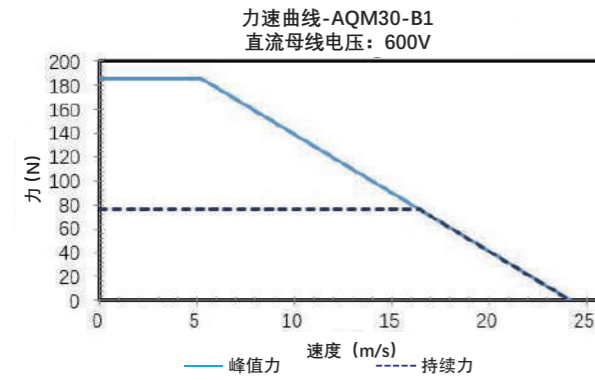
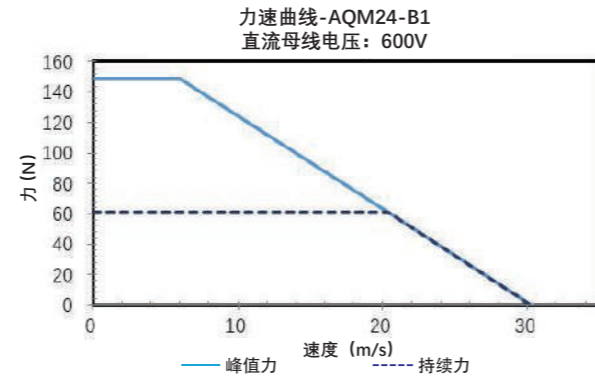
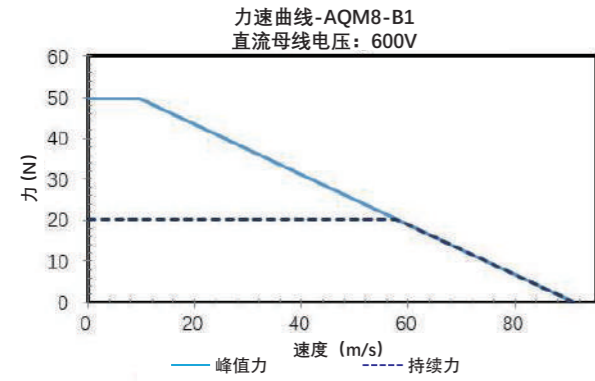

电机和霍尔线接线图

AQM

