

Beckhoff Lightbus Coupler BK2000

valid for all BK2xxx bus coupler

**Technical Documentation
2006-11-27
Version 1.4**

BECKHOFF

Contents

1. Foreword	3
Notes on the documentation	3
Liability Conditions	3
Delivery conditions	3
Copyright	3
Safety Instructions	4
State at Delivery	4
Description of safety symbols	4
2. Basic information	5
The Beckhoff bus terminal system	5
The interfaces	7
Power supply	7
Power supply to the power contacts	7
Power contacts	7
Field bus connection	8
Configuration interface	8
K-bus contacts	8
Supply isolation	8
The operating modes of the bus coupler	9
Mechanical construction	10
The peripheral data in the process image	12
Starting operation and diagnostics	15
3. Beckhoff-Lightbus coupler BK2000	17
Presentation of the Beckhoff-Lightbus system	17
4. Annex	24
Example: combination of a process image in the bus coupler	24
Examples S2100 Setup Digital Terminals	26
Representation of the analog signals in the process image	26
5. Support and Service	30
Beckhoff's branch offices and representatives	30
Beckhoff Headquarters	30

Foreword

Notes on the documentation

This description is only intended for the use of trained specialists in control and automation engineering who are familiar with the applicable national standards. It is essential that the following notes and explanations are followed when installing and commissioning these components.

Liability Conditions

The responsible staff must ensure that the application or use of the products described satisfy all the requirements for safety, including all the relevant laws, regulations, guidelines and standards. The documentation has been prepared with care. The products described are, however, constantly under development. For that reason the documentation is not in every case checked for consistency with performance data, standards or other characteristics. None of the statements of this manual represents a guarantee (Garantie) in the meaning of § 443 BGB of the German Civil Code or a statement about the contractually expected fitness for a particular purpose in the meaning of § 434 par. 1 sentence 1 BGB. In the event that it contains technical or editorial errors, we retain the right to make alterations at any time and without warning. No claims for the modification of products that have already been supplied may be made on the basis of the data, diagrams and descriptions in this documentation.

Delivery conditions

In addition, the general delivery conditions of the company Beckhoff Automation GmbH apply.

Copyright

© This documentation is copyrighted. Any reproduction or third party use of this publication, whether in whole or in part, without the written permission of Beckhoff Automation GmbH, is forbidden.

Safety Instructions

State at Delivery

All the components are supplied in particular hardware and software configurations appropriate for the application. Modifications to hardware or software configurations other than those described in the documentation are not permitted, and nullify the liability of Beckhoff Automation GmbH.

Description of safety symbols

The following safety symbols are used in this documentation. They are intended to alert the reader to the associated safety instructions..



Danger

This symbol is intended to highlight risks for the life or health of personnel.



Attention

This symbol is intended to highlight risks for equipment, materials or the environment.



Note

This symbol indicates information that contributes to better understanding.

Basic information

The Beckhoff bus terminal system

Up to 64 bus terminals

*each with 2 I/O channels
for any form of signal*

The bus terminal system is the universal connecting link between a fieldbus system and the sensor/actor level. A unit consists of a bus coupler, which is the interface to the fieldbus, and up to 64 electronic terminals, of which the last is an end terminal. Terminals, each with two I/O channels, are available for any form of technical signal and can be combined as desired. The various types of terminal are all constructed in the same way, so that the planning costs are kept extremely low. The height and depth of the construction are calculated for compact terminal cabinets.

*Decentralized wiring of
the I/O level*

IPC as control unit

Fieldbus technology makes it possible to use compact control architectures. The I/O level does not need to be taken right up to the control unit. Sensors and actors can be connected decentrally with minimal lengths of cable. You can position the control unit at any convenient location in the installation. Using an industrial PC as control unit makes it possible to implement the operating and monitoring element as part of the control hardware, so the control unit can be located on an operating desk, control point or similar. The bus terminals constitute the decentralized input/output level of the control unit in the switch cabinet and its subordinate terminal cabinets. As well as the sensor/actor level, the power unit of the equipment is also controlled via the bus system. The bus terminal replaces a conventional terminal as the cabling level in the switch cabinet; the switch cabinet can be made smaller.

*Bus couplers for all current
bus systems*

The Beckhoff bus terminal system combines the advantages of a bus system with the functionality of compact terminals. Bus terminals can be used on all current bus systems and serve to reduce the diversity of parts in the control unit, while behaving like the conventional standard units for the relevant bus system and supporting the entire range of functionality of the bus system.

Standard C rail assembly

The simple and compact assembly on a standard C rail, and the direct cabling of actors and sensors without cross connections between the terminals, serve to standardize the installation, as does the uniformly designed labeling.

The small size and great flexibility of the bus terminal system mean that you can use it anywhere that you could use a terminal and use any type of connection – analog, digital, serial or direct sensors.

Modularity

The modular construction of the terminal row, using bus terminals with various functions, limits the number of unused channels to at most one per function. Two channels to a terminal is the optimum solution for the number of unused channels and the cost per channel. The possibility of using power input terminals to provide separate power supplies also helps to minimize the number of unused channels.

Display of channel status

The integrated light-emitting diodes close to the sensor/actor indicate the status of each channel.

The K-bus

End terminal

The K-bus is the path taken by data within the terminal row. The bus coupler carries the K-bus through all the terminals by means of six contacts on the side walls of the terminals, and the end terminal terminates the K-bus. The user does not need to know anything about the function of the K-bus or the internal operation of terminals and bus couplers. There are numerous software tools available which provide for convenient planning, configuration and operation.

Power input terminals

Three power contacts pass the operating power to the following terminals.

for separately powered groups

You can use power input terminals to subdivide the terminal row as desired into groups, each with a separate power supply. These power input terminals are not taken into account for addressing the terminals, you can insert them at any position along the terminal row.

You can install up to 64 terminals on a terminal row, including power input terminals and the end terminal.

The principle of the bus terminal

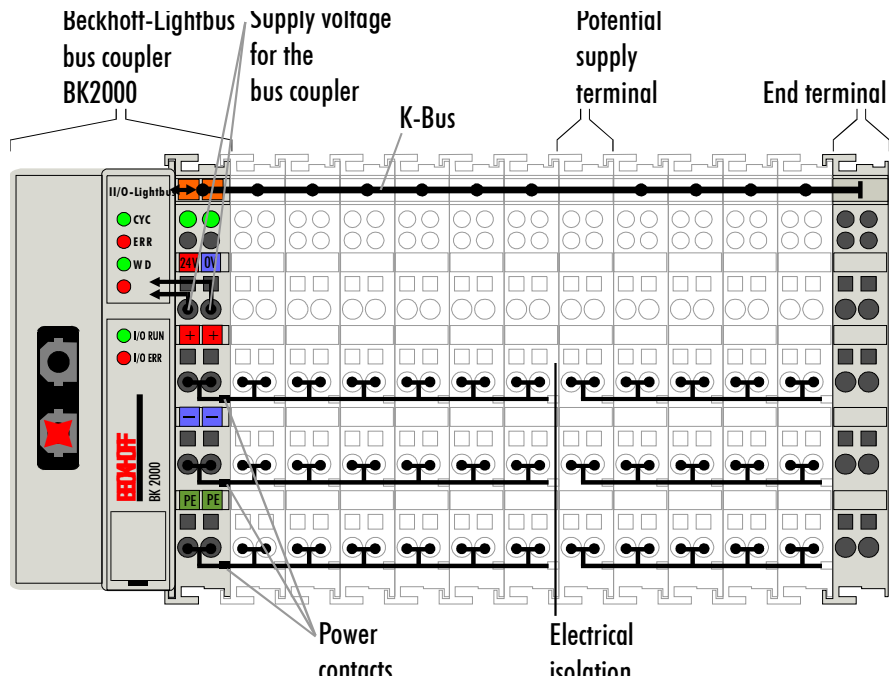

Bus couplers for various fieldbus systems

You can use a variety of bus couplers to attach the electronic terminal row quickly and easily to the various fieldbus systems, and you can also subsequently convert to a different fieldbus system. The bus coupler deals with all the necessary monitoring and control tasks for operating the attached bus terminals, indeed all the operation and configuration of the bus terminals is carried out via the bus coupler. The fieldbus, K-bus and I/O level are electrically isolated.

If the exchange of data across the fieldbus is temporarily interrupted, logic states are preserved, digital outputs are cleared and analog outputs revert to a reset value which can be individually configured for each output when the equipment is set up. The default for the analog outputs is 0V or 0mA. Digital outputs assume an inactive state. The bus couplers' timeouts correspond to the usual times for the field bus system. When changing over to a different bus system, pay attention to the change in timeouts in the event of larger-scale bus system cycle times.

The interfaces

There are six ways of making a connection to a bus coupler. These interfaces are designed as plug connections and spring terminals.

The Beckhoff-Lightbus – coupler BK2000

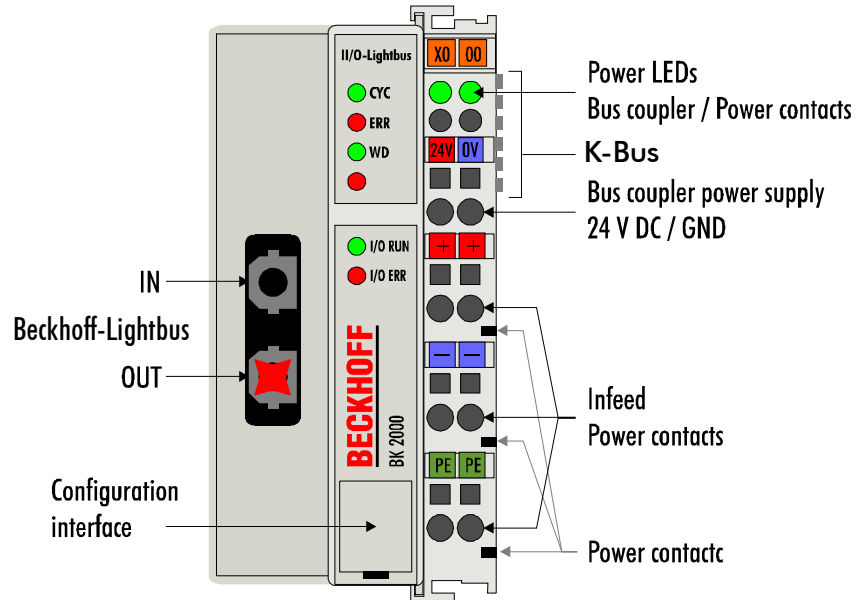

24 V DC on the topmost terminals "24 V" and "0 V"

Power supply

The bus couplers need an operating power of 24 V DC which is connected via the topmost spring terminals, labeled "24 V" and "0 V". This power supply serves not only the electronic components of the bus coupler but (via the K-bus) also the bus terminals. The power supply of the bus coupler circuitry and that of the K-bus are electrically isolated from the voltage of the field level.

Lower 3 terminal pairs for power input

maximum 24 V

maximum 10 A

Power supply to the power contacts

The six lower connections with spring terminals can be used to supply power to the peripherals. The spring terminals are connected in pairs to the power contacts. The power supply to the power contacts has no connection to the power supply of the bus couplers. The power input is designed to permit voltages up to 24 V. The pair-wise arrangement and the electrical connection between the feed terminal contacts makes it possible to loop through the wires connecting to different terminal points. The load on the power contact may not continuously exceed 10 A. The current capacity between two spring terminals is the same as the capacity of the connecting wires.

Spring contacts at the side

Power contacts

On the right-hand side face of the bus coupler are three spring contacts which are the power connections. The spring contacts are recessed in slots to prevent them from being touched. When a bus terminal is connected, the blade contacts on the left-hand side of the bus terminal are connected to the spring contacts. The slot and key guides at the top and bottom of the bus couplers and bus terminals ensure reliable location of the power contacts.

Beckhoff-Lightbus fiber-optic conductor ring

Beckhoff Z1000 connector

Field bus connection

There is a recessed front surface on the left-hand side. The typical Beckhoff-Lightbus connectors can be inserted here. The Beckhoff-Lightbus consists of a fiber-optic conductor ring into which the bus coupler is inserted. In doing so, the connector out of which red light emerges when the Beckhoff-Lightbus is switched on must be inserted in the top socket. In the illustration, this is marked "IN". You need a fiber-optic conductor connector type Beckhoff Z1000 for connection.

Serial interface under the front flap

Configuration interface

On the lower part of the front face you will find the standbus couplers which are fitted with an RS232 interface. The miniature plug can be attached to a PC by means of a connection cable and the configuration software KS2000. This interface enables you to configure the analog channels. You can also access the functionality of the configuration interface via the fieldbus by means of the ADS communications.

6 contacts at the side

K-bus contacts

The connections between the bus coupler and the bus terminals are effected by gold contacts at the right-hand side of the bus coupler. When the bus terminals are plugged together, these gold contacts automatically complete the connection to the bus terminals. The K-bus is responsible for the power supply to the electronic components of the K-bus in the bus terminals, and for the exchange of data between the bus coupler and the bus terminals. Part of the data exchange takes place via a ring structure within the K-bus. Disengaging the K-bus, for example by pulling on one the bus terminals, will break this circuit so that data can no longer be exchanged. However, there are mechanisms in place which enable the bus coupler to locate the interruption and report it.

*3 supply groups:
fieldbus
K-bus
peripheral level*

Supply isolation

The bus couplers operate with three independent supplies. The input power supplies the electrically isolated K-bus circuitry in the bus coupler and the K-bus itself. The power supply is also used to generate the operating power for the fieldbus.

Note: All the bus terminals are electrically isolated from the K-bus, so that the K-bus is completely electrically isolated.

Setting up the power levels in the bus terminal system

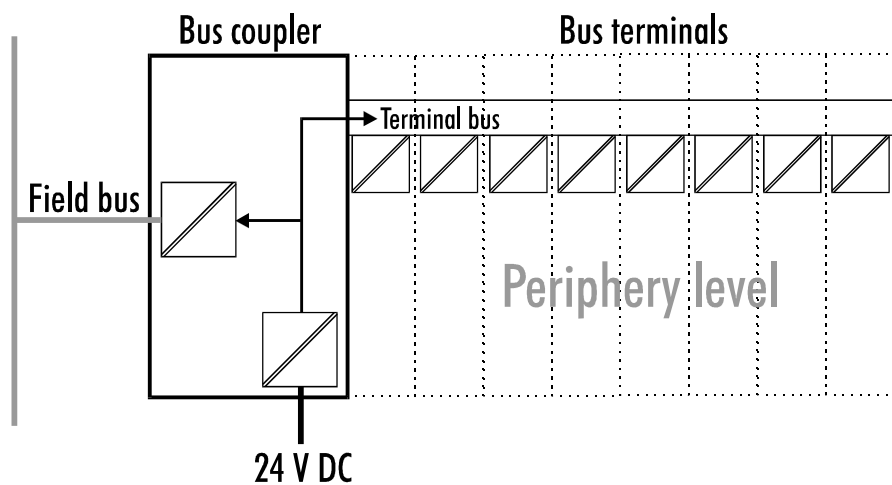

The operating modes of the bus coupler

When it is first switched on the bus coupler carries out a self-test to check the functions of its components and the communications of the K-bus, and while this is going on the red I/O LED will flash. When the self-test has been completed successfully, the bus coupler will begin to test the attached bus terminals (the “bus terminal test”) and read in the configuration from which it constructs an internal structure list, which is not accessible from outside. If an error occurs the bus coupler will enter the operating mode “STOP”. If the start-up sequence is completed without errors the bus coupler will enter the mode “fieldbus start”.

Start-up behavior of the bus coupler

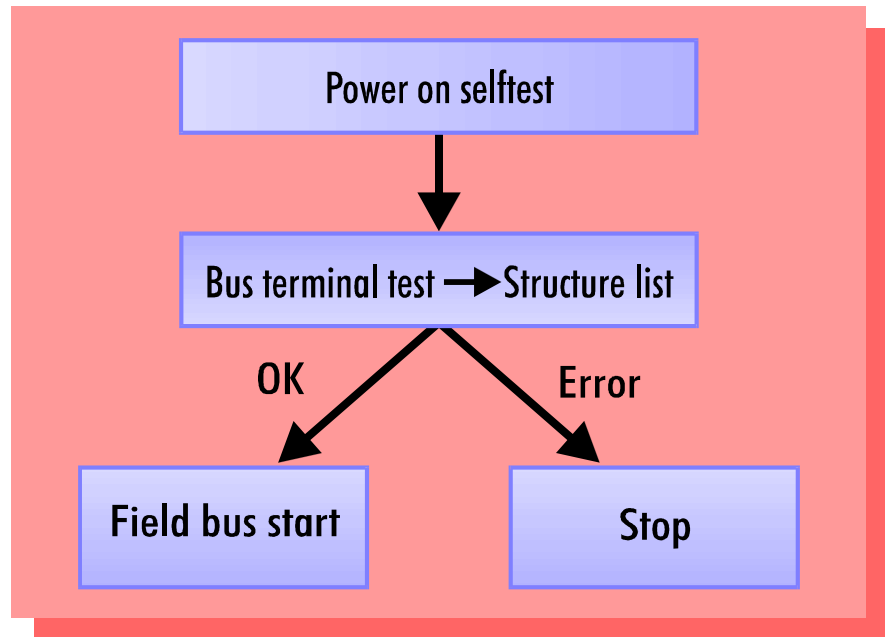

The bus coupler can only be returned to normal operation after fault clearance by restarting the system.

Mechanical construction

The Beckhoff bus terminal system is remarkable for its compact construction and high degree of modularity. When you design the installation you will need to plan for one bus coupler and some number of bus terminals. The dimensions of the bus couplers do not depend on the fieldbus system. The clear dimensions of the bus coupler are not exceeded thanks to the use of fiber-optic cable with the Z1000 connectors.

Dimensions of a bus coupler

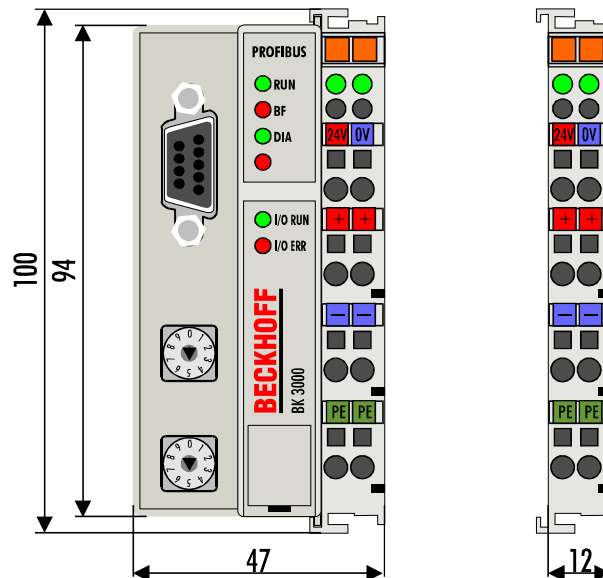

The overall width of the construction is the width of the bus coupler, including the bus end terminal, plus the width of the installed bus terminals. The bus terminals are 12 mm or 24 mm wide, depending on their function. Depending on the gauge of cables used the overall height of 68 mm may be overstepped by about 5 mm to 10 mm by the cables at the front.

Assembly and connections

It takes only a slight pressure to latch the bus coupler and the various bus terminals onto a supporting 35 mm C rail and a locking mechanism then prevents the individual housings from being removed. You can remove them without effort if you first release the latching mechanism by pulling the orange tab. You should carry out work on the bus terminals and the bus coupler only while they are switched off: if you plug or unplug components while the power is on you may briefly provoke some undefined state (and, for instance, reset the bus coupler).

You can attach up to 64 bus terminals in series on the right-hand side of the bus coupler. When you assemble the components, make sure that you mount the housings so that each slot comes together with the corresponding key. You cannot make any functional connections merely by pushing the housings together along the supporting track. When they are correctly mounted there should be no appreciable gap between the adjacent housings.

The right-hand side of a bus coupler is mechanically similar to a bus terminal. There are eight connections on the top which can be used to connect to thick-wire or thin-wire lines. The connection terminals are spring loaded. You open a spring terminal by applying a slight pressure with a screwdriver or other pointed tool in the opening above the terminal and you can then insert the wire into the terminal without any obstruction. When you release the pressure the terminal will automatically close and hold the wire securely and permanently.

The connection between bus couplers and bus terminals is automatically effected by latching the components together. The K-bus is responsible for passing data and power to the electronic components of the bus terminals. In the case of digital bus terminals, the field logic receives power via the power contacts. Latching the components together has the effect that the series of power contacts constitutes a continuous power track. Please refer to the circuit diagrams of the bus terminals: some bus terminals do not loop these power contacts through, or not completely (e.g. analog bus terminals or 4-channel digital bus terminals). Each power input terminal interrupts the series of power contacts and constitutes the beginning of a new track. The bus coupler can also be used to supply power to the power contacts.

Insulation test

The power contact labeled “PE” can be used as protective earth or ground. This contact stands proud for safety reasons and can carry short-circuit currents of up to 125A. Note that in the interests of electromagnetic compatibility the PE contacts are capacitively connected to the supporting track. This may lead to spurious results and even damage to the terminal when you test the insulation (e.g. insulation test for breakdown using a 230V mains supply to the PE line). You should therefore disconnect the PE line on the bus coupler while you carry out insulation tests. You can disconnect other power supply points for the duration of the test by drawing the power supply terminals out from the remaining row of terminals by at least 10mm. If you do this, there will be no need to disconnect the PE connections.

PE power contacts

The protective earth power contact (“PE”) may not be used for any other connections.

Electrical data

Lightbus couplers may have different configuration levels. The electrical data specific to the fieldbus is listed in the appropriate chapter. The following data distinguishes between the standard version and the economy version (BK2000 and BK2010). Either version is fully compatible to the Beckhoff-Lightbus, but the economy version has only a limited number of I/O points, which is why it permits you to attach only digital inputs and outputs.

Technical data	Beckhoff-Lightbus coupler BK2000	Economy coupler BK2010
Voltage supply	24 V, + / - 10%	
Input current	105 mA typical 900 mA max.	85 mA typical 300 mA max.
Output current K-bus	1.75 A max.	0.5 A max.
Supply isolation	500 Veff (K-bus / supply voltage)	
Number of bus terminals	64	
Digital peripheral signals	256 inputs and outputs	256 inputs and 256 outputs
Analog peripheral signals	128 inputs and outputs	--
Peripheral bytes	512 input and 512 output bytes	32 input and 32 output bytes
Configuration interface	Available for KS2000	
Baud rates	2,5 MBaud	
Voltage power contact	24V DC / AC	
Current load power con.	10 A	
Max. voltage capacity	500 Veff (power contact / supply voltage)	
Weight approx.	150g	130g
Operating temperature	0 °C ... +55 °C	
Storage temperature	-25 °C ... +85 °C	
Relative humidity	95% non-condensing	
Vibration /shock resistance	according to IEC 68-2-6 / IEC 68-2-27	
Interference resistance. Burst / ESD	according to EN 61000-4-4/ EN 61000- 4-, limit EN 50082-2-4	
Orientation for mounting	any	
Type of fuse	IP20	

The peripheral data in the process image

The bus coupler features different memory areas that possess a size of 256 words each. Targeted access to any chosen memory cell is possible by way of the Beckhoff-Lightbus telegrams. Two relevant areas of the memory can be distinguished by means of the control and status byte in the Beckhoff-Lightbus telegram and can be addressed separately. The value in the control and status byte for triggering a bus coupler update is 10hex and, to do this, the data byte must contain the constant 80hex. Access to the data in the bus coupler is then possible. To do this, the control and status byte contains the value 30hex. With one access operation, two bytes can be written and two bytes can be simultaneously read. You will find an exact description in the following chapters.

After switching on, the bus coupler determines the configuration of the inserted input/output terminals. The affiliations between physical slots of the input/output channels and the addresses of the process image are established automatically by the bus coupler.

The bus coupler creates an internal allocation list in the input/output channels that have a specific position in the bus coupler's process image. Here, a distinction is made between inputs and outputs and between bit-oriented (digital) and byte-oriented (analog or complex) signal processing.

Two groups are generated, each one only with inputs or only with outputs. In one group, the byte-oriented channels are at the lowest address in ascending order followed by the bit-oriented channels.

Digital signals (bit-oriented)

Digital signals are bit-oriented. This means that one bit of the process image is assigned to each digital channel. The bus coupler sets up a block of memory containing the current input bits and arranges to immediately write out the bits from a second block of memory which belongs to the output channels.

The precise assignment of the input and output channels to the process image of the control unit is explained in detail in the Appendix by means of an example.

Analog signals (byte-oriented)

Processing of the analog signals is fundamentally byte-oriented. The analog input and output values are stored in the memory in a two-byte notation. The values are represented as "SIGNED INTEGER". The numeric value "0" stands for the input/output value "0V", "0mA" or "4mA". In the default setting, the maximum value of the input/output value is represented by "7FFF" hex. The intermediate values are accordingly proportional with respect to one another. The area with a resolution of 15 bits is not realized with every input or output stage. In the event of an actual resolution of 12 bits, the last three bits are of no effect for outputs and, for inputs, they are read as "0". Each channel also has a control and status byte. The control and status byte is the most significant byte in the most significant word. An analog channel is represented with four bytes in the process image, three bytes of which are used. (In the BK3000 and BK4000, only two bytes are occupied for each analog channel in the process image of the corresponding bus system. The control and status bytes of the bus terminals can also be inserted by reconfiguration in the bus coupler and in the bus terminals.)

Special signals and interface

The BK2000 supports bus terminals with further interfaces such as RS232, RS485, incremental encoders or others. These signals can be controlled just like the above-mentioned analog signals. To some extent, a bit width of 16 does not suffice for the special signals. The bus coupler is capable of supporting any byte width. With regard to accessing these values, please ensure that data consistency is safeguarded. That is to say, do not send any "update" command between access operations and do not switch the bus coupler to "freewheeling" mode.

Default assignment of inputs and outputs to the process image

When the bus coupler is first switched on it determines the number of attached bus terminals and sets up a list of assignments. This list distinguishes between analog channels and digital channels and between input and output; which are grouped separately. The assignments begin immediately to the left of the bus coupler. The software in the bus coupler creates the assignment list by collecting the entries for the individual channels one at a time, counting from left to right. These assignments distinguish four groups:

	Function type of the channel	Assignment level
1.	Analog outputs	byte-wise assignment
2.	Digital outputs	bit-wise assignment
3.	Analog inputs	byte-wise assignment
4.	Digital inputs	bit-wise assignment

Complex multi-byte signal bus terminals are represented as analog inputs or outputs

Overview of the subdivision of the process image in the bus coupler:

Output data in the bus coupler

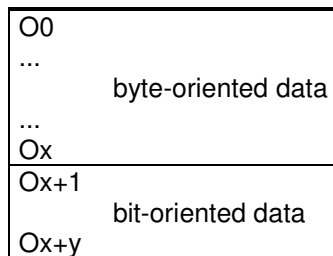

Input data in the bus coupler

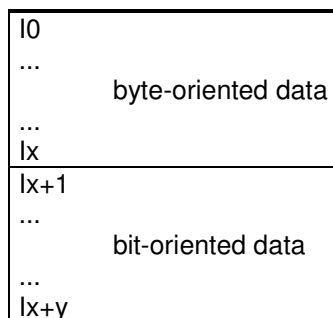

The path from the I/Os to the Beckhoff-Lightbus process image

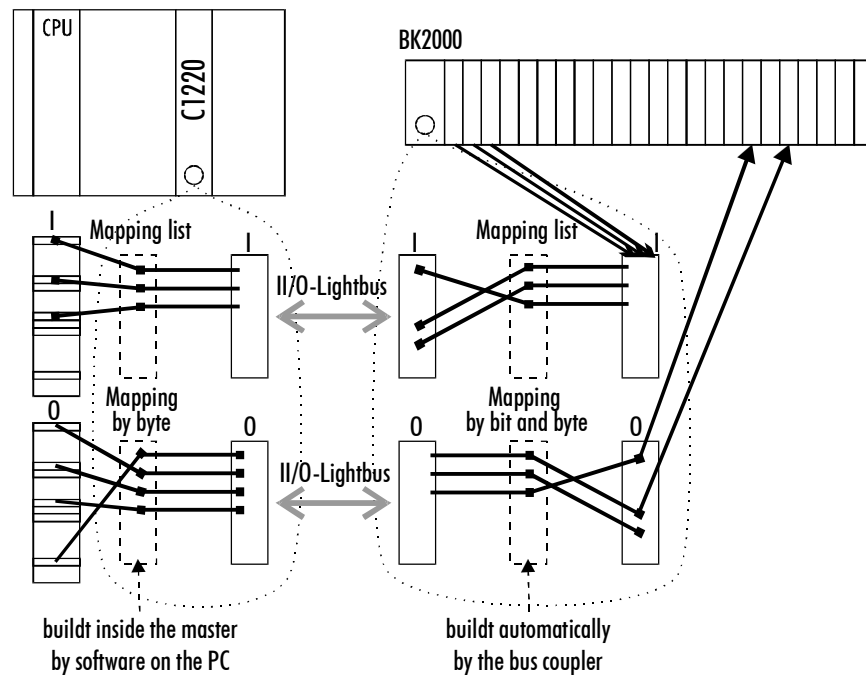

The bus coupler creates for itself internal allocations of the peripheral data to the process image. By means of the KS2000 software, the allocation list can be modified on a PC. Placeholders are inserted and offsets of the data in the process image are realized. The figure shows the subsequent "1:1 transfer" via the field bus. The peripheral data can be allocated to the memory addresses of the controller in the master.

Data is referred to as being consistent when it is transferred and processed coherently in relation to its content.

This is particularly important with regard to

1. the high and the low bytes of an analog value (word consistency over one or several word(s)),
2. the control/status byte and the affiliated parameter word for access to the registers.

Data consistency

Fundamentally, data consistency in connection with the periphery and controller, and depending on the bus master used, is only ensured for one byte or one word. That is to say, the bits belonging to a byte or a word are read together or are output together. Byte-by-byte consistency is adequate for processing digital signals. Consistency must be extended in cases when values with a length in excess of 8 bits, e.g. analog values, are transferred. Attention must be paid to the correct method of transferring the consistent data from the master of the bus system to the controller. A detailed description of the correct method can be found in the corresponding operating manual for the bus system, in particular the description of the master interfaces used. With regard to the Beckhoff-Lightbus, data consistency is ensured for the complete data block of one "CDL". In this case, the controller can only access one completely transferred data area. The Beckhoff-Lightbus telegrams are used for access to the data in the BK2000 and BK2010 bus couplers. You will find application examples in the annex.

Processing complex signals All byte-oriented signal channels such as RS232, RS485 and incremental encoder, can use byte lengths greater than two. Apart from the actual difference in length, the procedure is always comparable with that for analog signals.

Starting operation and diagnostics

The bus coupler immediately checks the connected configuration after switching on. An error-free startup is indicated by the fact that the red "I/O ERR" LED goes off. Flashing of the "I/O ERR" LED indicates an error in the area of the terminals. The error code can be determined by the frequency and quantity of flashing, thus enabling swift troubleshooting. You will find a detailed description in the chapter entitled "The diagnostic LEDs".

The diagnostic LEDs

The bus coupler has a status display consisting of two groups of LEDs. The upper group has four LEDs which indicate the mode of the installed fieldbus. The significance of these "fieldbus status LEDs" is explained in the appropriate chapters of this manual; they correspond to the usual displays for fieldbuses.

There are two more green LEDs at the top right-hand side of the bus coupler to indicate the supply voltage. The left-hand LED shows the 24V supply of the bus coupler. The right-hand LED shows the supply to the power contacts.

Local errors

Two LEDs, the "I/O LEDs", which are situated below the fieldbus status LEDs described above, are used to display the operating mode of the bus terminals and the connection to these bus terminals. The green LED lights up to indicate error-free operation, where "error-free" implies that communication with the fieldbus system is also operating correctly. The red LED flashes at two different rates to indicate a fault, whereby the specific error is encoded in the pattern of flashes, as follows.

Code of flashes

Rapid flashing	Start of the error code
First slow sequence	Type of error
Second slow sequence	Location of error

Type of error

1 flash	
2 flashes	
3 flashes	Connection to the bus terminals cannot be set up correctly
4 flashes	Break in the K-bus

Location of error

The number of pulses indicates the last bus terminal before the error. Passive bus terminals, for example an infeed terminal, are not counted.

The bus coupler does not end the flashing sequence when the error is remedied. The bus coupler's operating state: "Stop". The bus coupler can only be restarted by switching off the supply voltage.

Fieldbus errors

The field bus status LEDs indicate the operating states of the field bus. The functions of the Beckhoff-Lightbus are reflected by the "CYC", "ERR" and "WD" LEDs. The fourth LED is irrelevant.

The meanings of the first three LEDs:

CYC	The LED lights up during the length of each telegram.
ERR	is activated in the event of an errored telegram and is deactivated again after three error-free telegrams
WD	Watchdog, which lights up for 100ms after addressing of the bus coupler

BK2000 diagnostic LEDs

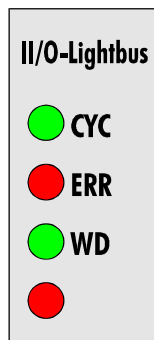

Attention must be paid to the fact that there is a connection between the green I/O LED and the field bus. The I/O LED lights up in connection with access to the internal K-bus. The green I/O LED does not light up until a trigger begins via the field bus. This means that the field bus must access the bus coupler and the controller software must clear a cyclical trigger. The green I/O LED indicates access to the internal K-bus and is reset after 100 ms.

The bus coupler queries the configuration of the bus terminals after switching on and does not exchange data with the terminals. That is to say, the red I/O LED goes off after an error-free startup without the green I/O LED having to light up. The green I/O LED does not light up until data exchange is begun via the Beckhoff-Lightbus.

CYC	ERR	WD	Meaning	Remedy
lit	off	lit	Cyclic telegrams are passing via the ring. Inputs are read and outputs are set.	
off	flashing	off	Occasional CRC error (green I/O LED lit) Inputs are read; outputs are not updated.	Fiber-optic connection damaged
off	lit	off	Bus error (physical). Errored telegrams are passing through the ring, e.g. fiber-optic line damaged or previous module malfunctioning, connector not inserted correctly.	Check: whether the fiber-optic cable is inserted whether the fiber-optic cable has a discontinuity whether previous units are operable.
off	off	off	No operating voltage, severe error; no functioning	
flashing	off	off	The controller is only occasionally accessing the bus. The outputs drop out.	Revise the controller software
lit	off	off	The ring is functioning, but the bus coupler is not addressed.	Revise the controller software or allocation list
lit	off	lit	I/O RUN is not lit, the bus terminal is addressed, but the data exchange via the K-bus has not been started.	Add the trigger call to the controller software

Beckhoff-Lightbus coupler BK2000

Presentation of the Beckhoff-Lightbus system

The Beckhoff-Lightbus is widely accepted in automation technology thanks to its speed and its cross-manufacturer use. The Beckhoff-Lightbus came into being within the scope of a comptroller concept for the realization of NC axes on the industrial PC. The aim of the project was to develop an industrially suitable, high-speed and reliable I/O level for the PC. A large number of diverse products from independent manufacturers is nowadays available. The operation of diverse Beckhoff-Lightbus units on one bus system is ensured by implementation support and protocol ASICs from the BECKHOFF company.

The Beckhoff-Lightbus was conceived for a fast exchange of data at the sensor/actuator level. Here, central controllers (for example, programmable logic controllers) communicate via a high-speed serial link with decentralized input and output devices. Data is exchanged with these decentralized devices cyclically and, if required, with different priorities. The central controller (the master) reads the input information from the slaves and sends the output information to them. In doing so, the bus cycle time must be shorter than the program cycle time of the central controller which, in many applications, is less than 1 ms.

A high data throughput alone does not suffice for the successful use of a bus system. Instead, easy handling, good diagnostics possibilities and fault-free transmission technology must be provided to meet users' requirements. With the Beckhoff-Lightbus, these characteristics are optimally combined.

At a data transfer rate of 2.5 Mbits/s, Beckhoff-Lightbus needs approximately 0.8 ms to transfer 512 bits of input data and 512 bits of output data distributed to 32 stations. Therefore, the call for a short system reaction time is ideally met.

System configurations and device types

A mono master system can be realized with the Beckhoff-Lightbus. A maximum of 254 slaves can be connected to one bus. In the BK2000 bus coupler, a station address between 1 and 254 is selected automatically in the startup phase. The system configuration definitions contain the number of stations, the allocation of the station address to the I/O addresses, data consistency of the I/O data and the format of diagnostic messages. Every Beckhoff-Lightbus system consists of different device types.

An Beckhoff-Lightbus slave is a peripheral device (sensor/actuator) that reads in input information and which sends output information to the periphery. Devices are also possible that only provide input information or only output information. Typical Beckhoff-Lightbus slaves are devices that feature binary inputs/outputs for 24V or 230V, analog inputs, analog outputs, counters and incremental encoders etc. The quantity of input and output information depends on the device and is defined by protocol ASIC as 32 bits of input data and 32 bits of output data. For slaves that handle a larger amount of data than 32 bits, for example the BK2000, use is made of an extended method. By means of an addressed access method, it is possible to read and write up to 256 x 16 bits. This means that one system is capable of processing up to 254 stations x 508 bytes (not all 512 bytes are used as user information data) in only one Beckhoff-Lightbus system. To reduce complexity and for implementation reasons, the currently available masters operate with a maximum user information data length of 3 Kbytes (24,000 inputs and outputs).

The master interfaces can be subdivided into two fundamental groups, the PC boards C1200 and C1220 and the PLC boards C1120, C1300, C1400, C1500 and C1600. The PC boards are configured by PC using the SPS TwinCAT or S2000 software or using corresponding high-level language drivers. The PLC boards feature an RS232 interface through which the configurations can be set using a PC. The configuration package for the PLC boards is referred to as the S1120.

The telegram structure and addressing

Data is exchanged between the master and slaves by way of individual telegrams. The telegrams address the station and simultaneously transport 4 bytes of output data to the slave and 4 bytes of input data from the slave to the master. One telegram has a run time of 25 µs.

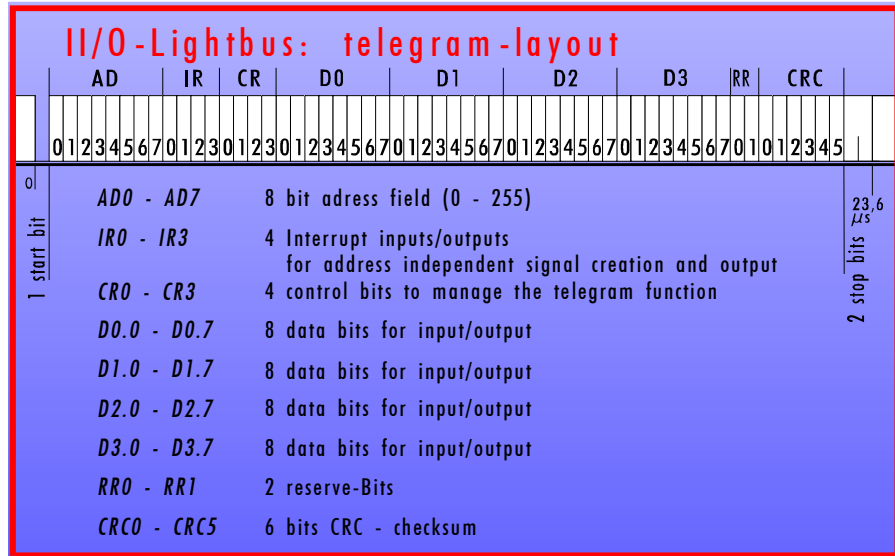

The controller can access a station between 1 and 255 (via the master) by way of the address field AD. The address of a station is distributed by the master during the startup phase in the physical order of the stations on the ring. The station after the master is assigned the address 1, and all further stations are assigned a consecutive number. Each station receives a telegram with the structure described above. The data length is defined as 4 bytes. The master sends a telegram with an address and corresponding data to a station. The station accepts the data and sends its own data to the master in the same telegram.

Access to a bus coupler

The bus coupler is an intelligent slave. Thanks to its processor, it is capable of offering extensive functions. Use of a bus coupler's functions requires an extensive exchange of data. A bus coupler is addressed with the telegrams in the way described above. However, the bus coupler is capable of processing a far greater number of bytes than only four bytes. The bus coupler creates an internal process image which, subdivided into input and output areas, is organized in words in the memory. The first data byte D0 of the telegram for selection of a memory word is used to address a word from the memory. The second data byte D1 operates as a control byte with which it is possible to switch between the "READ" and "READ/WRITE" modes. With the contents "00", the telegram has a "READ capability", i.e. input data is written into the bus coupler's memory and the contents of the input memory with the corresponding address are copied into the telegrams. The contents 128 (80hex) in the byte D1 initiate a "READ/WRITE access". The contents of the telegram are copied into the output memory and the input memory is additionally read and transferred to the master.

For access to the bus coupler's memory area, a constant must be additionally assigned to the control byte of the telegram. The contents 10hex signify that a "Page 0 WRITE access" to the memory is enabled.

The contents "00" only enable "Page 0 READ accesses". In later master versions, control bytes other than only "10hex" and "00hex" are also possible. Access to Page 1 is enabled with the control byte "30hex". Page 0 contains process data, whereas Page 1 contains internal registers and parameters of the bus coupler.

The data bytes D2 and D3 of the telegram serve to transport data out of the memory and into the memory of the bus coupler. Access is always word-oriented, and byte access is not possible. The connection between the memory address and the periphery is described in the chapter entitled "The periphery data in the process image".

To ensure data consistency, the bus coupler must be synchronized for master access. The bus coupler is triggered to update the periphery by means of three different mechanisms. The first possibility is to send the following telegram:

Control	D0	D1	D2	D3
10hex	FFhex	80hex	xx	Toggle, Info - Byte

An "update command" is triggered by modification of the data byte D3 (toggle byte, TGL), i.e. it is written with a changing pattern. The bus coupler queries this address constantly and begins to update the inputs and outputs after a change in the pattern. Once the update has been successful, the bus coupler copies the toggle pattern out of the output memory address 255 into the input memory. The master can query the bus coupler's status by querying this memory address. The second byte at address 255 is a status and info byte that contains information about the bus coupler.

A further possibility of getting the bus coupler to run an update is to trigger an interrupt, the "Int command". A memory cell with the address 255

Control	D0	D1	D2	D3
30hex	FFhex	80hex	xx	xx

is written and immediately triggers an interrupt in the bus coupler. The contents of the memory cell are deleted by access of the bus coupler to this cell. The contents can practically not be read back for as long as the bus coupler is running in the interrupt routine.

The third possibility of sending the "update command" is particularly interesting with regard to large systems. Here, a "BROADCAST telegram" can be sent. This telegram causes all bus couplers in the ring to run an update.

Control	D0	D1	D2	D3
0Bhex	FFhex	80hex	xx	xx

In the TwinCAT and S2000 software, access to the BK2000 bus coupler is run automatically. Its operating principle is transparent to the user.

Diagnostic and status functions

The extensive diagnostic functions of the Beckhoff-Lightbus enable swift location of errors. The master is capable of determining the position of an error. For error messages of the bus coupler or the bus terminals, the bus coupler has registers in which the messages can be retrieved. The diagnostic messages are accommodated in Page 1 of the bus coupler (telegram with the control byte "30hex").

The following messages can be retrieved from Page 0 and Page 1 at the address 255.

The BK2xxx bus couplers support the status messages via the Beckhoff-Lightbus

Bit	Description
D2.0	Command error
D2.1	Input data error
D2.2	Output data error
D2.3	Timeout error
D2.4	K-bus reset error
D2.5	
D2.6	
D2.7	Inputs valid
D3.0	Toggle pattern for operation without interrupt (Page 0 only)
D3.1	Toggle pattern for operation without interrupt (Page 0 only)
D3.2	Toggle pattern for operation without interrupt (Page 0 only)
D3.3	Toggle pattern for operation without interrupt (Page 0 only)
D3.4	Toggle pattern for operation without interrupt (Page 0 only)
D3.5	Toggle pattern for operation without interrupt (Page 0 only)
D3.6	Toggle pattern for operation without interrupt (Page 0 only)
D3.7	Toggle pattern for operation without interrupt (Page 0 only)

Special functions

The following special functions are entered in Page 0 (control byte 10hex) at the address 254 (D0 = "FEhex").

The BKxxx bus couplers support the special Functions via the Beckhoff-Lightbus

Bit	Description
D2.0	
D2.1	
D2.2	
D2.3	Allocation to the S5 PLC (only with master C1120)
D2.4	Allocation to the fast communication channel
D2.5	
D2.6	
D2.7	Immediate auto reset if K-bus error
D3.0	Connect digital input 0.0 to Beckhoff-Lightbus IRQ0
D3.1	Connect digital input 0.1 to Beckhoff-Lightbus IRQ1
D3.2	Connect digital input 0.2 to Beckhoff-Lightbus IRQ2
D3.3	Connect digital input 0.3 to Beckhoff-Lightbus IRQ3
D3.4	FreeRun Write (without watchdog)
D3.5	FreeRun Write (with watchdog)
D3.6	FreeRun Read
D3.7	Auto reset after diagnostics flashing sequence

Update and Int command synchronisation

In addition to user information data traffic, which is handled automatically by the master, it is possible to send control commands to one or to all slaves simultaneously. These control commands are transferred as single trigger or as broadcast functions. With these control commands, it is possible to specify updating of the input/output level to synchronize all BK2000s. The BK2000s begin updating when they receive an "update" or an "Int control command" from the assigned master. With the broadcast function, the outputs of all addressed BK2000s are frozen at their momentary status. During subsequent user information data transfers, the output data of the BK2000s is stored, but the output statuses remain unchanged. The stored output data is switched through to the outputs when the next update or Int control command is received from the master. The user can read back the update control command after successful execution.

The Int command can also be triggered by a broadcast telegram. The master can therefore trigger a simultaneous interrupt in all stations. The control byte in the telegram is written with 0Bhex to use a broadcast. The telegram address during the broadcast telegram is "255".

System behavior

The system behavior of the Beckhoff-Lightbus was standardized to ensure interchangeability of hardware. It is essentially defined by the operating states of the Beckhoff-Lightbus modules belonging to previous series. The following two main states are distinguished:

Modes	
Stop	No data communication takes place between the master and the slaves. The bus coupler only addresses the bus terminals once after power-on. It then does not address them again (none of the I/O LEDs is lit).
Operation	The master is in the data transfer phase. Within the scope of cyclic data communication, the inputs of the slaves are read and the output information is transferred to the slaves (the green I/O LED is lit).

The master cyclically sends telegrams to all slaves in the ring at an interval that depends on the size of the system and the parametrization. A slave demands a valid telegram every 23 ms. This telegram need not necessarily be addressed to a slave. The slave assumes an error state if it does not receive it regularly. The green CYC LED no longer lights up and the red ERROR LED additionally indicates an errored telegram. The system reaction after the occurrence of an error in the master's data transfer phase, e.g. failure of a slave, is defined by the fixed "watchdog timer" operating parameter. If its time period has been exceeded, the slave switches the outputs to the safe state. As soon as a slave is no longer ready for user information data transfers, or transfer from the master has been interrupted or is disturbed, after a slave has switched to the STOP state the other slaves also directly assume this STOP state.

Data communication between the slaves

Data communication between the master and the slaves is handled automatically by the master in a defined, recurring order. When considering the bus system, the user defines the affiliation of a slave to diverse priority levels, "CDLs", in the master. In doing so, it is possible to use one slave simultaneously in several "CDLs". In one bus coupler, different sub-areas of the data can also be queried in different "CDLs".

Data communication between the master and the slaves is broken down into parametrization, configuration and data transfer phases. Before a slave is included in the data transfer phase, the master checks in the parametrization and configuration phase whether the configured nominal configuration agrees with the actual hardware configuration and the arrangement in the ring. During this check, the device type, the format and length information and the number of inputs and outputs must agree. This provides the user with protection against parametrization errors. In addition to user information data transfer, which is realized automatically by the master, it is possible to send new parametrization data to the Beckhoff-Lightbus coupler at the user's request.

The medium: connectors and cables

The Beckhoff-Lightbus exclusively uses fiber-optic cable to transfer its data. Two different cable types, plastic and fiber optic cables, are available in a standard sheath and a protective sheath version.

Fundamental characteristics of fiber-optic transmission technology

The medium	
Network topology	Ring system, active stations between the wiring sections
Medium	Z1100 plastic fiber-optic conductor Z1101 plastic fiber-optic conductor with PU sheath Z1110 HCS fiber-optic conductor Z1111 HCS fiber-optic conductor
Number of stations	254 stations in the ring
Max. bus length	
with plastic fiber-optic conductor	0.3 m to 45 m
Min. bending radius	3 cm
with HCS fiber-optic conductor	up to 300 m
Min. bending radius	4 cm
Data transfer rate	2.5 MBit/s
Connectors	Z1000 standard connector for plastic fiber-optic conductors Z1010 standard connector for HCS fiber-optic conductors

It is possible to prepare plastic fiber-optic conductors using usual tools. Special tools are needed to prepare the HCS conductors. You can obtain the wiring from us, even ready for assembly, by specifying the length. For detailed information, please refer to the overview entitled "Fiber-optic conductors, connectors and accessories" in the "Beckhoff-Lightbus" catalog or the fiber-optic conductor installation instructions.

A closed ring must be established in one system. The data path begins in the master and passes through all stations. The return path must end in the master again.

The plastic fiber-optic cable can be processed without special tools. A connector can be produced swiftly and reliably using a knife, pliers and emery paper. The connector engages in the slaves.

Each station in the ring has on "incoming" and a "continuing" Interface. Swapping of the "incoming" and "continuing" interfaces will not damage them. In the activated state, the fault can be located easily. The red lit end of the fiber-optic conductor is plugged into the interface that is not lit.

Configuration of masters

As already explained, the Beckhoff-Lightbus coupler creates a data area with input and output bytes. The bus coupler establishes the affiliations between channels of the bus terminals and the bits and bytes of the process image.

The Beckhoff-Lightbus master exchanges a coherent input and output data block with every Beckhoff-Lightbus coupler, as defined by a CDL. In the case of the C1200 and the C1220, the affiliations of the bytes from this data block to the addresses of the process image are established by the TwinCAT PLC software or S2000 and, in the case of the PLC interfaces, this is done by the Sxxxx software (xxxx stands for the designation of the corresponding Cxxxx board). For other masters, use must be made of corresponding manufacturer tools (please inquire).

Configuration software for master configuration

Interface type	Interface designation	Configuration software
PC interface	C1200 C1220	S1100 S1120 and contained in TwinCAT, S2000, S2100 and S2200
PC with Beckhoff-Lightbus	Beckhoff IPC products with C1230	contained in TwinCAT, S2100 and S2200
PLC interface	C1xxx	C1xxx
General		General

Ensuring data consistency

Consistency of a station's data is ensured by the data transfer protocol of the Beckhoff-Lightbus. Consistency throughout the entire process image can be achieved by activation of the "Update" and "Int" commands in the master.

Asynchronous access by the controller CPU (in most cases PLC or IPC) to the data area of the Beckhoff-Lightbus master may lead to inconsistency. The Beckhoff-Lightbus masters contain mechanisms for avoiding asynchronous access, thus ensuring data consistency. For further explanations, please refer to the manuals of the corresponding interfaces.

Annex

Example: combination of a process image in the bus coupler

An example explains how the input and output channels are allocated to the process image. The example setup will consist of the following bus terminal modules:

The bus coupler creates the following allocation list with this configuration

Position	Function module on the rail
POS01	Bus coupler
POS02	Digital inputs, 2 channels
POS03	Digital inputs, 2 channels
POS04	Digital inputs, 2 channels
POS05	Digital inputs, 2 channels
POS06	Digital inputs, 2 channels
POS07	Digital outputs, 2 channels
POS08	Digital outputs, 2 channels
POS09	Digital outputs, 2 channels
POS10	Analog inputs, 2 channels
POS11	Analog outputs, 2 channels
POS12	Analog outputs, 2 channels
POS13	Analog inputs, 2 channels
POS14	Infeed terminal
POS15	Digital inputs, 2 channels
POS16	Digital inputs, 2 channels
POS17	Digital inputs, 2 channels
POS18	Digital outputs, 2 channels
POS19	Digital outputs, 2 channels
POS20	Analog outputs, 2 channels
POS21	End terminal

Part for byte-oriented data, analog outputs

Relative byte address	Bit position	Process image in the controller	Position in the block
0, 1, 3, 4	none	A0, A1, A2	POS11
5, 6, 7, 8	none	A3, A4, A5	POS11
9, 10, 11, 12	none	A6, A7, A8	POS12
13, 14, 15, 16	none	A9, A10, A11	POS12
17, 18, 19, 20	none	A12, A13, A14	POS20
21, 22, 23, 24	none	A15, A16, A17	POS20

Part for non-byte-oriented data, digital outputs

Relative byte address	Bit position	Process image in the controller	Position in the block
25	0	A18	POS07
25	1	A18	POS07
25	2	A18	POS08
25	3	A18	POS08
25	4	A18	POS09
25	5	A18	POS09
25	6	A18	POS18
25	7	A18	POS18
26	0	A19	POS19
26	1	A19	POS19

Part for byte-oriented data, analog inputs

Relative byte address	Bit position	Process image in the controller	Position in the block
0, 1, 3, 4	none	E0, E1, E2	POS10
5, 6, 7, 8	none	E3, E4, E5	POS13

Part for non-byte-oriented data, digital inputs

Relative byte address	Bit position	Process image in the controller	Position in the block
9	0	E6	POS01
9	1	E6	POS01
9	2	E6	POS02
9	3	E6	POS02
9	4	E6	POS03
9	5	E6	POS03
9	6	E6	POS04
9	7	E6	POS04
10	0	E7	POS05
10	1	E7	POS05
10	2	E7	POS06
10	3	E7	POS06
10	4	E7	POS15
10	5	E7	POS15
10	6	E7	POS16
10	7	E7	POS16
11	0	E8	POS17
11	1	E8	POS17

The positions POS14 and POS21 are not relevant in relation to the exchange of data. They do not appear in the list. If a byte, e.g. E11, is not used completely, the bus coupler pads the remaining bits of the byte with zeros.

Overview of the breakdown of the process image in the bus coupler:

Output data in the bus coupler

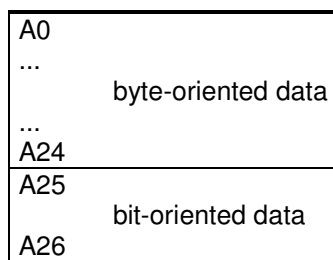

Input data in the bus coupler

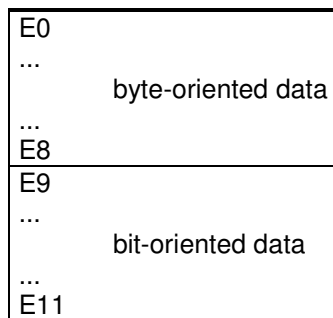

The base addresses E0 and A0 listed here are relative addresses or addresses in the bus coupler. Depending on the higher-level field bus, the addresses may be placed in a freely chosen position in the controller's process image by the bus master. The master's configuration software

enables allocation of the bytes to the addresses of the controller's process image. The control/status bytes of the analog channels can also be included if required.

Examples S2100 Setup Digital Terminals

Example 1

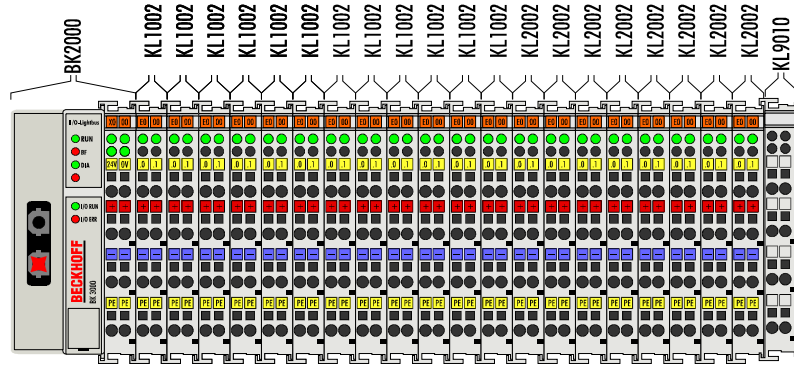

1 coupler + 12 terminals 2 channel Digital In + 4 terminals 2channel Digital Out

```

□ 21.03.96 10:57:14
II/O 1/ 0 Boxen

```

Lfd	Box	Kom	Bezeichnung	Block	D0	D1	D2	D3	Fnkt
1	1	1	Dig IN	0	M 0	K 0	E 10	E 11	0
2	1	2	Dig IN	0	M 1	K 0	E 12	0	0
3	1	3	Dig Out	0	M 0	K 128	A 10	A 11	0
4	1	4	Interrupttelegramm	0	M 255	KS 128	0	0	0
5	0	0		0	0	0	0	0	0
6	0	0		0	0	0	0	0	0
7	0	0		0	0	0	0	0	0
8	0	0		0	0	0	0	0	0
9	0	0		0	0	0	0	0	0
10	0	0		0	0	0	0	0	0

Für weitere Informationen bitte die Tasten
Ctrl <←>
betätigen

IIO-Puffer: D0000000 IIO-Adresse: D0000000

(C) BECKHOFF IndustrieElektronik Eiserstr.5 33415 Verl 1 Tel.: 05246/709-0

F1 F2 F3 F4 F5 F6 F7 F8 F9 F10

Example 2

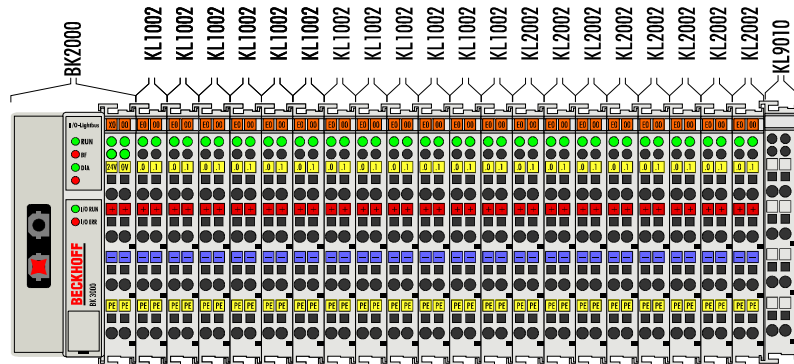

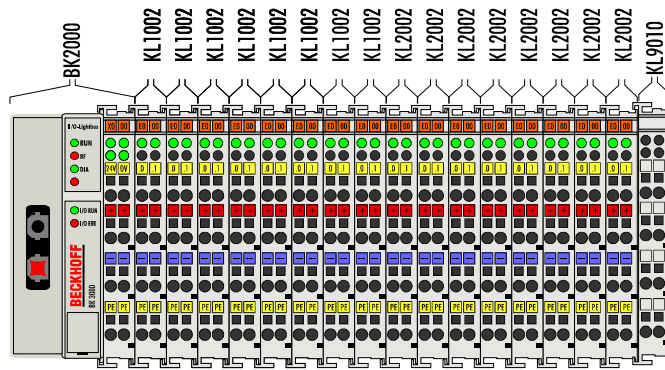

```

Erweiterung um einen Koppler. □ Sps-Warntmeldung 20300.1
I/O 1/ 0 Boxer
Lfd Box Kom Bezeichnung Block D0 D1 D2 D3 Fnkt
1 1 1 Dig IN 0 M 0 K 0 E 10 E 11 0
2 1 2 Dig IN 0 M 1 K 0 E 12 0 0
3 1 3 Dig Out 0 M 0 K 128 A 10 A 11 0
4 2 4 Dig IN 0 M 0 K 0 E 16 E 17 0
5 2 5 Dig Out 0 M 0 K 128 A 14 A 15 0
6 2 6 Interruptteleg. BRD 0 M 255 KB 128 0 0
7 2 7 0 0 0 0 0 0
8 0 0 0 0 0 0 0 0
9 0 0 0 0 0 0 0 0
10 0 0 0 0 0 0 0 0
Für weitere Informationen bitte die Tasten
Ctrl ←
betätigen
—IIO-Puffer:—D0000000 —IIO-Adresse:—D0000000
(C) BECKHOFF IndustrieElektronik Eiserstr.5 33415 Verl 1 Tel.: 05246/709-0
F1 F2 F3 F4 F5 F6 F7 F8 F9 F10
    
```

□ 21.03.96 10:58:30

Representation of the analog signals in the process image

Three input bytes and three output bytes of the process image are needed for each analog channel. Two bytes represent the value as signed integer (two's complement), i.e. 15 bits with sign. The data format is used regardless of the actual resolution. As an example: with a resolution of 12 bits, the four least significant bits are irrelevant. The least significant byte has control and status functions. Various operating modes can be set with the control byte. The six least significant bits can be used as addressing bits. Addressing serves to read and write a register set with string communication. The register set has 64 registers.

I/O bytes of an analog channel in the process image

Output byte 1	Output byte 0	Control byte	not used
---------------	---------------	--------------	----------

Input byte 1	Input byte 0	Status byte	not used
--------------	--------------	-------------	----------

Meaning of the control/status byte for access to the register model

Bit	
BIT 7	0 = NORMAL MODE, 1 = CONTROL MODE
BIT 6	0 = READ, 1 = WRITE
BIT 5	Register address, MSB
BIT 4	Register address
BIT 3	Register address
BIT 2	Register address
BIT 1	Register address
BIT 0	Register address, LSB

Register set of an analog channel

63			
47			
31			
	15	User area	
	0		
16	OFF	SET	
	GA	IN	
			Manufacturer settings
		SoftwareVers.	Type
0	Length	Type	Auxiliary process image

The meanings of the registers and the status bytes are explained in the bus terminals' corresponding data sheets. The structure of the module is identical for all bus terminals featuring extensive signal processing.

Entry of analog inputs in the S2100

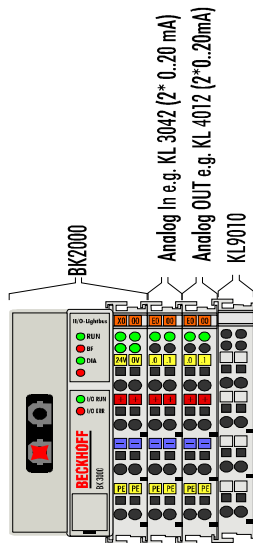

Control + Status + User information data

```

23.01.96 16:09:59
II/O 1/ 1 Boxen
Lfd Box Kom Bezeichnung Block D0 D1 D2 D3 Fnkt
1 1 1 Kanal 1 Control 0 M 0 K 128 A 10 0 0
2 1 2 Status 0 M 0 K 128 E 10 0 0
3 1 3 Nutzdaten 0 M 1 K 0 E 12 E 13 0
4 1 4 Kanal 2 Control 0 M 2 K 128 A 20 0 0
5 1 5 Status 0 M 2 K 0 E 20 0 0
6 1 6 Nutzdaten 0 M 3 K 0 E 22 E 23 0
7 1 7 0 M 255 KB 128 0 0 0
8 0 0 0 0 0 0 0 0 0
9 0 0 0 0 0 0 0 0 0
10 0 0 0 0 0 0 0 0 0

Für weitere Informationen bitte die Tasten
Ctrl <↵
betätigen

IIO-Puffer:—D0000000 IIO-Adresse:—D0000000
    
```

Nur Nutzdaten

```

23.01.96 16:09:59
II/O 1/ 1 Boxen
Lfd Box Kom Bezeichnung Block D0 D1 D2 D3 Fnkt
3 1 1 Kanal1 Nutzdaten 0 M 1 K 0 E 12 E 13 0
6 1 2 Kanal2 Nutzdaten 0 M 3 K 0 E 22 E 23 0
7 1 7 0 M 255 KB 128 0 0 0
8 0 0 0 0 0 0 0 0 0
9 0 0 0 0 0 0 0 0 0
10 0 0 0 0 0 0 0 0 0

Für weitere Informationen bitte die Tasten
Ctrl <↵
betätigen

IIO-Puffer:—D0000000 IIO-Adresse:—D0000000
    
```

Special case with older software versions or older driver software

Used with older software or with driver software that does not have any access to the control:

```

26.01.96 16:03:00
II/O 1/ 0 Boxen
Lfd Box Kom Bezeichnung Block D0 D1 D2 D3 Fnkt
1 1 1 Kanal 1 Control 0 A0 0 WR 0 A 10 0 0
2 1 2 Status 0 A0 0 RD 0 E 10 0 0
3 1 3 Nutzdaten 0 A1 0 RD 0 E 12 E 13 0
4 1 4 Kanal 2 Control 0 A2 0 WR 0 A 20 0 0
5 1 5 Status 0 A2 0 RD 0 E 20 0 0
6 1 6 Nutzdaten 0 A3 0 RD 0 E 22 E 23 0
7 1 7 0 A255 WR 0 ATOG ATOG 0 0
8 0 0 0 0 0 0 0 0 0
9 0 0 0 0 0 0 0 0 0
10 0 0 0 0 0 0 0 0 0

Für weitere Informationen bitte die Tasten
Ctrl <↵
betätigen

IIO-Puffer:—D0000000 IIO-Adresse:—D0000000
(C) BECKHOFF IndustrieElektronik Eiserstr.5 33415 Verl 1 Tel.: 05246/709-0
F1 F2 F3 F4 F5 F6 F7 F8 F9 F10
    
```

```

A0 0 Ausgangsbyte mit Inhalt 0 ADRESSE 0 IM KOPPLER
A1 0 Ausgangsbyte mit Inhalt 1 ADRESSE 1 IM KOPPLER
A2 0 Ausgangsbyte mit Inhalt 2 ADRESSE 2 IM KOPPLER
A3 0 Ausgangsbyte mit Inhalt 3 ADRESSE 2 IM KOPPLER
.
.
WR 0 Ausgangsbyte mit Inhalt 128 SCHREIBKENNUNG
RD 0 Ausgangsbyte mit Inhalt 0 LESEKENNUNG

A255 WR 0 ATOG ATOG Toggletelegramm.
ATOG: Ausgangsbyte mit wechselndem Inhalt 00/FFh
    
```

Support and Service

Beckhoff and their partners around the world offer comprehensive support and service, making available fast and competent assistance with all questions related to Beckhoff products and system solutions.

Beckhoff's branch offices and representatives

Please contact your Beckhoff branch office or representative for local support and service on Beckhoff products!

The addresses of Beckhoff's branch offices and representatives round the world can be found on her internet pages: <http://www.beckhoff.com>

You will also find further documentation for Beckhoff components there.

Beckhoff Headquarters

Beckhoff Automation GmbH

Eiserstr. 5

33415 Verl

Germany

phone: + 49 (0) 5246/963-0

fax: + 49 (0) 5246/963-198

e-mail: info@beckhoff.com

web: www.beckhoff.com

Beckhoff Support

Support offers you comprehensive technical assistance, helping you not only with the application of individual Beckhoff products, but also with other, wide-ranging services:

- support
- design, programming and commissioning of complex automation systems
- and extensive training program for Beckhoff system components

hotline: + 49 (0) 5246/963-157

fax: + 49 (0) 5246/963-9157

e-mail: support@beckhoff.com

Beckhoff Service

The Beckhoff Service Center supports you in all matters of after-sales service:

- on-site service
- repair service
- spare parts service
- hotline service

hotline: + 49 (0) 5246/963-460

fax: + 49 (0) 5246/963-479

e-mail: service@beckhoff.com