

采购找纬轩，价格您说了算！

品牌+型号+目标价格



我们的业务

非标机电设备生产

承接各种机械设备、机电设备、自动化流水线、烘烤设备、空气净化设备、工装设备设计与制造。

合作方式

提供技术要求或产品图纸，基本预算→ 提出设备方案或生产周期与成本→ 确定方案，签定合同协议→ 生产制造→调试安装→完结

进口工业贸易

专注全球知名品牌工业控制系统（DCS PLC），仪器仪表、传感器、编码器、高低压电气（断路器，接触器、开关等），无损检测仪（硬度、粗糙度、导电率、探伤仪等）、食品安全检测仪、环境检测仪、工业设备、机器人、气动液压自动化，CNC伺服控制等工业自动化装备与检测仪器进口贸易服务。

合作方式

提供品牌+型号+数量+目标价格→与供应商谈判→提供最佳价格与货期→确定合同→交货→完结

出口工业贸易

专注于非洲国家工业生产所需要的工业设备，机电设备，仪器仪表，高低压电气，金属材料，机器人，工装设备的供货贸易服务。

合作方式

提供品牌+型号+数量+目标价格→与供应商谈判→提供最佳价格与货期→确定合同→交货→完结

工业设备



流水线传送



风淋室



烟厂机器人



自动化烘烤设备

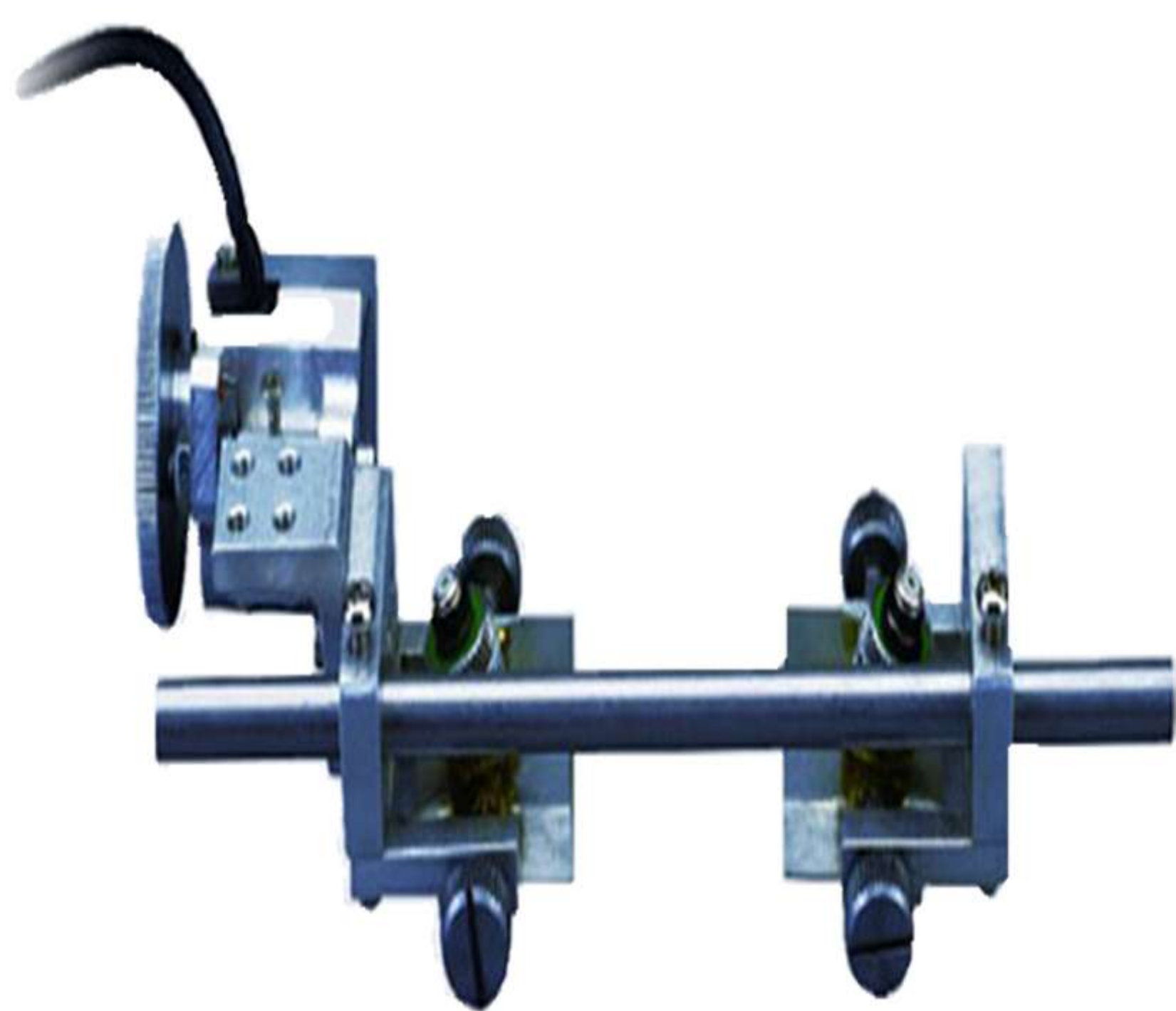

自动化检测装置



自动化组装机



电控柜

高低压电气

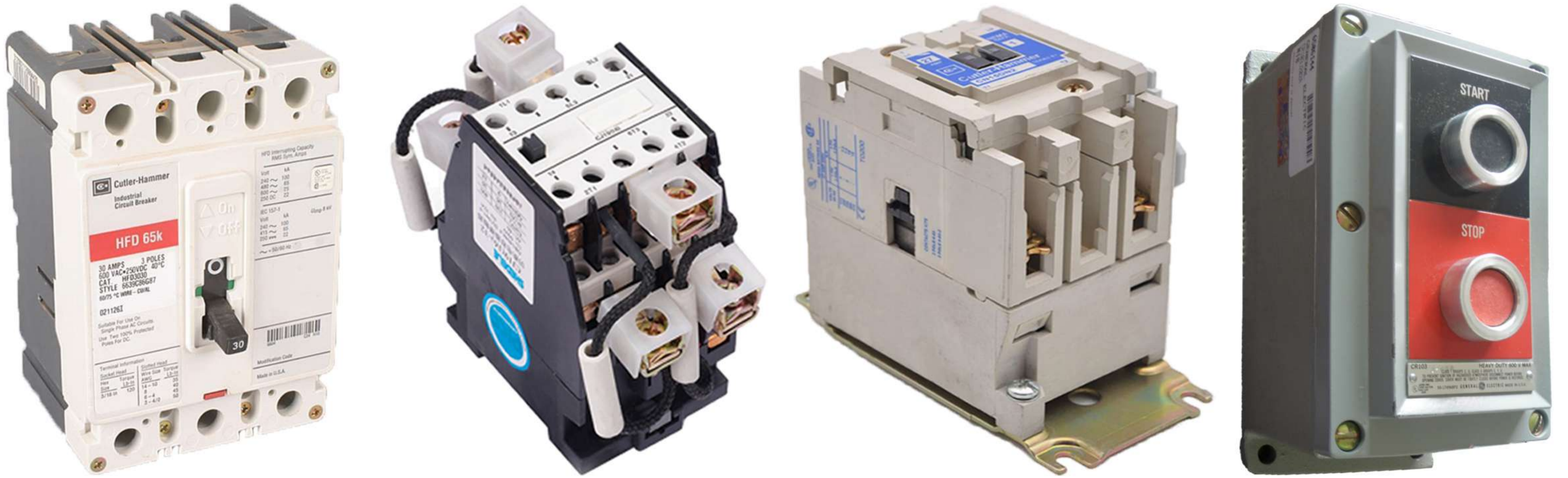

进口全球知名品牌的断路器、接触器、电容器、互感器、变压器等电气元件。

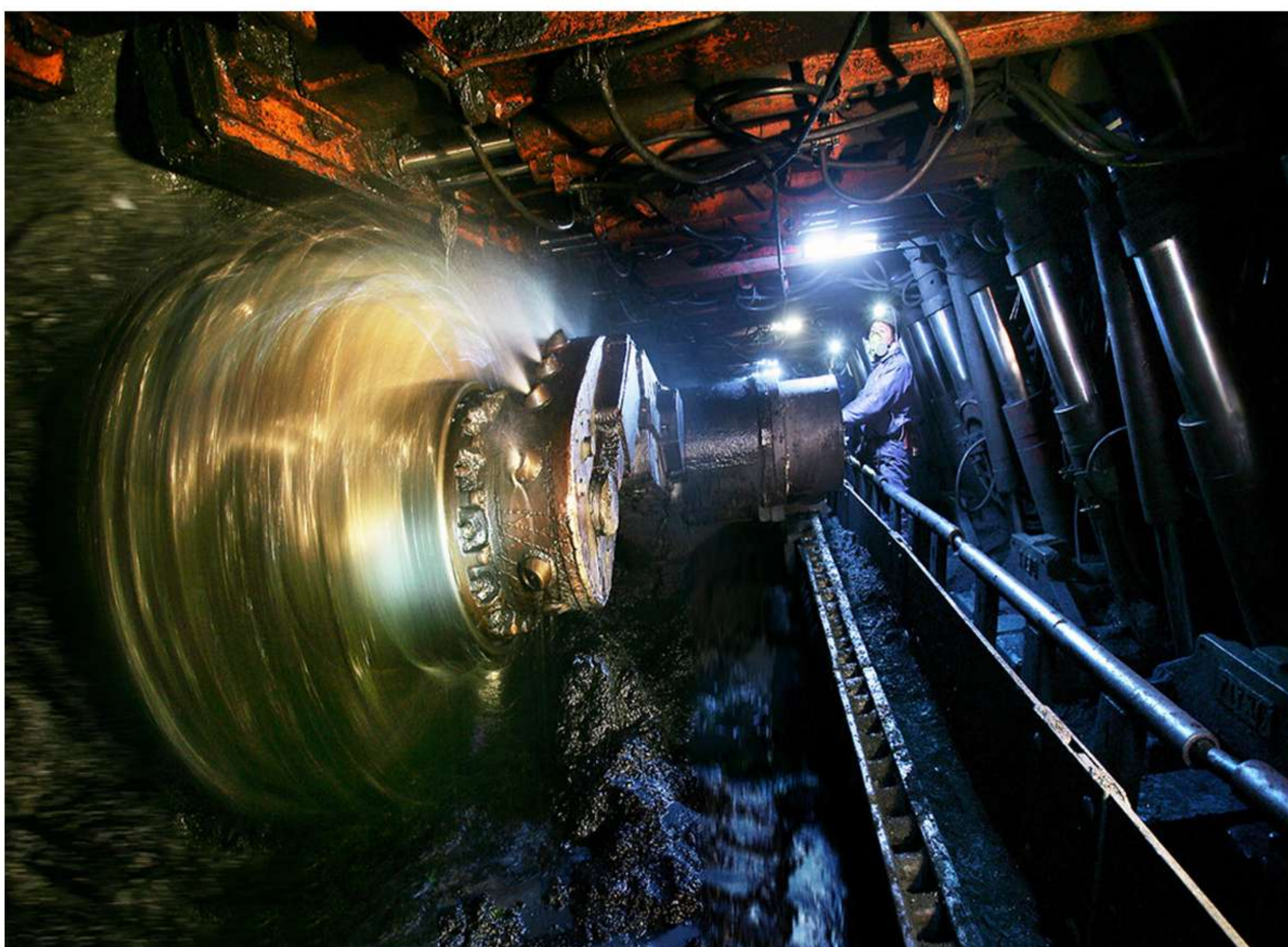
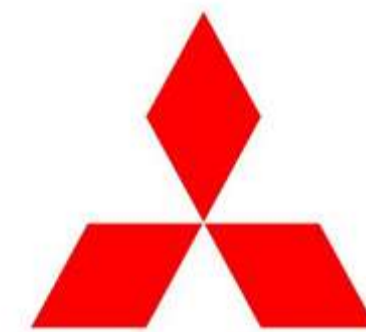

工业机器人



专业进口机器人销售与技术服务。

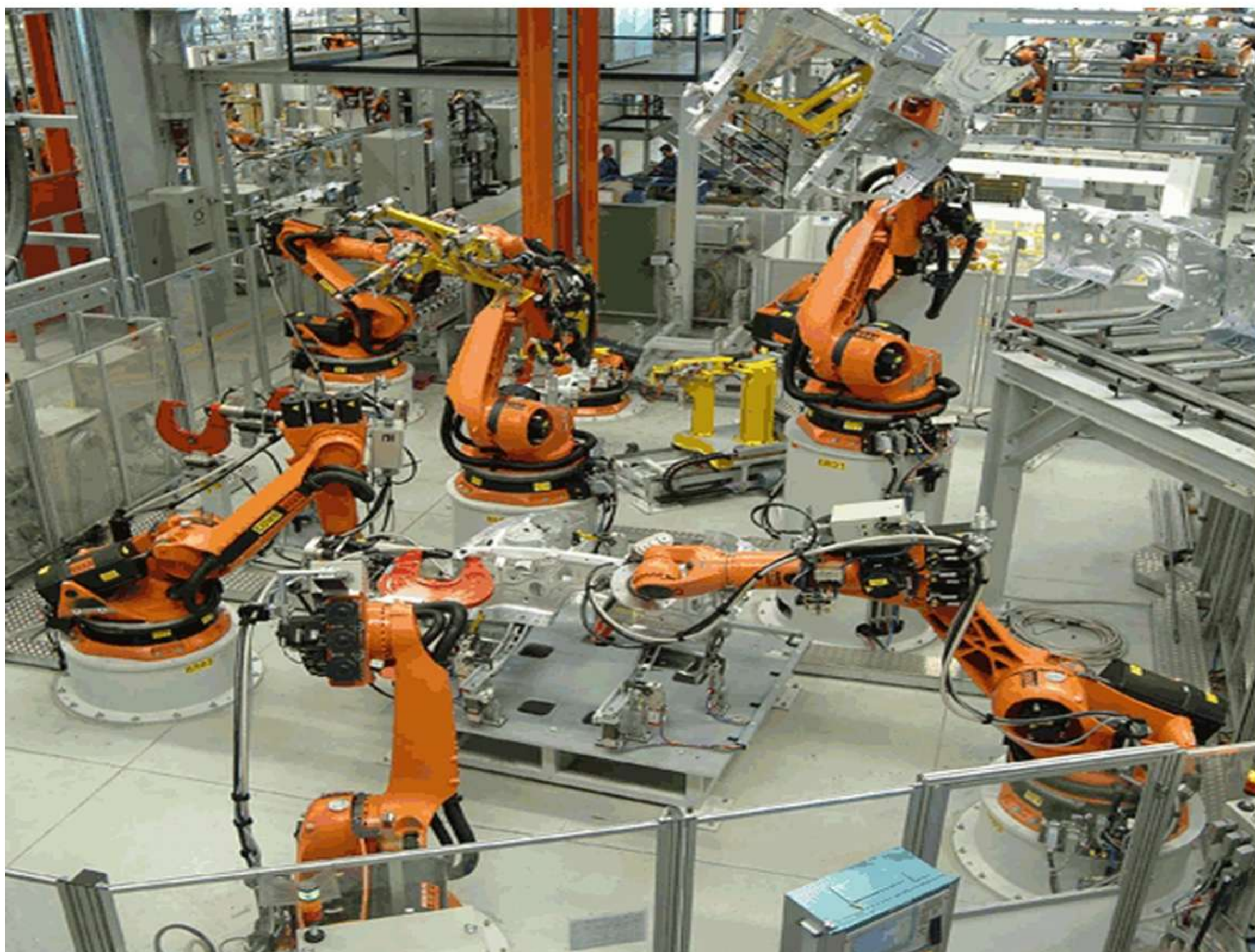
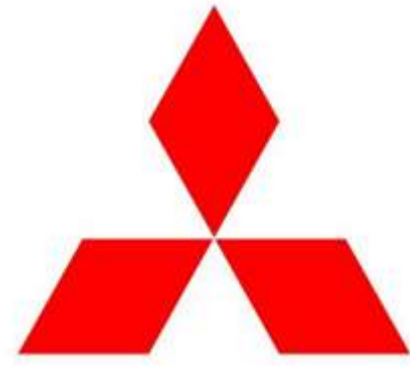

DCS PLC CNC



专注进口集散控制系统DCS、PLC、数控CNC系统集成备件贸易服务。



NDT无损检测仪



专注于进口无损检测仪器设备贸易服务。

OLYMPUS

DeFelsko

FLUKE

FOERSTER

FISHER



elcometer
inspection equipment

Krautkramer

proceq

PROTEC



COMET GROUP
Technology with Passion

TAYLOR HOBSON



ue
SYSTEMS INC

TRANSCAT



自动化

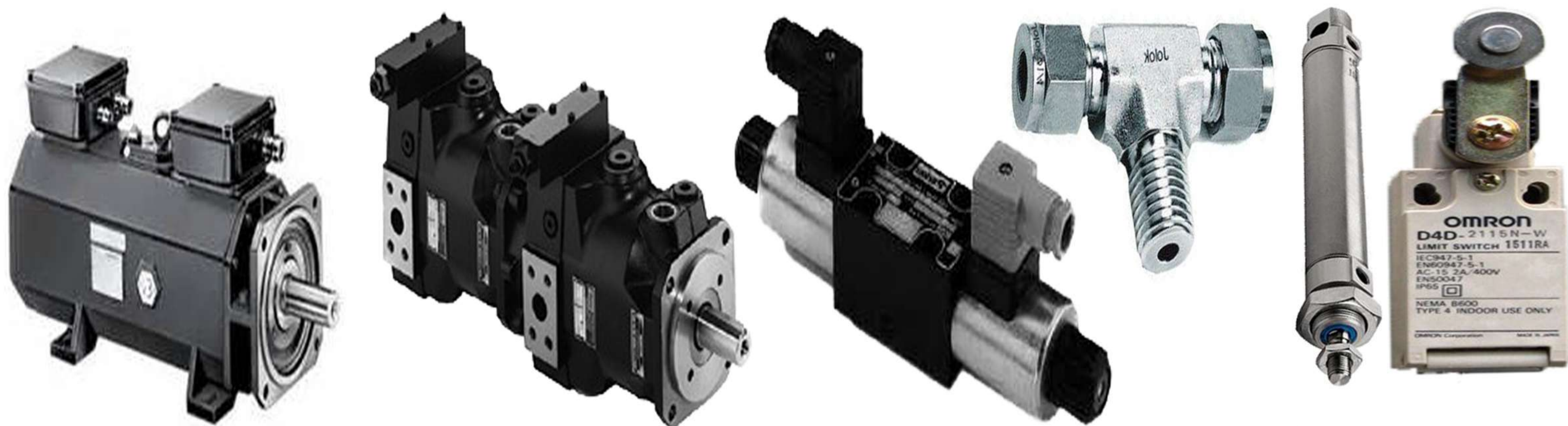

专注于进口电机、泵、阀、气缸、接头、行程开关等品牌备件贸易服务。

ASCO

COOPER

MOOG

Rexroth

Parker

VICKERS

SMC

BOSCH

**CONTINENTAL
HYDRAULICS**

Honeywell

GRUNDFOS

WILO

FORT VALE

KSB

pilz

Danfoss

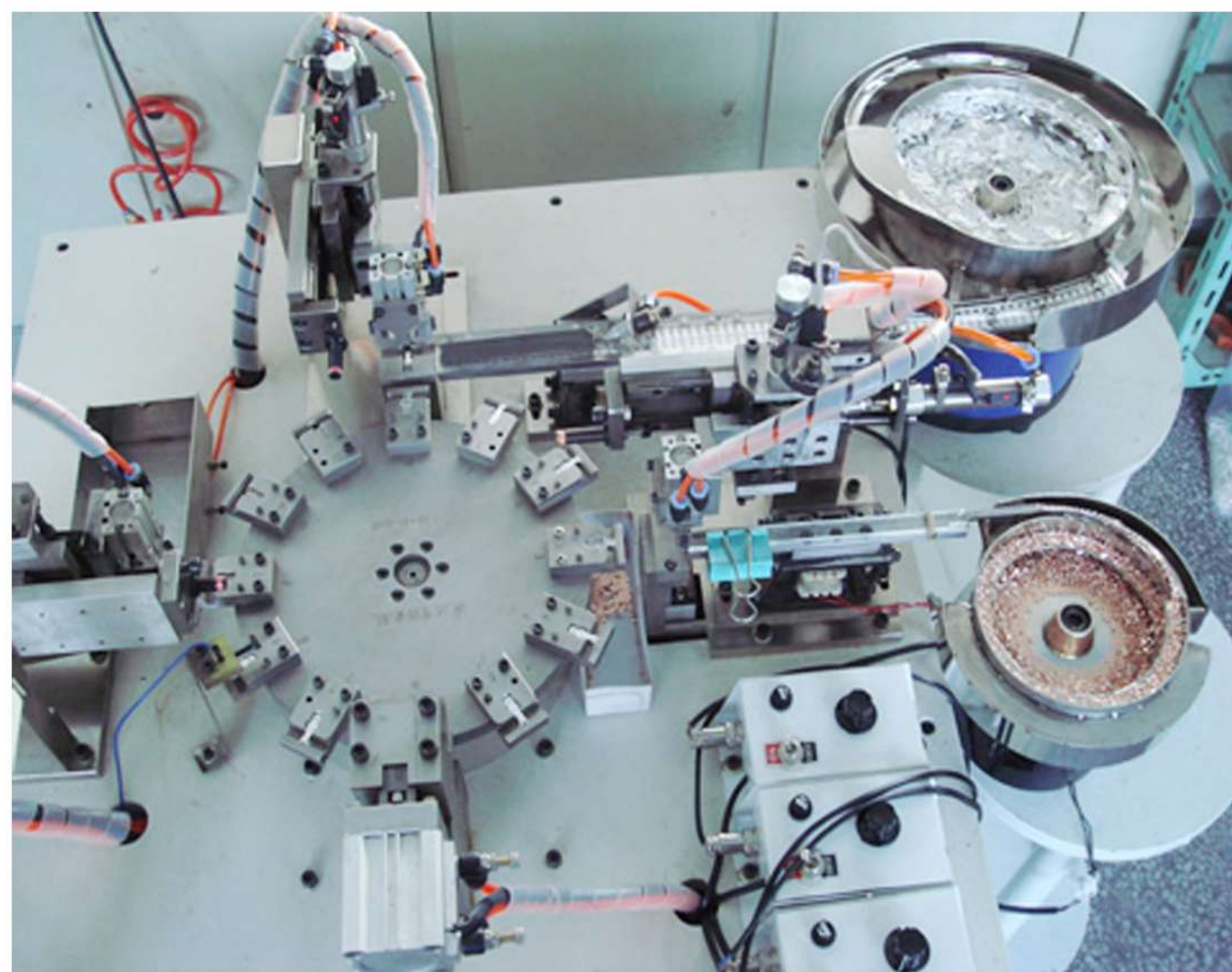
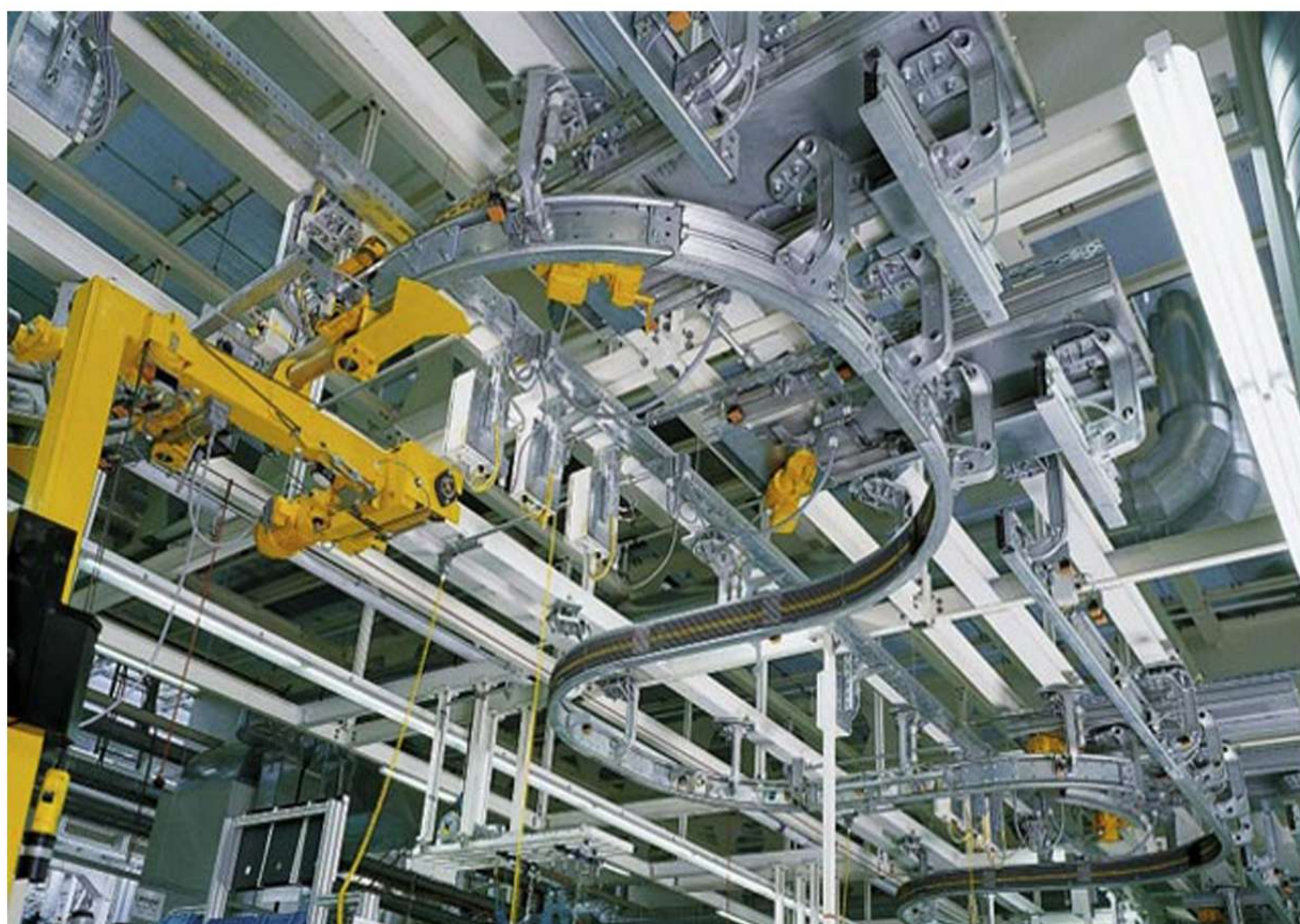

传感器、光电开关、编码器



进口传感器、光电开关、编码器等品牌备件贸易服务。

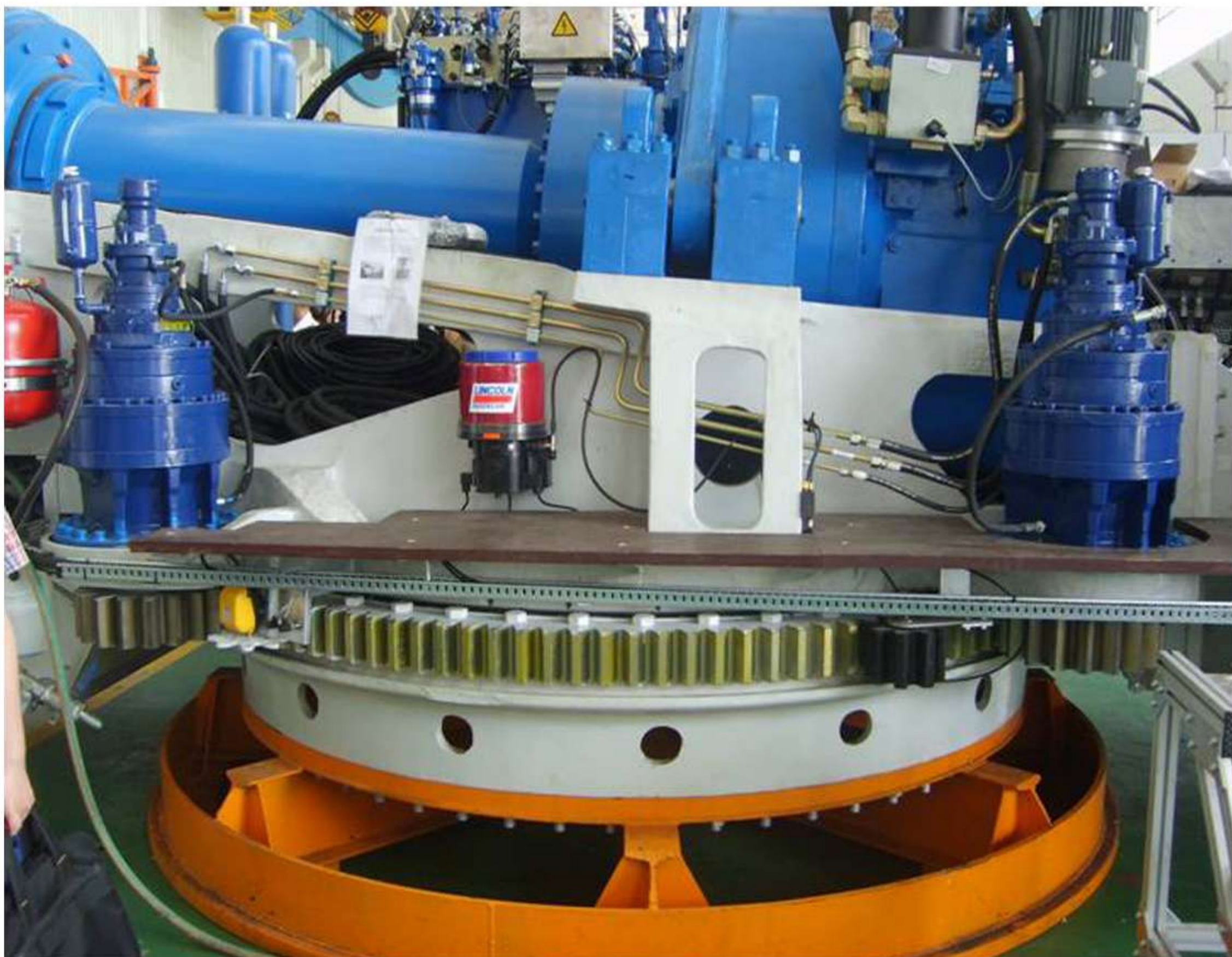
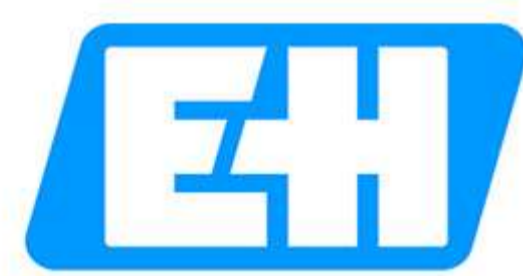

进口设备、量具

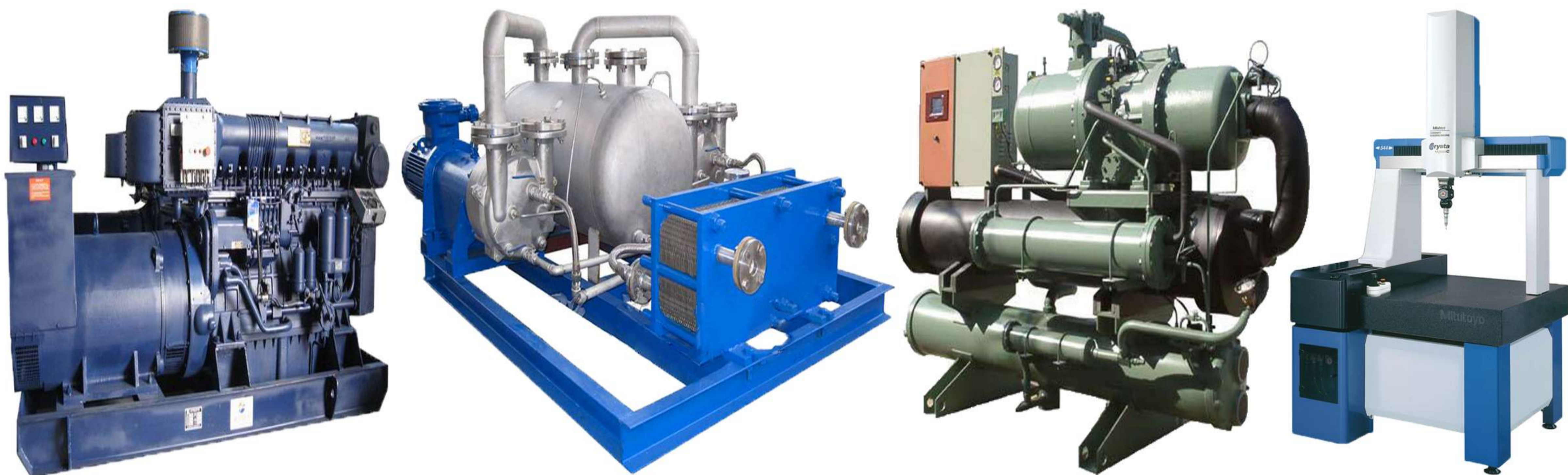

全球知名品牌工业设备、全球知名品牌量具。

SIEMENS

Schneider
Electric

TURCK

Mitutoyo

ABB

OMRON

EMERSON

Rexroth

EATON

GRUNDFOS



FANUC

cabur



**LENORD
+BAUER**

**MAGNETI
MARELLI**

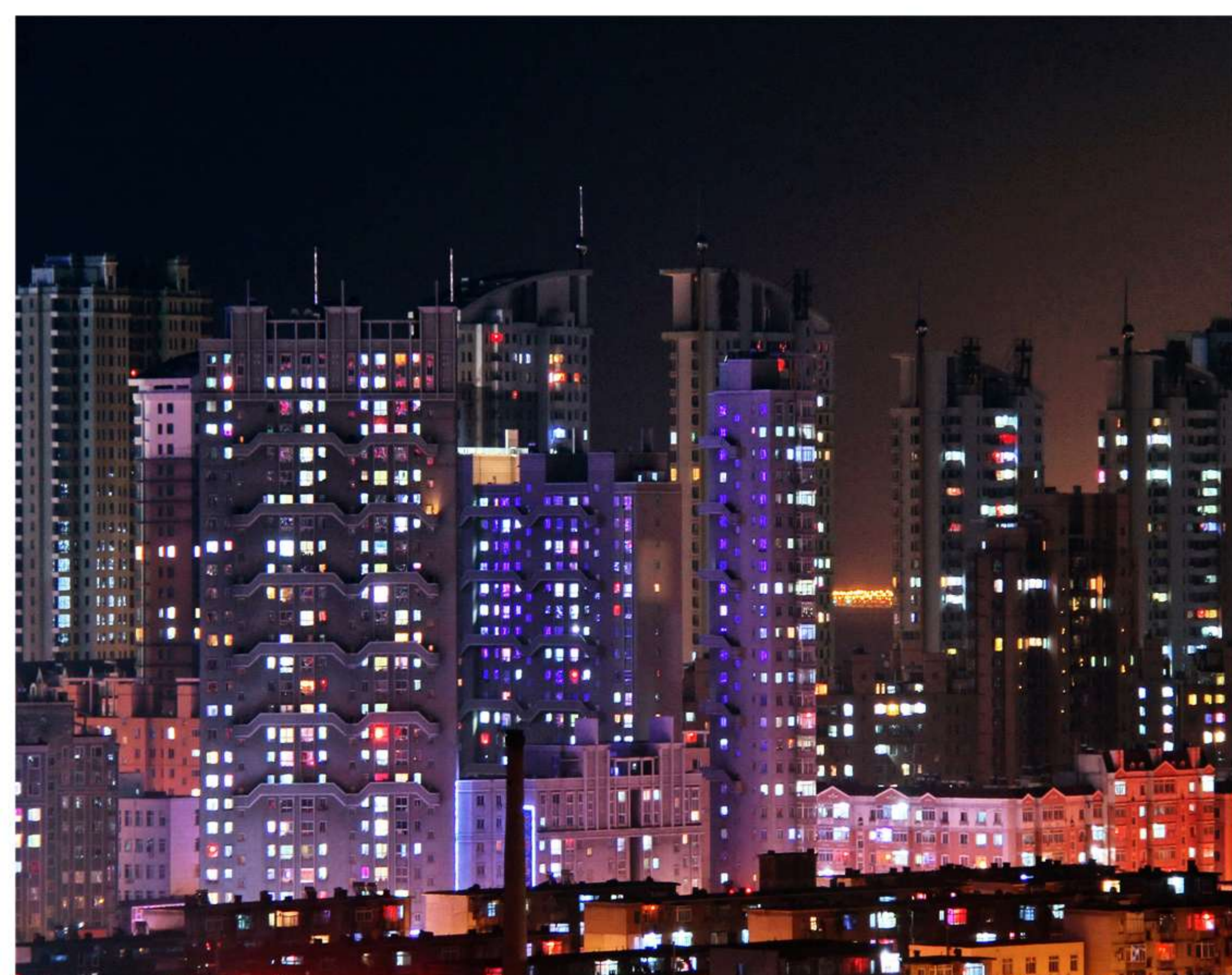

全球采购



AMERICA



美洲专职采购：午炎昌

我负责美洲地区产品询价与采购，毕业于仪器与自控专业。只要您告诉我要采购的东西，不管有多大的困难，我一定全力以赴，找到满足你需要的产品。



EUROPE

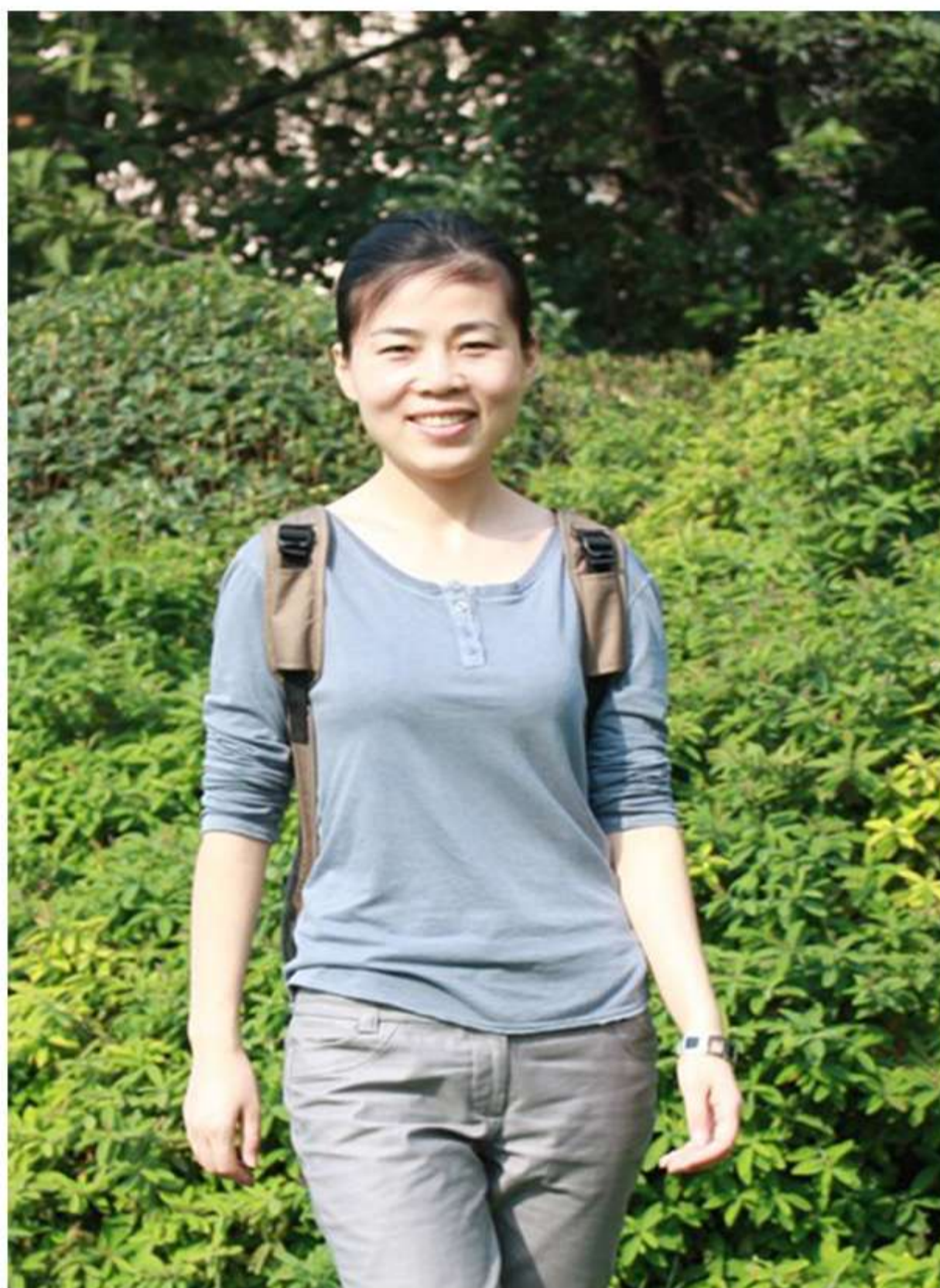

欧洲专职采购：李昱丽

我负责德国，意大利，瑞士等地区产品询价与采购，请您把你的采购需求告诉我，不论在欧洲的那个地区，我都会亲自到厂家去谈判，以达到您要求的产品与价格。

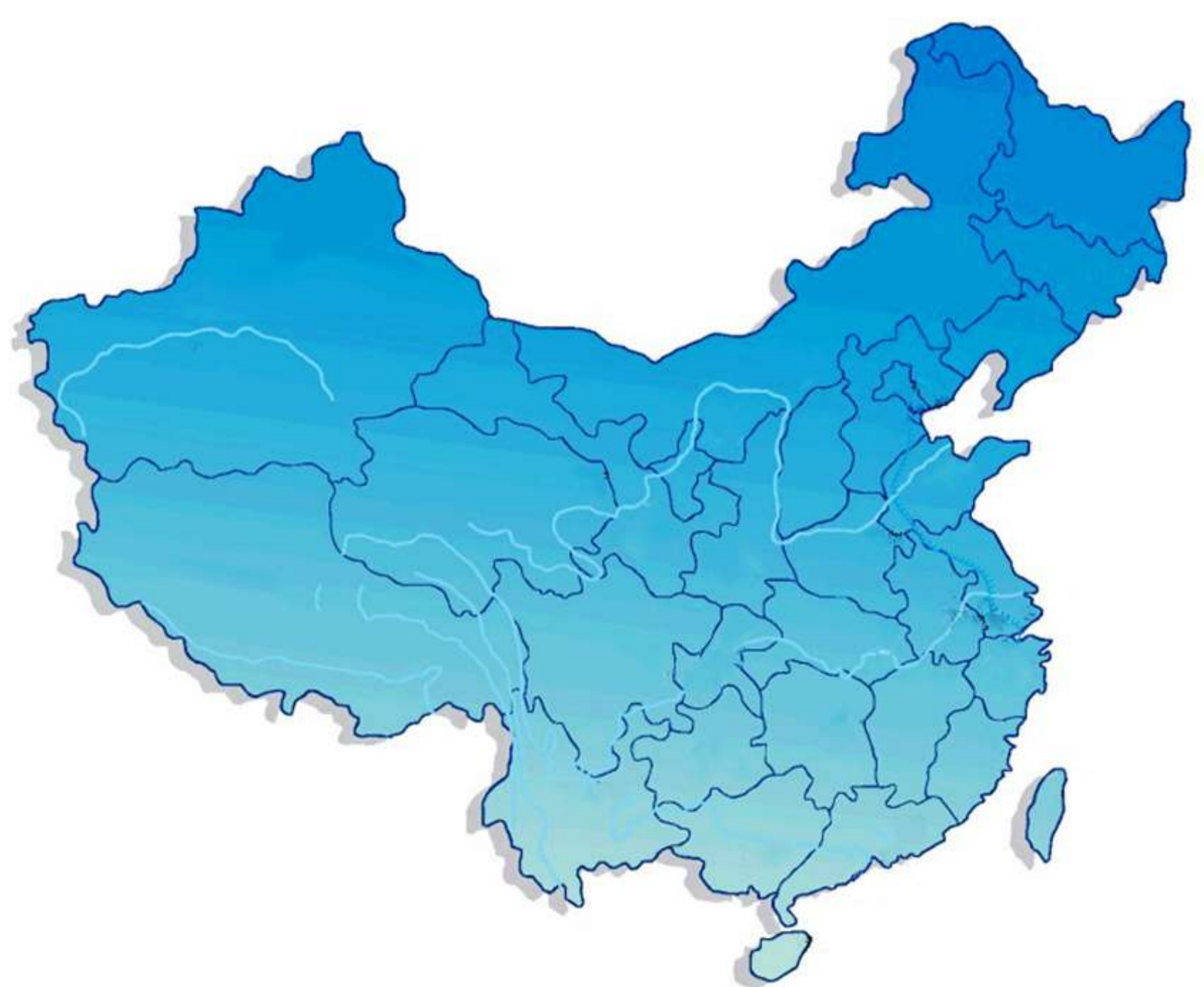

中国



中国采购总负责：欧阳朝日

我负责中国客户进口的采购跟踪与到货核对，不管仪器还是工控设备，备件，我都会一一与国外采购专员沟通与核实。以确保任何一个订单的准确性。



专注全球知名工业品牌贸易服务