

## ***Installation Instructions***

# **ControlLogix Power Supplies**

Catalog Numbers 1756-PA72 Series C, 1756-PB72 Series C, 1756-PA75 Series B, 1756-PB75 Series B, 1756-PH75 Series B, 1756-PC75 Series B

<b>Topic</b>	<b>Page</b>
Important User Information	2
Environment and Enclosure	3
Safety-related Programmable Electronic Systems	4
North American Hazardous Location Approval	4
European Hazardous Location Approval	5
Before You Begin	5
Install the Power Supply	6
Ground the Power Supply at Protective Earth Ground	8
Connect the Power	10
Remove the Protective Label	11
Activate the Power Supply	12
Determine the Input Power Requirements/Transformer Sizing	12
Status Indicators	14
Specifications	15
Additional Resources	23

## **About the Power Supplies**

ControlLogix power supplies are used with the 1756 chassis to provide 1.2V, 3.3V, 5V, and 24V DC power for all modules installed in the chassis. The non-redundant power supplies are mounted on the left end of the chassis, where they are plugged directly into the backplane.

## Important User Information

Solid state equipment has operational characteristics differing from those of electromechanical equipment. Safety Guidelines for the Application, Installation and Maintenance of Solid State Controls (Publication [SGI-1.1](#) available from your local Rockwell Automation sales office or online at <http://literature.rockwellautomation.com>) describes some important differences between solid state equipment and hard-wired electromechanical devices. Because of this difference, and also because of the wide variety of uses for solid state equipment, all persons responsible for applying this equipment must satisfy themselves that each intended application of this equipment is acceptable.





In no event will Rockwell Automation, Inc. be responsible or liable for indirect or consequential damages resulting from the use or application of this equipment.

The examples and diagrams in this manual are included solely for illustrative purposes. Because of the many variables and requirements associated with any particular installation, Rockwell Automation, Inc. cannot assume responsibility or liability for actual use based on the examples and diagrams.

No patent liability is assumed by Rockwell Automation, Inc. with respect to use of information, circuits, equipment, or software described in this manual.

Reproduction of the contents of this manual, in whole or in part, without written permission of Rockwell Automation, Inc., is prohibited.

Throughout this manual, when necessary, we use notes to make you aware of safety considerations.

<b>WARNING</b> 	Identifies information about practices or circumstances that can cause an explosion in a hazardous environment, which may lead to personal injury or death, property damage, or economic loss.
<b>IMPORTANT</b>	Identifies information that is critical for successful application and understanding of the product.
<b>ATTENTION</b> 	Identifies information about practices or circumstances that can lead to personal injury or death, property damage, or economic loss. Attentions help you identify a hazard, avoid a hazard and recognize the consequences.
<b>SHOCK HAZARD</b> 	Labels may be on or inside the equipment (for example, drive or motor) to alert people that dangerous voltage may be present.
<b>BURN HAZARD</b> 	Labels may be on or inside the equipment (for example, drive or motor) to alert people that surfaces may reach dangerous temperatures.

---

## Environment and Enclosure

---

**ATTENTION**

This equipment is intended for use in a Pollution Degree 2 industrial environment, in overvoltage Category II applications (as defined in IEC publication 60664-1), at altitudes up to 2000 m (6562 ft) without derating.

This equipment is considered Group 1, Class A industrial equipment according to IEC/CISPR Publication 11. Without appropriate precautions, there may be potential difficulties ensuring electromagnetic compatibility in other environments due to conducted as well as radiated disturbance.

This equipment is supplied as open-type equipment. It must be mounted within an enclosure that is suitably designed for those specific environmental conditions that will be present and appropriately designed to prevent personal injury resulting from accessibility to live parts. The enclosure must have suitable flame-retardant properties to prevent or minimize the spread of flame, complying with a flame spread rating of 5VA, V2, V1, V0 (or equivalent) if non-metallic. The interior of the enclosure must be accessible only by the use of a tool. Subsequent sections of this publication may contain additional information regarding specific enclosure type ratings that are required to comply with certain product safety certifications.

In addition to this publication, see:

- Industrial Automation Wiring and Grounding Guidelines, for additional installation requirements, Allen-Bradley publication [1770-4.1](#).
- NEMA Standards publication 250 and IEC publication 60529, as applicable, for explanations of the degrees of protection provided by different types of enclosure.

---

## Prevent Electrostatic Discharge

---

**ATTENTION**

This equipment is sensitive to electrostatic discharge, which can cause internal damage and affect normal operation. Follow these guidelines when you handle this equipment:

- Touch a grounded object to discharge potential static.
  - Wear an approved grounding wriststrap.
  - Do not touch connectors or pins on component boards.
  - Do not touch circuit components inside the equipment.
  - Use a static-safe workstation, if available.
  - Store the equipment in appropriate static-safe packaging when not in use.
-



## Safety-related Programmable Electronic Systems

**ATTENTION**



Personnel responsible for the application of safety-related programmable electronic systems (PES) shall be aware of the safety requirements in the application of the system and shall be trained in using the system.

## North American Hazardous Location Approval

The following information applies when operating this equipment in hazardous locations.	Informations sur l'utilisation de cet équipement en environnements dangereux.
<p>Products marked "CL I, DIV 2, GP A, B, C, D" are suitable for use in Class I Division 2 Groups A, B, C, D, Hazardous Locations and nonhazardous locations only. Each product is supplied with markings on the rating nameplate indicating the hazardous location temperature code. When combining products within a system, the most adverse temperature code (lowest "T" number) may be used to help determine the overall temperature code of the system. Combinations of equipment in your system are subject to investigation by the local Authority Having Jurisdiction at the time of installation.</p>	<p>Les produits marqués "CL I, DIV 2, GP A, B, C, D" ne conviennent qu'à une utilisation en environnements de Classe I Division 2 Groupes A, B, C, D dangereux et non dangereux. Chaque produit est livré avec des marquages sur sa plaque d'identification qui indiquent le code de température pour les environnements dangereux. Lorsque plusieurs produits sont combinés dans un système, le code de température le plus défavorable (code de température le plus faible) peut être utilisé pour déterminer le code de température global du système. Les combinaisons d'équipements dans le système sont sujettes à inspection par les autorités locales qualifiées au moment de l'installation.</p>
<p><b>WARNING</b></p> 	<p><b>EXPLOSION HAZARD -</b></p> <ul style="list-style-type: none"> <li>• Do not disconnect equipment unless power has been removed or the area is known to be nonhazardous. Do not disconnect equipment unless power has been removed or the area is known to be nonhazardous.</li> <li>• Do not disconnect connections to this equipment unless power has been removed or the area is known to be nonhazardous. Secure any external connections that mate to this equipment by using screws, sliding latches, threaded connectors, or other means provided with this product.</li> <li>• Substitution of components may impair suitability for Class I, Division 2.</li> <li>• If this product contains batteries, they must only be changed in an area known to be nonhazardous.</li> </ul>
<p><b>AVERTISSEMENT</b></p> 	<p><b>RISQUE D'EXPLOSION –</b></p> <ul style="list-style-type: none"> <li>• Couper le courant ou s'assurer que l'environnement est classé non dangereux avant de débrancher l'équipement.</li> <li>• Couper le courant ou s'assurer que l'environnement est classé non dangereux avant de débrancher les connecteurs. Fixer tous les connecteurs externes reliés à cet équipement à l'aide de vis, loquets coulissants, connecteurs filetés ou autres moyens fournis avec ce produit.</li> <li>• La substitution de composants peut rendre cet équipement inadapté à une utilisation en environnement de Classe I, Division 2.</li> <li>• S'assurer que l'environnement est classé non dangereux avant de changer les piles.</li> </ul>

---

## European Hazardous Location Approval

### 1756-PB72 Series C, 1756-PB75 Series B (only)

---

#### European Zone 2 Certification (The following applies when the product bears the Ex or EEx Marking)

---

This equipment is intended for use in potentially explosive atmospheres as defined by European Union Directive 94/9/EC and has been found to comply with the Essential Health and Safety Requirements relating to the design and construction of Category 3 equipment intended for use in potentially explosive atmospheres, given in Annex II to this Directive.

Compliance with the Essential Health and Safety Requirements has been assured by compliance with EN 60079-15 and EN 60079-0.

---

#### WARNING



- This equipment must be installed in an enclosure providing at least IP54 protection when applied in Zone 2 environments.
- This equipment shall be used within its specified ratings defined by Allen-Bradley.
- Provisions shall be made to prevent the rated voltage from being exceeded by transient disturbances of more than 40% when applied in Zone 2 environments.
- This equipment must be used only with ATEX certified backplanes.
- Secure any external connections that mate to this equipment by using screws, sliding latches, threaded connectors, or other means provided with this product.
- Do not disconnect equipment unless power has been removed or the area is known to be nonhazardous.

#### ATTENTION



This equipment is not resistant to sunlight or other sources of UV radiation.

---

## Before You Begin

Before you attempt to install a power supply, make sure you have the required tools.

### Required Tools

- 1/8" slotted screwdriver
- 1/4" slotted (#2) or Phillips screwdriver
- Torque screwdriver
- Needle-nose pliers
- Crimping tool

## Install the Power Supply

The chassis series you have determines what power supply you can use. The following table lists the chassis that is to be installed with a respective power supply.

### Chassis Compatibility

Power Supply Cat. No.	Chassis Cat. No.
1756-PA72 Series C	1756-A4, 1756-A7, 1756-A10, 1756-A13, 1756-A17 Series A, B
1756-PB72 Series C	
1756-PA75 Series B	1756-A4, 1756-A7, 1756-A10, 1756-A13, 1756-A17 Series B only
1756-PB75 Series B	
1756-PC75 Series B	
1756-PH75 Series B	

Follow these steps to install the power supply.

1. Align the power-supply circuit board with the card guides on the left side of the chassis.

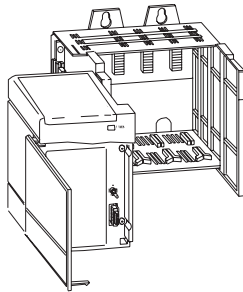

20264a-M

2. Guide the extended tab on the power-supply circuit board into the notch of the chassis.

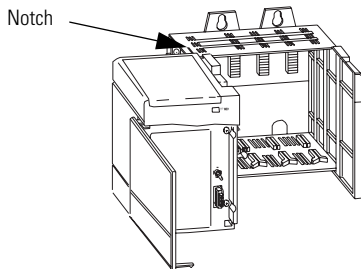

43614

- Slide the power supply in until it is flush with the back of the chassis.

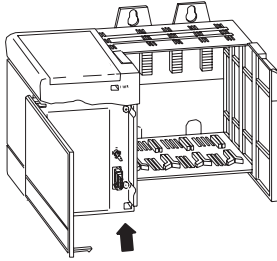

44144

- Fasten the power supply to the chassis.

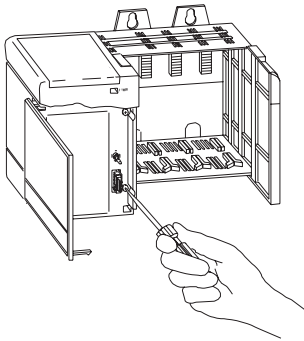

44145

## Ground the Power Supply at Protective Earth Ground

The following steps describe how to connect the equipment-protective earth ground from the power supply to the chassis.

1. Connect the equipment-protective earth ground from the power supply to the chassis.
2. Connect the protective-earth ground from the chassis to the system earth ground.
3. Tighten the nut on the equipment-protective earth ground terminal stud to a torque of 1.4 N•m (12 lb•in).

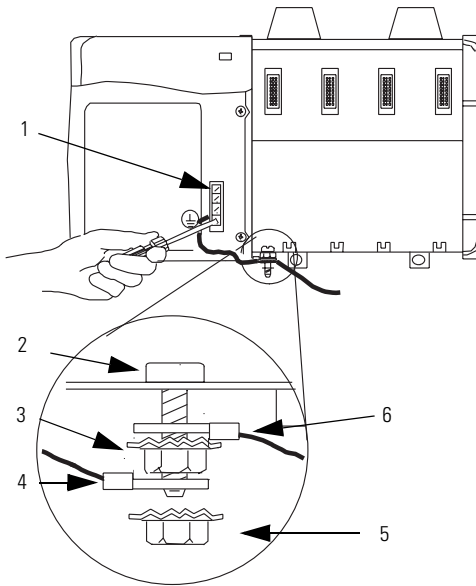

44146

Item	Description
1	Wiring terminal block
2	Protective earth-ground terminal stud
3	Nut with captive star washer
4	Equipment grounding conductor (ground lug with 2.1 mm <sup>2</sup> [14 AWG] wire) protective earth ground from wiring terminal block to chassis
5	Nut with captive star washer
6	Equipment grounding conductor (ground lug with 2.1 mm <sup>2</sup> [14 AWG] wire) protective earth ground from chassis to ground bus



## Verify the Grounding Configuration

Before continuing, verify that the Protective and Functional Earth grounds are connected to the system. We recommend that you use a ground bus to reduce the electrical resistance at the connection.

**TIP**

Keep wire lengths as short as possible.

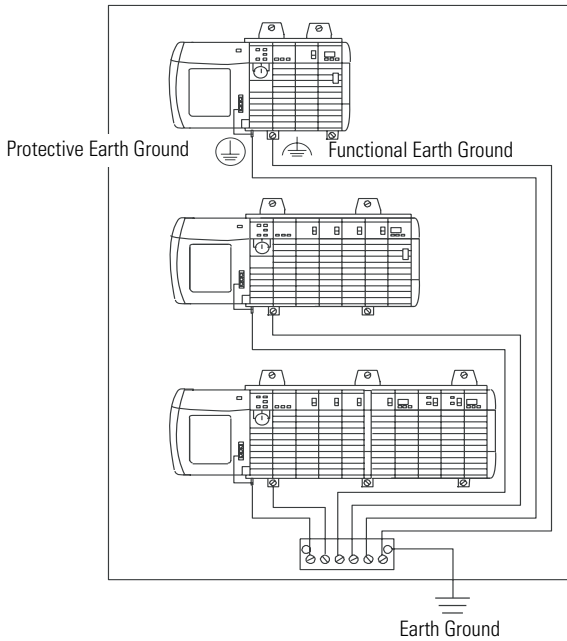

For more information on grounding the wiring to the ControlLogix chassis, refer to the ControlLogix Chassis-Series B Installation Instructions, publication [1756-IN080](#).

## Connect the Power

**WARNING**



If you connect or disconnect wiring while the field-side power is on, an electrical arc can occur. This could cause an explosion in hazardous location installations. Be sure that power is removed or the area is nonhazardous before proceeding.

Use 2.5 mm<sup>2</sup> (14 AWG) 75 °C (167 °F) copper wire with 1.2 mm (3/64-in.) insulation to connect power. Follow these steps for each wire (high side (L1), low side (L2/N), and ground) to connect power.

1. Turn the screw counterclockwise to open the wiring terminal.

**IMPORTANT**

The third terminal from the top (between low side and ground) is not used on the 1756 power supplies.

**1756-PA72 Series C, 1756-PA75 Series B (AC Power Supplies)**

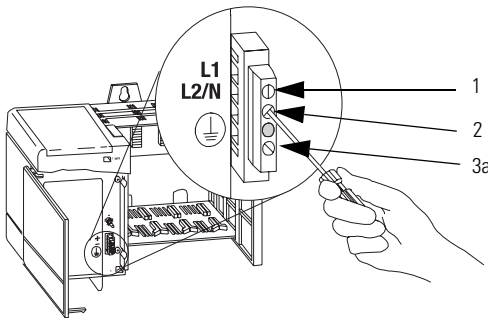

43894

**1756-PB72 Series C, 1756-PB75 Series B, 1756-PH75 Series B, 1756-PC75 Series B (DC Power Supplies)**

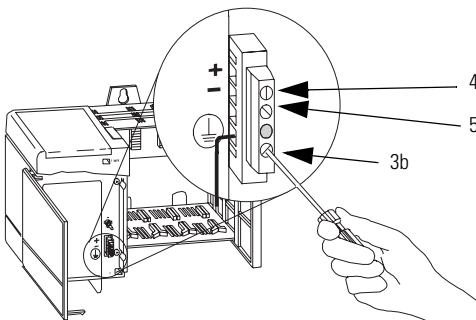

43632

## Power Supply Connections

Item	Description	
1	L1 - High side of line power	AC Power Supplies
2	L2/N- Low side of line power	
3 a	Protective earth-ground terminal	
3 b	Protective earth-ground terminal	DC Power Supplies
4	DC +	
5	DC -	

2. Insert the wire into the terminal.
3. Turn the screw clockwise to tighten the terminal on the wire.
4. Tighten the terminals to a torque of 0.8 N•m (7 lb•in).

## Remove the Protective Label

### ATTENTION



Make sure the chassis is mounted and all panel fabrication is complete before you remove the protective label. This label protects the power supply from metal shavings falling inside the power supply and damaging it during operation.

Remove the plastic label from the top of the power supply.

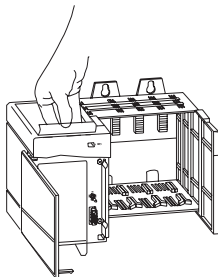

20264b-M

## Activate the Power Supply

Flip the power switch to the up position to turn the power supply on.

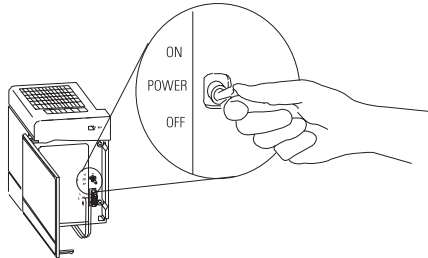

43615

## Determine the Input Power Requirements/Transformer Sizing

These graphs show the input power requirements for the power supplies, given the power they are providing to the modules in the chassis.

The vertical axis of each graph shows the backplane power consumed by all of the modules in the chassis; the horizontal axis shows input power requirements of the power supply.

**1756-PA72 Series C, 1756-PA75 Series B (AC)**

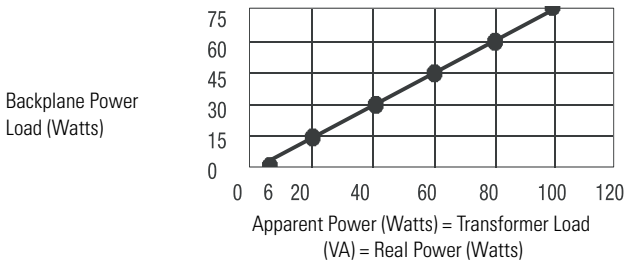

43895

**1756-PB72 Series C, 1756-PB75 Series B (DC)**

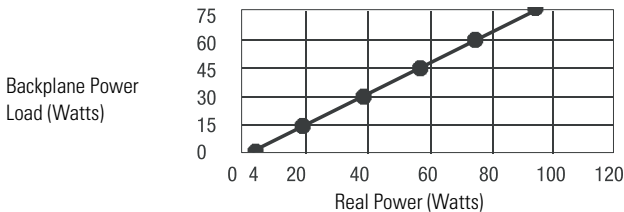

43896

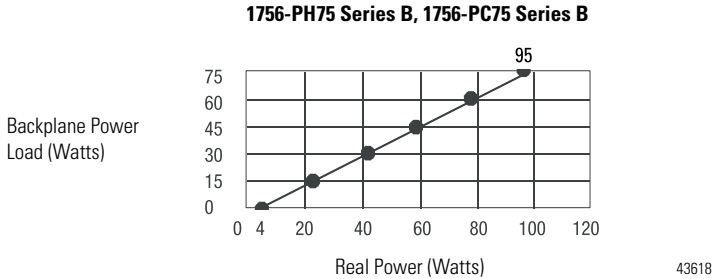

To use the graphs, complete this procedure.

1. Add all of the backplane power, that is, Watts, for all of the modules in the chassis.
2. Find the number from step 1 on the vertical axis.
3. Follow that value to the right until it intersects the line on the graph.
4. Find the associated input-power rating consumed by the power supply on the horizontal axis.

For example, if the power consumption of all of the modules in the chassis is 30 Watts, a 1756-PH75 series B power supply consumes approximately 42 Watts of Real Power.

## Status Indicators

ControlLogix power supplies have a green status indicator that remains ON during normal operation.

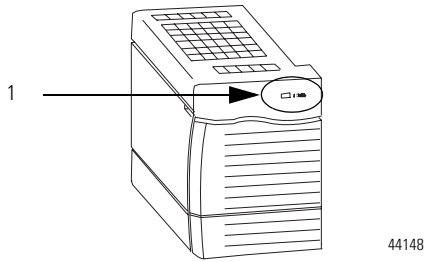

Item	Description
1	Status indicator

If the indicator turns OFF during operation, follow these steps.

1. Verify that the line voltage is within the specified range.
2. If the indicator remains OFF, cycle line power OFF.
3. Loosen the screws holding the power supply to the chassis.  
See [page 7](#) for the location of the screws on the power supply.
4. Slide the power supply out so that the rear connector is disconnected.
5. Reapply input power.
6. If the indicator:
  - turns ON:
    - a. Verify that the module loads in the system are within the output rating of the power supply.
    - b. Power down the power supply.
    - c. Reinstall the power supply in the chassis.
  - turns OFF, return the power supply to your local Rockwell Automation distributor.

# Specifications

## AC Power Supplies

### 1756-PA72 Series C, 1756-PA75 Series B - Technical Specifications

Attribute	1756-PA72 Series C	1756-PA75 Series B
Dimensions (HxWxD), approx.	140 x 112 x 145 mm (5.5 x 4.4 x 5.7 in.)	
Weight, approx.	0.95 kg (2.10 lb)	
Module location	Left side of 1756 chassis	
Chassis	1756-A4, 1756-A7, 1756-A10, 1756-A13, 1756-A17	
Chassis compatibility	Series A Series B	Series B
Input voltage range	85...265V AC	
Input voltage, nom	120/240V AC	
Input frequency range	47...63 Hz	
Apparent input power	100VA	
Input power, max	100VA 100 W	
Output power, max <sup>(1)</sup>	75 W @ 60 °C (140 °F)	
Power dissipation	85.3 BTU/hr	
Power consumption	25 W @ 60 °C (140 °F)	
Hold up time <sup>(2)</sup>	5 cycles @ 85V AC, 50/60 Hz 6 cycles @ 120V AC, 50/60 Hz 6 cycles @ 200V AC, 50/60 Hz 6 cycles @ 240V AC, 50/60 Hz	
Inrush current, max	20 A	
Current capacity at 1.2V	1.5 A	
Current capacity at 3.3V	4 A	
Current capacity at 5.1V	10 A	13 A
Current capacity at 24V	2.8 A	
Overcurrent protection, max <sup>(3)</sup>	15 A, user-supplied	
Fusing <sup>(4)</sup>	Non-replaceable fuse is soldered in place	
Transformer load, max	100VA	
Isolation voltage	250V (continuous), reinforced insulation type Type tested at 3500V DC for 60 s, Power Input to Backplane.	
Wire size	2.5 mm <sup>2</sup> (14 AWG) solid or stranded copper wire rated at 75 °C (167 °F), or greater, 1.2 mm (3/64 in.) insulation max	

**1756-PA72 Series C, 1756-PA75 Series B - Technical Specifications**

Attribute	1756-PA72 Series C	1756-PA75 Series B
Wire category	1 <sup>(5)</sup> on power ports	
North American temp code	T4	
Mounting screw torque	0.8 N•m (7 lb•in)	

- (1) The combination of all output power (1.2V, 3.3V, 5.1V, and 24V) cannot exceed 75 W.
- (2) The hold up time is all the time between input voltage removal and DC power failure.
- (3) Use time-delay type overcurrent protection in all ungrounded conductors.
- (4) This fuse is intended to guard against fire hazard due to short circuit conditions.
- (5) Use this Conductor Category information for planning conductor routing. Refer to Industrial Automation Wiring and Grounding Guidelines, publication [1770-4.1](#).

**1756-PA72 Series C, 1756-PA75 Series B - Environmental Specifications**

Attribute	1756-PA72 Series C	1756-PA75 Series B
Operating temperature IEC 60068-2-1 (Test Ad, Operating Cold) IEC 60068-2-2 (Test Bd, Operating Dry Heat) IEC 60068-2-14 (Test Nb, Operating Thermal Shock)	0...60 °C (32...140 °F)	
Nonoperating temperature IEC 60068-2-1 (Test Ab, Unpackaged Nonoperating Cold) IEC 60068-2-2 (Test Bb, Unpackaged Nonoperating Dry Heat) IEC 60068-2-14 (Test Na, Unpackaged Nonoperating Thermal Shock)	-40...85 °C (-40...185 °F)	
Relative humidity IEC 60068-2-30 (Test Db, Unpackaged Nonoperating Damp Heat)	5...95% noncondensing	
Vibration IEC 60068-2-6 (Test Fc, Operating)	2 g @ 10...500 Hz	
Operating shock IEC 60068-2-27 (Test Ea, Unpackaged Shock)	30 g	
Nonoperating shock IEC 60068-2-27 (Test Ea, Unpackaged Shock)	50 g	
Emissions CISPR 11	Group 1, Class A	
ESD immunity IEC 61000-4-2	6 kV contact discharges 8 kV air discharges	



## 1756-PA72 Series C, 1756-PA75 Series B - Environmental Specifications

Attribute	1756-PA72 Series C	1756-PA75 Series B
Radiated RF immunity IEC 61000-4-3	10V/m with 1 kHz sine-wave 80% AM from 80...2000 MHz 10V/m with 200 Hz 50% Pulse 100% AM at 900 MHz 10V/m with 200 Hz 50% Pulse 100% AM at 1890 MHz 3V/m with 1 kHz sine-wave 80% AM from 2000...2700 MHz	
Conducted RF immunity IEC 6100-4-6	10V rms with 1 kHz sine-wave 80% AM from 150 kHz...80 MHz	
EFT/B immunity IEC 61000-4-4	±4 kV at 5 kHz on power ports	
Surge transient immunity IEC 61000-4-5	±1 kV line-line (DM) and ±2 kV line-earth (CM) on power ports	
Oscillatory surge withstand IEEE C37.90.1	3 kV	
Enclosure type rating	None (open style)	
Voltage variation IEC 61000-4-11	30% dips for 1 period at 0° and 80° on AC supply ports 60% dips for 5 and 50 periods on AC supply ports ±10% fluctuations for 15 min on AC supply ports >95% interruptions for 250 periods on AC supply ports	

## 1756-PA72 Series C, 1756-PA75 Series B - Certifications<sup>(1)</sup>

Certifications <sup>(2)</sup>	1756-PA72 Series C	1756-PA75 Series B
UL	UL Listed Industrial Control Equipment. See UL File E65584	
CSA	Certified Process Control Equipment. See CSA File LR54689C	
CSA	Certified Process Control Equipment for Class I, Division 2 Group A,B,C,D Hazardous Locations. See CSA File LR69960C	
FM	Approved Equipment for use in Class 1 Division 2 Group A,B,C,D Hazardous Locations	
CE	European Union 2004/108/EC EMC Directive, compliant with: EN 61326-1; Meas./Control/Lab., Industrial Requirements EN61000-6-2; Industrial Immunity EN61000-6-4; Industrial Emissions EN61131-2; Programmable Controllers (Clause 8, Zone A,B, C) European Union 2006/95/EC LVD, compliant with: EN 61131-2; Programmable Controllers (Clause 11)	
C-Tick	Australian Radio Communications Act, compliant with: AS/NZS CISPR 11; Industrial Emissions	
TÜV	TÜV Certified for Functional Safety: up to and including SIL 2 ( <b>1756-PA75 only</b> )	

<sup>(1)</sup> When product is marked.

<sup>(2)</sup> See the Product Certification link at <http://www.ab.com> for Declarations of Conformity, Certificates, and other certification details.

## DC Power Supplies

### 1756-PB72 Series C, 1756-PB75 Series B, 1756-PC75 Series B, 1756-PH75 Series B - Technical Specifications

Attribute	1756-PB72 Series C	1756-PB75 Series B	1756-PC75 Series B	1756-PH75 Series B
Dimensions (HxWxD), approx.	140 x 112 x 145 mm (5.5 x 4.4 x 5.7 in.)			
Weight, approx.	0.95 kg (2.10 lb)			
Module location	Left side of 1756 chassis			
Chassis	1756-A4, 1756-A7, 1756-A10, 1756-A13, 1756-A17			
Chassis compatibility	Series A Series B	Series B		
Input voltage range	18...32V DC <sup>(1)</sup>		30...60V DC	90...143V DC
Input voltage, nom	24V DC		48V DC	125V DC
Input power, max	95 W			
Output power, max	75 W @ 60 °C (140 °F) <sup>(2)</sup>			
Power dissipation	68.2 BTU/hr			
Power consumption	20 W @ 60 °C (140 °F)			
Hold up time	35 ms @ 18V DC <sup>(3)</sup> 40 ms @ 24V DC 40 ms @ 32V DC		50 ms @ 30...60V DC <sup>(3)</sup>	50 ms @ 30...143V DC <sup>(3)</sup>
Inrush current, max	30 A		20 A	
Current capacity at 1.2V	1.5 A			
Current capacity at 3.3V	4 A			
Current capacity at 5.1V	10 A	13 A		
Current capacity at 24V	2.8 A			
User-supplied overcurrent protection, max	15 A <sup>(4)</sup>			
Fusing	Non-replaceable fuse is soldered in place <sup>(5)</sup>			
Isolation voltage	250V (continuous), reinforced insulation type Type tested at 3500V DC for 60 s, power input to backplane			
Wire category	1 <sup>(6)</sup> on power ports			
Wire size	2.5 mm <sup>2</sup> (14 AWG) solid or stranded copper wire rated at 75 °C (167 °F), or greater, 1.2 mm (3/64 in.) insulation max			

## 1756-PB72 Series C, 1756-PB75 Series B, 1756-PC75 Series B, 1756-PH75 Series B - Technical Specifications

Attribute	1756-PB72 Series C	1756-PB75 Series B	1756-PC75 Series B	1756-PH75 Series B
North American temp code	T4			
IEC temp code	T4		N/A	
Mounting screw torque	0.8 N•m (7 lb•in)			

- (1) Input may drop to 16V for a maximum of two minutes each hour for motor starting.
- (2) The combination of all output power (1.2V, 3.3V, 5.1V, and 24V) cannot exceed 75 W.
- (3) The hold up time is the time between input voltage removal and DC power failure.
- (4) Use time-delay type overcurrent protection in all ungrounded conductors.
- (5) This fuse is intended to guard against fire hazard due to short circuit conditions.
- (6) Use this Conductor Category information for planning conductor routing. Refer to Industrial Automation Wiring and Grounding Guidelines, publication [1770-4.1](#).

## 1756-PB72 Series C, 1756-PB75 Series B, 1756-PC75 Series B, 1756-PH75 Series B - Environmental Specifications

Attribute	1756-PB72 Series C	1756-PB75 Series B	1756-PC75 Series B	1756-PH75 Series B
Operating temperature	0...60 °C (32...140 °F)			
IEC 60068-2-1 (Test Ad, Operating Cold)				
IEC 60068-2-2 (Test Bd, Operating Dry Heat)				
IEC 60068-2-14 (Test Nb, Operating Thermal Shock)				

**1756-PB72 Series C, 1756-PB75 Series B, 1756-PC75 Series B, 1756-PH75 Series B - Environmental Specifications**

<b>Attribute</b>	<b>1756-PB72 Series C</b>	<b>1756-PB75 Series B</b>	<b>1756-PC75 Series B</b>	<b>1756-PH75 Series B</b>
Nonoperating temperature  IEC 60068-2-1 (Test Ab, Unpackaged Nonoperating Cold)  IEC 60068-2-2 (Test Bb, Unpackaged Nonoperating Dry Heat)  IEC 60068-2-14 (Test Na, Unpackaged Nonoperating Thermal Shock)	-40...85 °C (-40...185 °F)			
Relative humidity  IEC 60068-2-30 (Test Db, Unpackaged Nonoperating Damp Heat)	5...95% noncondensing			
Vibration  IEC 60068-2-6 (Test Fc, Operating)	2 g @ 10...500 Hz			
Operating shock  IEC 60068-2-27 (Test Ea, Unpackaged Shock)	30 g			
Nonoperating shock  IEC 60068-2-27 (Test Ea, Unpackaged Shock)	50 g			
ESD immunity  IEC 61000-4-2	6 kV contact discharges 8 kV air discharges			
Emissions  CISPR 11	Group 1, Class A			

## 1756-PB72 Series C, 1756-PB75 Series B, 1756-PC75 Series B, 1756-PH75 Series B - Environmental Specifications

Attribute	1756-PB72 Series C	1756-PB75 Series B	1756-PC75 Series B	1756-PH75 Series B
Radiated RF immunity IEC 61000-4-3	10V/m with 1 kHz sine-wave 80% AM from 80...2000 MHz  10V/m with 200 Hz 50% Pulse 100% AM at 900 MHz  10V/m with 200 Hz 50% Pulse 100% AM at 1890 MHz  3V/m with 1 kHz sine-wave 80% AM from 2000...2700 MHz		10V/m with 1 kHz sine-wave 80% AM from 80...2000 MHz  10V/m with 200 Hz 50% Pulse 100% AM at 900 MHz  10V/m with 200 Hz 50% Pulse 100% AM at 1890 MHz  1V/m with 1 kHz sine-wave 80% from 2000...2700 MHz	
Conducted RF immunity  IEC 6100-4-6	10V rms with 1 kHz sine-wave 80% AM from 150 kHz...80 MHz			
EFT/B immunity IEC 61000-4-4	±4 kV at 5 kHz on power ports			
Surge transient immunity  IEC 61000-4-5	±1 kV line-line (DM) and ±2 kV line-earth (CM) on power ports			
Oscillatory surge withstand  IEEE C37.90.1	N/A		3 kV	
Enclosure type rating	None (open style)			
Voltage variation IEC 61000-4-11  IEC 61000-4-29	60% dips for 100 ms on DC supply ports 100% dips for 50 ms on DC supply ports ±20% fluctuations for 15 min on DC supply ports 5 s interruptions on DC supply ports 10 ms interruption on DC supply ports			

## 1756-PB72 Series C, 1756-PB75 Series B - Certifications<sup>(1)</sup>

Certifications <sup>(2)</sup>	1756-PB72 Series C	1756-PB75 Series B
c-UL-us	UL Listed Industrial Control Equipment, certified for US and Canada, See File E65584	
c-UL-us	UL Listed for Class 1, Division 2 Group A,B,C,D Hazardous Locations, certified for U.S. and Canada. See UL File E194810	
CSA	CSA Certified Process Control Equipment. See CSA File LR54689C	
CSA	CSA Certified Process Control Equipment for Class I, Division 2 Group A,B,C,D Hazardous Locations. See CSA File LR69960C	
FM	FM Approved Equipment for use in Class 1 Division 2 Group A, B, C, D Hazardous Locations	

**1756-PB72 Series C, 1756-PB75 Series B - Certifications<sup>(1)</sup>**

<b>Certifications<sup>(2)</sup></b>	<b>1756-PB72 Series C</b>	<b>1756-PB75 Series B</b>
CE	European Union 2004/108/EC EMC Directive, compliant with: EN 61326-1; Meas./Control/Lab., Industrial Requirements EN 61000-6-2; Industrial Immunity EN 61000-6-4; Industrial Emissions EN61131-2; Programmable Controllers (Clause 8, Zone A, B, & C) European Union 2006/95/EC LVD, compliant with: EN 61131-2; Programmable Controllers (Clause 11)	
C-Tick	Australian Radio Communications Act, compliant with: AS/NZS CISPR 11; Industrial Emissions	
Ex	European Union 94/9/EC ATEX Directive, compliant with: EN 60079-15; Potentially Explosive Atmospheres, Protection "n" (II 3 G Ex nA IIC T4 X) EN 60079-0; General Requirements (Zone 2)	
TÜV	TÜV Certified for Functional Safety: up to and including SIL 2 ( <b>1756-PB75 only</b> )	

<sup>(1)</sup> When product is marked.

<sup>(2)</sup> See the Product Certification link at <http://www.ab.com> for Declarations of Conformity, Certificates, and other certification details.

**1756-PC75 Series B, 1756-PH75 Series B - Certifications<sup>(1)</sup>**

<b>Certifications<sup>(2)</sup></b>	<b>1756-PC75 Series B</b>	<b>1756-PH75 Series B</b>
UL	UL Listed Industrial Control Equipment. See UL File E65584	
CSA	CSA Certified Process Control Equipment. See CSA File LR54689C	
CSA	CSA Certified Process Control Equipment for Class I, Division 2 Group A,B,C,D Hazardous Locations. See CSA File LR69960C	
CE	European Union 2004/108/EC EMC Directive, compliant with: EN 61326-1; Meas./Control/Lab., Industrial Requirements EN 61000-6-2; Industrial Immunity EN 61000-6-4; Industrial Emissions EN61131-2; Programmable Controllers (Clause 8, Zone A, B, & C) European Union 2006/95/EC LVD, compliant with: EN 61131-2; Programmable Controllers (Clause 11)	
C-Tick	Australian Radio Communications Act, compliant with: AS/NZS CISPR 11; Industrial Emissions	
TÜV	TÜV Certified for Functional Safety: up to and including SIL 2	

<sup>(1)</sup> When product is marked.

<sup>(2)</sup> See the Product Certification link at <http://www.ab.com> for Declarations of Conformity, Certificates, and other certification details.

## Additional Resources

These documents contain additional information concerning related Rockwell Automation products.

<b>Resource</b>	<b>Description</b>
1756-A4, 1756-A7, 1756-A10, 1756-A13, 1756-A17 ControlLogix Chassis Installation Instructions, publication <a href="#">1756-IN080</a>	Provides information about installing a ControlLogix chassis and technical specifications.
Industrial Automation Wiring and Grounding Guidelines, publication <a href="#">1770-4.1</a>	Provides general guidelines for installing a Rockwell Automation industrial system.
Product Certifications website, <a href="http://www.ab.com">http://www.ab.com</a>	Provides declarations of conformity, certificates, and other certification details.
ControlLogix Selection Guide, publication <a href="#">1756-SG001</a>	Provides overview of the ControlLogix system and its products.

You can view or download publications at <http://literature.rockwellautomation.com>. To order paper copies of technical documentation, contact your local Rockwell Automation distributor or sales representative.

# Rockwell Automation Support

Rockwell Automation provides technical information on the Web to assist you in using its products. At <http://support.rockwellautomation.com>, you can find technical manuals, a knowledge base of FAQs, technical and application notes, sample code and links to software service packs, and a MySupport feature that you can customize to make the best use of these tools.

For an additional level of technical phone support for installation, configuration and troubleshooting, we offer TechConnect support programs. For more information, contact your local distributor or Rockwell Automation representative, or visit <http://support.rockwellautomation.com>.

## Installation Assistance

If you experience a problem within the first 24 hours of installation, please review the information that's contained in this manual. You can also contact a special Customer Support number for initial help in getting your product up and running.

United States	1.440.646.3434 Monday – Friday, 8 a.m. – 5 p.m. EST
Outside United States	Please contact your local Rockwell Automation representative for any technical support issues.

## New Product Satisfaction Return

Rockwell Automation tests all of its products to ensure that they are fully operational when shipped from the manufacturing facility. However, if your product is not functioning and needs to be returned, follow these procedures.

United States	Contact your distributor. You must provide a Customer Support case number (call the phone number above to obtain one) to your distributor in order to complete the return process.
Outside United States	Please contact your local Rockwell Automation representative for the return procedure.

Allen-Bradley, ControlLogix, Rockwell Automation, and TechConnect are trademarks of Rockwell Automation, Inc.

Trademarks not belonging to Rockwell Automation are property of their respective companies.

[www.rockwellautomation.com](http://www.rockwellautomation.com)

### Power, Control and Information Solutions Headquarters

Americas: Rockwell Automation, 1201 South Second Street, Milwaukee, WI 53204-2496 USA, Tel: (1) 414.382.2000, Fax: (1) 414.382.4444

Europe/Middle East/Africa: Rockwell Automation, Vorstlaan/Boulevard du Souverain 36, 1170 Brussels, Belgium, Tel: (32) 2 663 0600, Fax: (32) 2 663 0640

Publication 1756-IN613A-EN-P - December 2008

PN 33792

Supersedes Publications 1756-IN078B-EN-P-February 2005, 1756-IN596A-EN-P-December 2004, 1756-IN589A-EN-P-January 2004, 1756-IN597A-EN-P-August 2004  
Copyright © 2008 Rockwell Automation, Inc. All rights reserved. Printed in the U.S.A.